

## 1200V / 10A

## Molded Package

### ■ Features

- Small molded package
- Low power loss
- Soft switching with low switching surge and noise
- High reliability, high ruggedness (RBSOA, SCSOA etc.)
- Comprehensive line-up

### ■ Applications

- Inverter for Motor drive
- AC and DC Servo drive amplifier
- Uninterruptible power supply

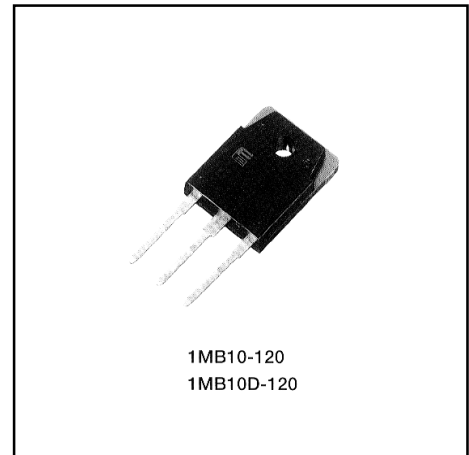

### ■ Maximum ratings and characteristics

- Absolute maximum ratings (at  $T_c=25^{\circ}\text{C}$  unless otherwise specified)

#### 1MB10-120 / IGBT

Item	Symbol	Rating	Unit		
Collector-Emitter voltage	$V_{CES}$	1200	V		
Gate-Emitter voltage	$V_{GES}$	$\pm 20$	V		
Collector current	DC	$T_c=25^{\circ}\text{C}$	$I_{c25}$	16	A
		$T_c=100^{\circ}\text{C}$	$I_{c100}$	10	A
	1ms	$T_c=25^{\circ}\text{C}$	$I_{cp}$	48	A
Max. power dissipation(IGBT)	$P_c$	135	W		
Operating temperature	$T_j$	+150	$^{\circ}\text{C}$		
Storage temperature	$T_{stg}$	-40 to +150	$^{\circ}\text{C}$		
Screw torque	-	50	N-cm		

#### 1MB10D-120 / IGBT+FWD

Item	Symbol	Rating	Unit		
Collector-Emitter voltage	$V_{CES}$	1200	V		
Gate-Emitter voltage	$V_{GES}$	$\pm 20$	V		
Collector current	DC	$T_c=25^{\circ}\text{C}$	$I_{c25}$	16	A
		$T_c=100^{\circ}\text{C}$	$I_{c100}$	10	A
	1ms	$T_c=25^{\circ}\text{C}$	$I_{cp}$	48	A
Max. power dissipation (IGBT)	$P_c$	135	W		
Max. power dissipation (FWD)	$P_c$	85	W		
Operating temperature	$T_j$	+150	$^{\circ}\text{C}$		
Storage temperature	$T_{stg}$	-40 to +150	$^{\circ}\text{C}$		
Screw torque	-	50	N-cm		

### ■ Equivalent Circuit Schematic

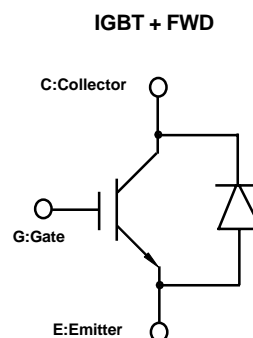
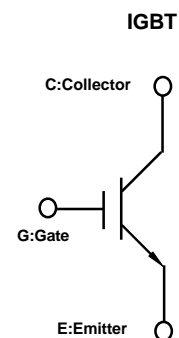

● Electrical characteristics (at Tj=25°C unless otherwise specified)

1MB10-120 / IGBT

Item	Symbol	Characteristics			Conditions	Unit
		Min.	Typ.	Max.		
Zero gate voltage collector current	ICES	–	–	1.0	VGE=0V, VCE=1200V	mA
Gate-Emitter leakage current	IGES	–	–	20	VCE=0V, VGE=±20V	µA
Gate-Emitter threshold voltage	VGE(th)	5.5	–	8.5	VCE=20V, IC=10mA	V
Collector-Emitter saturation voltage	VCE(sat)	–	–	3.5	VGE=15V, IC=10A	V
Input capacitance	Cies	–	1200	–	VGE=0V	pF
Output capacitance	Coes	–	250	–	VCE=10V	
Reverse transfer capacitance	Cres	–	80	–	f=1MHz	
Turn-on time	ton	–	–	1.2	VCC=600V IC=10A	µs
	tr	–	–	0.6	VGE=±15V	
Turn-off time	toff	–	–	1.5	RG=160 ohm	
	tf	–	–	0.5	(Half Bridge)	

1MB10D-120 / IGBT+FWD

Item	Symbol	Characteristics			Conditions	Unit
		Min.	Typ.	Max.		
Zero gate voltage collector current	ICES	–	–	1.0	VGE=0V, VCE=1200V	mA
Gate-Emitter leakage current	IGES	–	–	20	VCE=0V, VGE=±20V	µA
Gate-Emitter threshold voltage	VGE(th)	5.5	–	8.5	VCE=20V, IC=10mA	V
Collector-Emitter saturation voltage	VCE(sat)	–	–	3.5	VGE=15V, IC=10A	V
Input capacitance	Cies	–	1200	–	VGE=0V	pF
Output capacitance	Coes	–	250	–	VCE=10V	
Reverse transfer capacitance	Cres	–	80	–	f=1MHz	
Turn-on time	ton	–	–	1.2	VCC=600V, IC=10A	µs
	tr	–	–	0.6	VGE=±15V	
Turn-off time	toff	–	–	1.5	RG=160 ohm	
	tf	–	–	0.5	(Half Bridge)	
FWD forward on voltage	VF	–	–	3.0	IF=10A, VGE=0V	V
Reverse recovery time	trr	–	–	0.35	IF=10A, VGE=-10V, di/dt=100A/µs	µs

● Thermal resistance characteristics

1MB10-120 / IGBT

Item	Symbol	Characteristics			Conditions	Unit
		Min.	Typ.	Max.		
Thermal resistance	Rth(j-c)	–	–	0.92	IGBT	°C/W

1MB10D-120 / IGBT+FWD

Item	Symbol	Characteristics			Conditions	Unit
		Min.	Typ.	Max.		
Thermal resistance	Rth(j-c)	–	–	0.92	IGBT	°C/W
	Rth(j-c)	–	–	1.47	FWD	°C/W

■ Outline drawings, mm

1MB10-120, 1MB10D-120

TO-3P

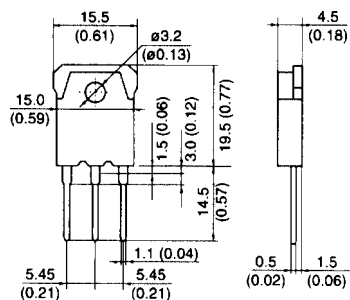

Characteristics

1MB10-120, 1MB10D-120

Collector current vs. Collector-Emitter voltage  
T<sub>j</sub>=25°C

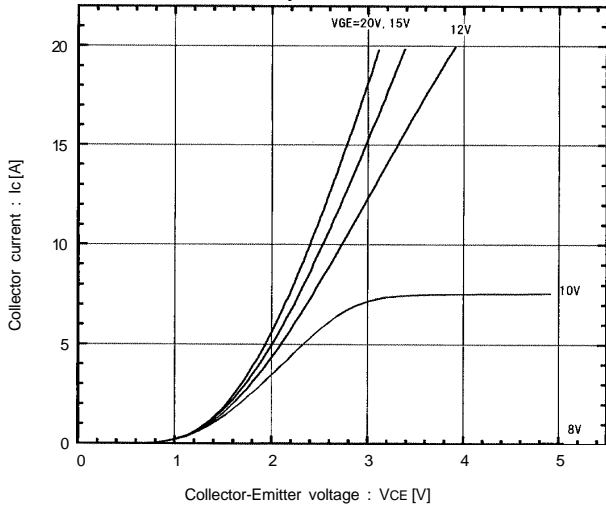

Collector current vs. Collector-Emitter voltage  
T<sub>j</sub>=125°C

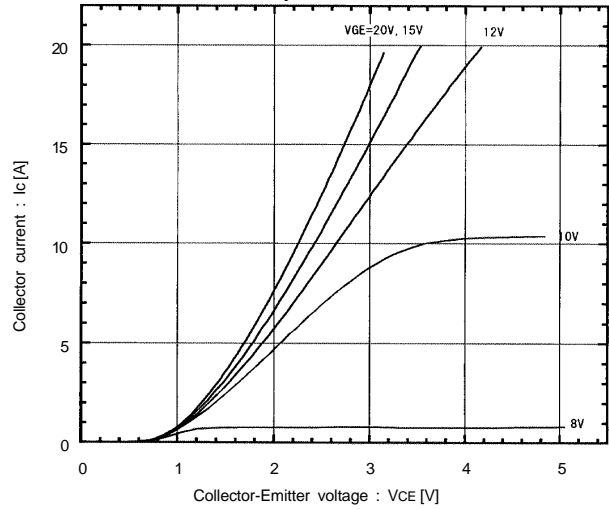

Collector-Emitter vs. Gate-Emitter voltage  
T<sub>j</sub>=25°C

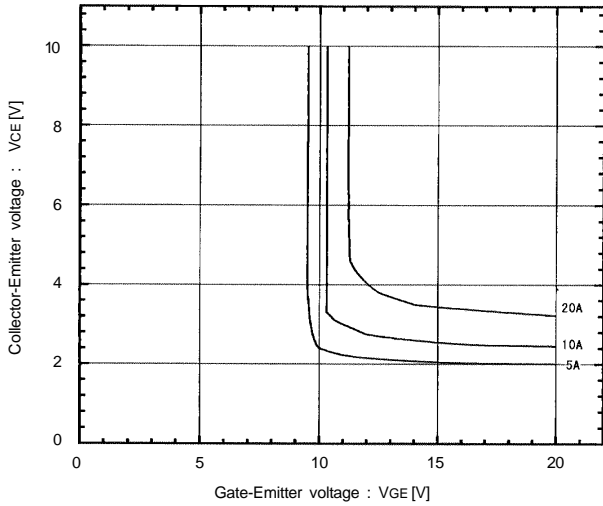

Collector-Emitter vs. Gate-Emitter voltage  
T<sub>j</sub>=125°C

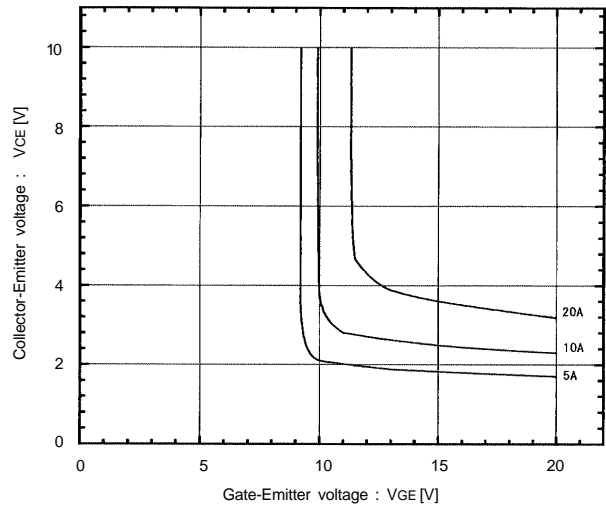

Switching time vs. Collector current  
V<sub>CC</sub>=600V, R<sub>G</sub>=160 ohm, V<sub>GE</sub>=±15V, T<sub>j</sub>=25°C

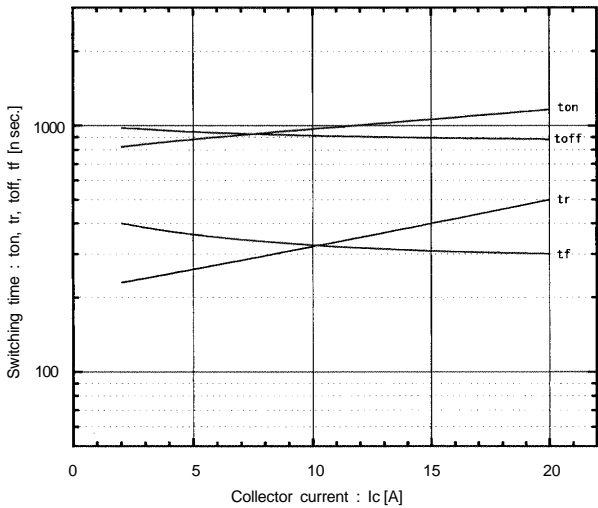

Switching time vs. Collector current  
V<sub>CC</sub>=600V, R<sub>G</sub>=160 ohm, V<sub>GE</sub>=±15V, T<sub>j</sub>=125°C

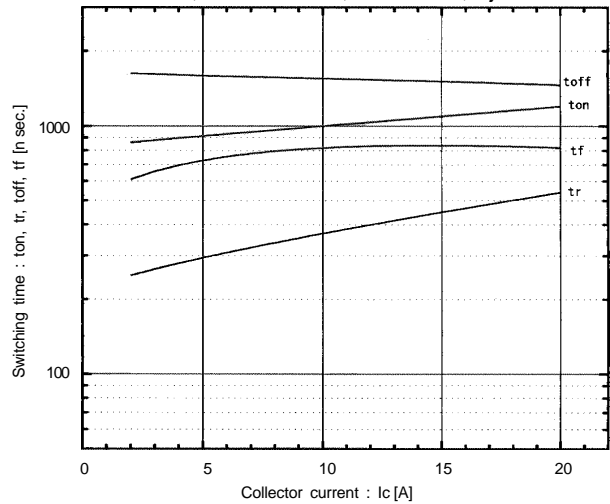

Characteristics

1MB10-120, 1MB10D-120

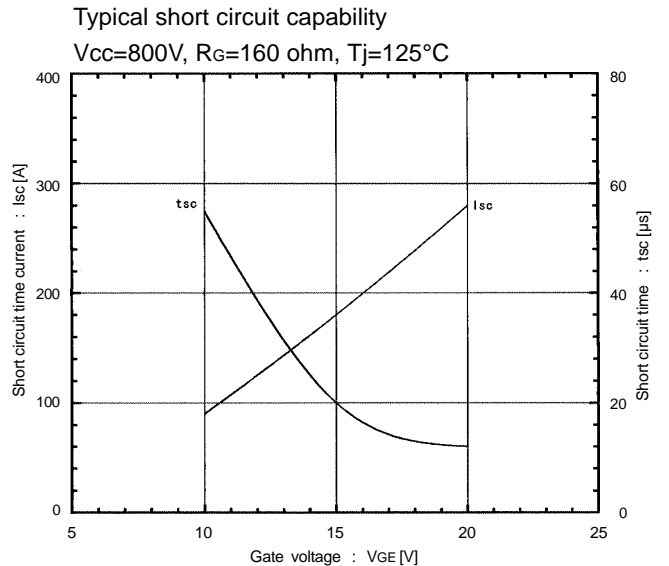
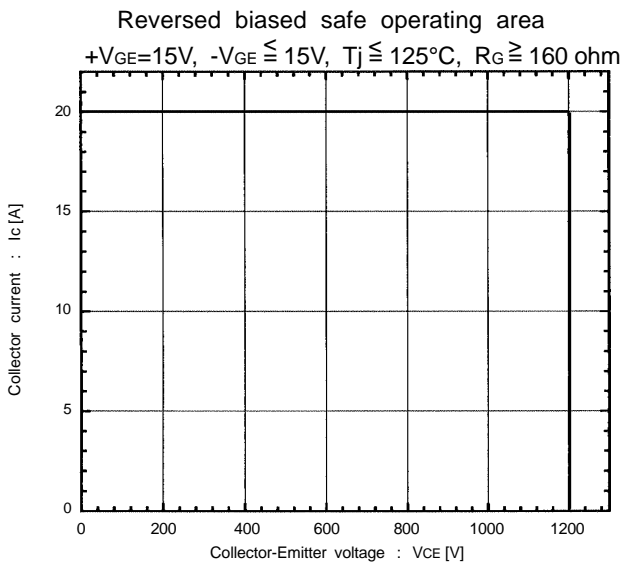
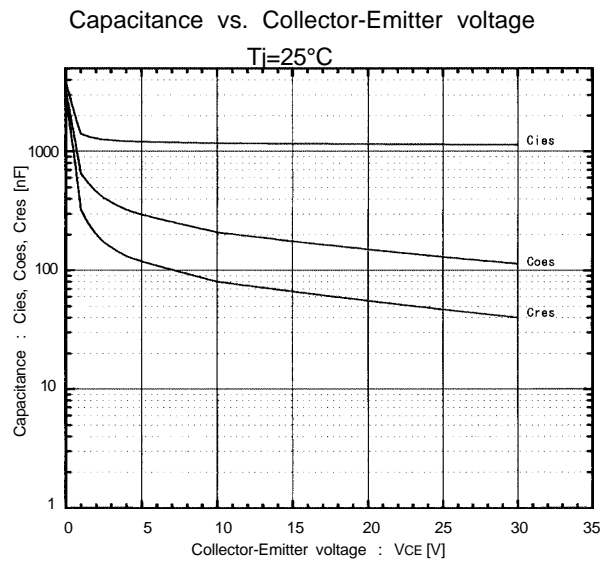
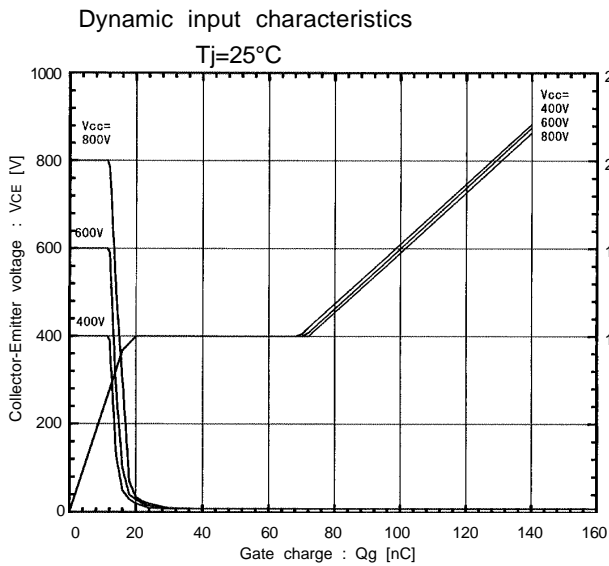
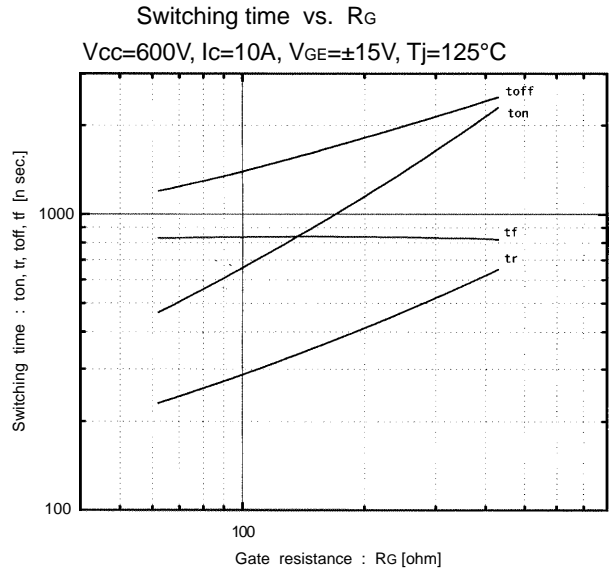
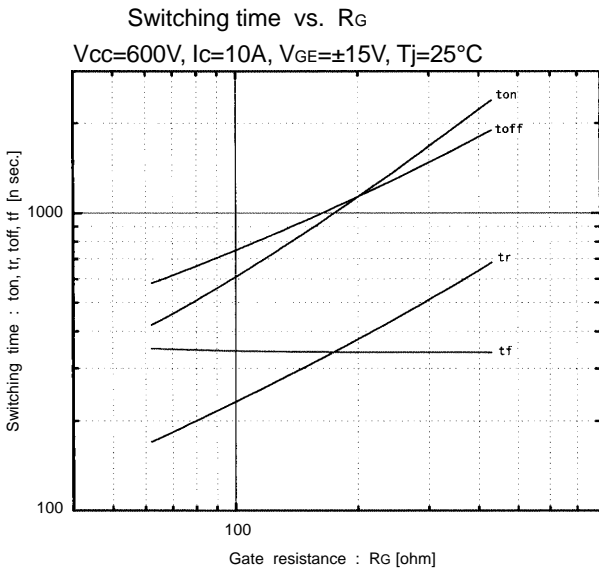

■ Characteristics

1MB10-120, 1MB10D-120

Transient thermal resistance

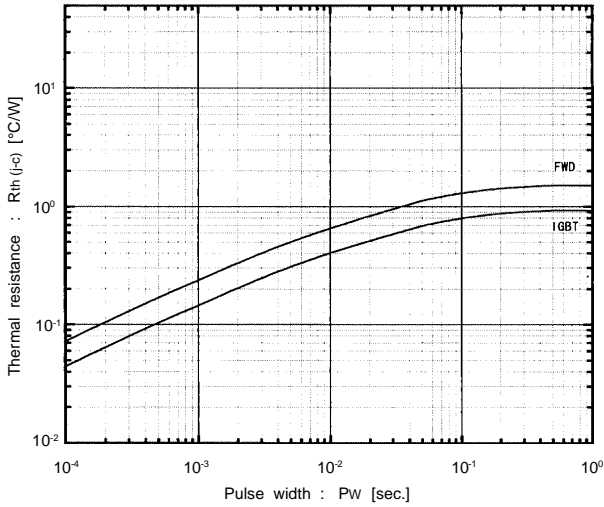

1MB10D-120

Reverse recovery time vs. Forward current

-di/dt=30A / μsec

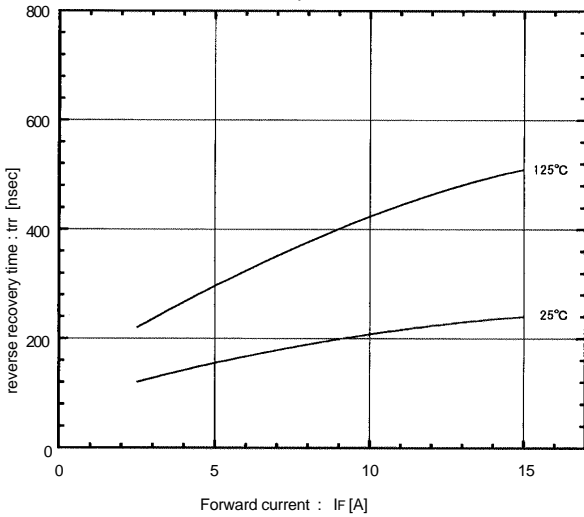

Reverse recovery current vs. Forward current

-di/dt=30A / μsec

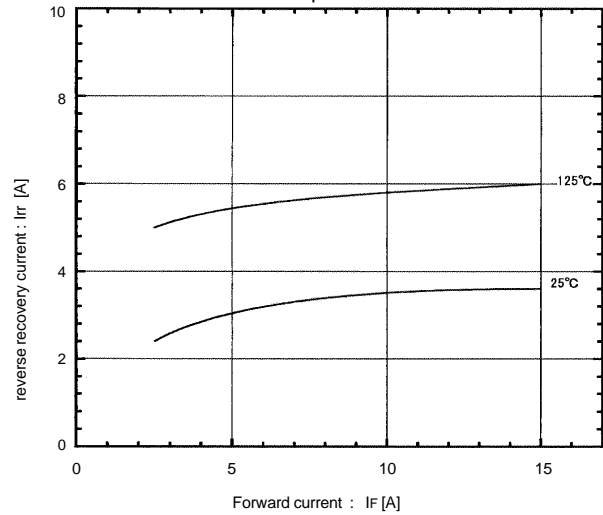

Forward current vs. Forward voltage

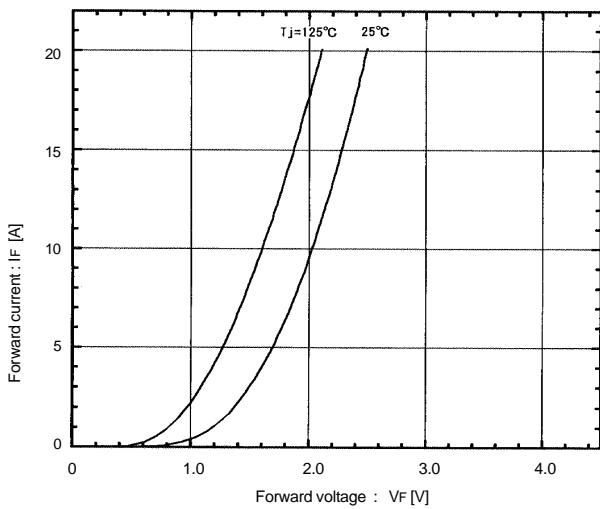

Reverse recovery time characteristics vs. -di/dt

IF=10A, Tj=125°C

