

# 1MBH08D-120

Molded IGBT

## 1200V / 8A Molded Package

### Outline drawings, mm TO-3PL

#### Features

- Small molded package
- Low power loss
- Soft switching with low switching surge and noise
- High reliability, high ruggedness (RBSOA, SCSOA etc.)
- Comprehensive line-up

#### Applications

- Inverter for Motor drive
- AC and DC Servo drive amplifier
- Uninterruptible power supply

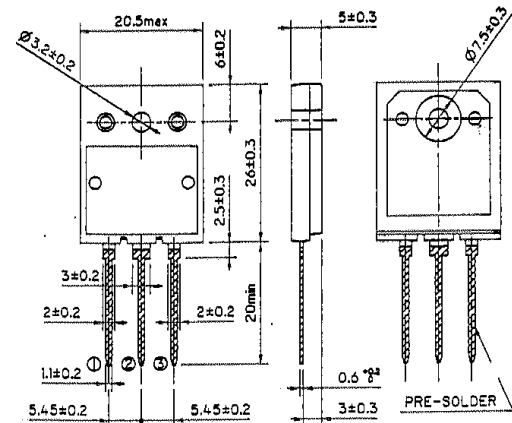

#### CONNECTION



#### Maximum ratings and characteristics

##### Absolute maximum ratings (Tc=25°C)

Item	Symbol	Rating	Unit		
Collector-Emitter voltage	V <sub>CES</sub>	1200	V		
Gate-Emitter voltage	V <sub>GES</sub>	±20	V		
Collector current	DC	T <sub>c</sub> =25°C	I <sub>c25</sub>	15	A
		T <sub>c</sub> =105°C	I <sub>c105</sub>	8	A
	1ms	T <sub>c</sub> =25°C	I <sub>cp</sub>	39	A
Max. power dissipation (IGBT)	P <sub>c</sub>	135	W		
Max. power dissipation (FWD)	P <sub>c</sub>	85	W		
Operating temperature	T <sub>j</sub>	+150	°C		
Storage temperature	T <sub>stg</sub>	-40 to +150	°C		
Screw torque	-	70	N·m		

#### Equivalent Circuit Schematic

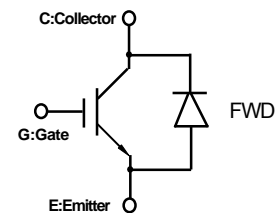

##### Electrical characteristics (at Tc=25°C unless otherwise specified)

Item	Symbol	Characteristics			Conditions	Unit	
		Min.	Typ.	Max.			
Zero gate voltage collector current	I <sub>CES</sub>	-	-	1.0	V <sub>GE</sub> =0V, V <sub>CE</sub> =1200V	mA	
Gate-Emitter leakage current	I <sub>GES</sub>	-	-	20	V <sub>CE</sub> =0V, V <sub>GE</sub> =±20V	µA	
Gate-Emitter threshold voltage	V <sub>GE(th)</sub>	5.5	-	8.5	V <sub>CE</sub> =20V, I <sub>c</sub> =8mA	V	
Collector-Emitter saturation voltage	V <sub>CE(sat)</sub>	-	-	3.5	V <sub>GE</sub> =15V, I <sub>c</sub> =8A	V	
Input capacitance	C <sub>ies</sub>	-	1000	-	V <sub>GE</sub> =0V	pF	
Output capacitance	C <sub>oes</sub>	-	160	-	V <sub>CE</sub> =10V		
Reverse transfer capacitance	C <sub>res</sub>	-	60	-	f=1MHz		
Switching Time	Turn-on time	t <sub>on</sub>	-	-	1.2	V <sub>CC</sub> =600V, I <sub>c</sub> =8A	µs
		t <sub>r</sub>	-	-	0.6	V <sub>GE</sub> =±15V	
	Turn-off time	t <sub>off</sub>	-	-	1.5	R <sub>G</sub> =200 ohm	(Half Bridge)
		t <sub>f</sub>	-	-	0.5		
	Turn-on time	t <sub>on</sub>	-	0.16	-	V <sub>CC</sub> =600V, I <sub>c</sub> =8A	µs
		t <sub>r</sub>	-	0.11	-	V <sub>GE</sub> =+15V	
Turn-off time	t <sub>off</sub>	-	0.30	-	R <sub>G</sub> =20 ohm	(Half Bridge)	
	t <sub>f</sub>	-	-	0.50			
FWD forward on voltage	V <sub>F</sub>	-	-	3.0	I <sub>F</sub> =8A	V	
Reverse recovery time	t <sub>rr</sub>	-	-	0.35	I <sub>F</sub> =8A, V <sub>GE</sub> =-10V, V <sub>R</sub> =200V, di/dt=100A/µs	µs	

##### Thermal resistance characteristics

Item	Symbol	Characteristics			Conditions	Unit
		Min.	Typ.	Max.		
Thermal resistance	R <sub>th(j-c)</sub>	-	-	0.92	IGBT	°C/W
	R <sub>th(j-c)</sub>	-	-	1.47	FWD	°C/W

Characteristics

Collector current vs. Collector-Emitter voltage  
Tj=25°C

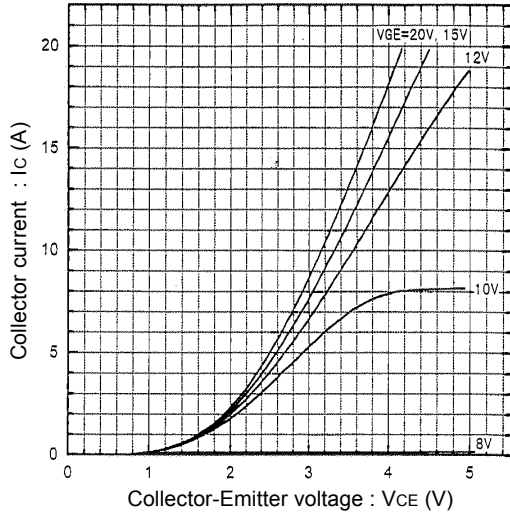

Collector current vs. Collector-Emitter voltage  
Tj=125°C

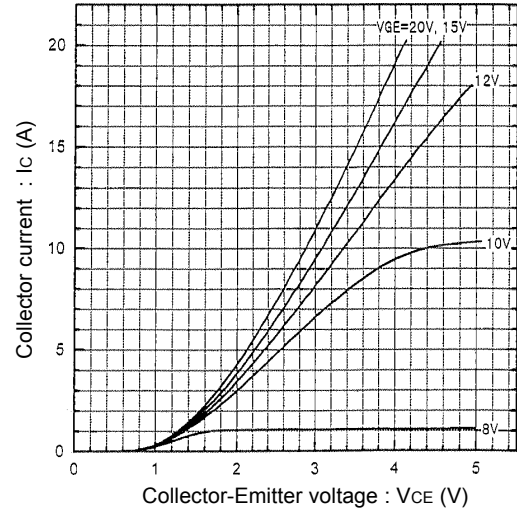

Collector-Emitter voltage vs. Gate-Emitter voltage  
Tj=25°C

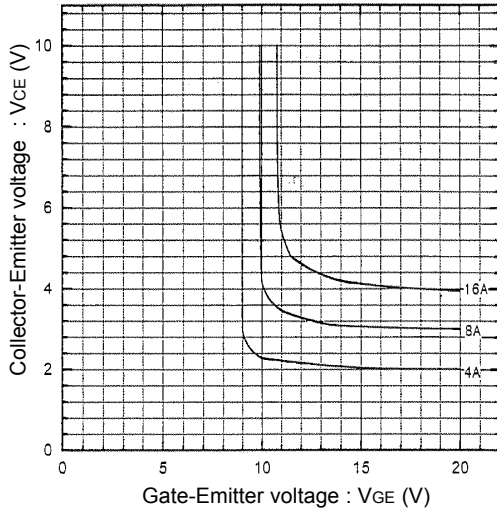

Collector-Emitter voltage vs. Gate-Emitter voltage  
Tj=125°C

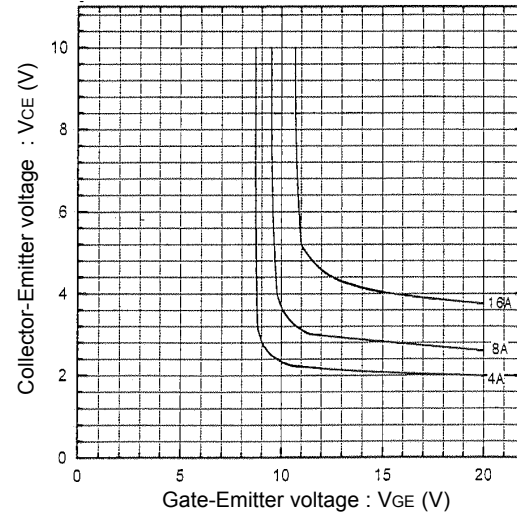

Switching time vs. Collector current  
VCC=600V, RG=20Ω, VGE=±15V, Tj=25°C

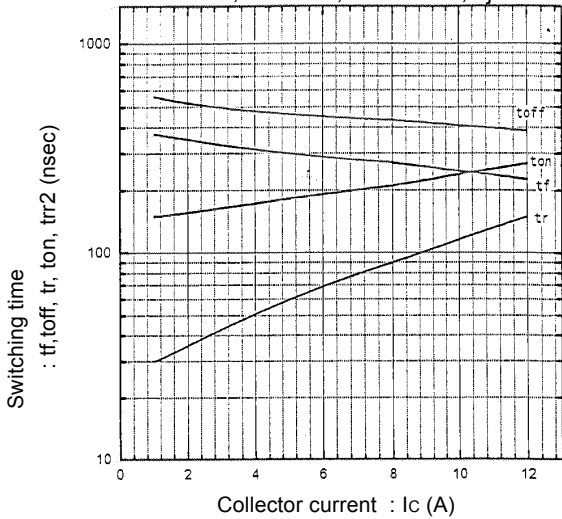

Switching time vs. Collector current  
VCC=600V, RG=20Ω, VGE=±15V, Tj=125°C

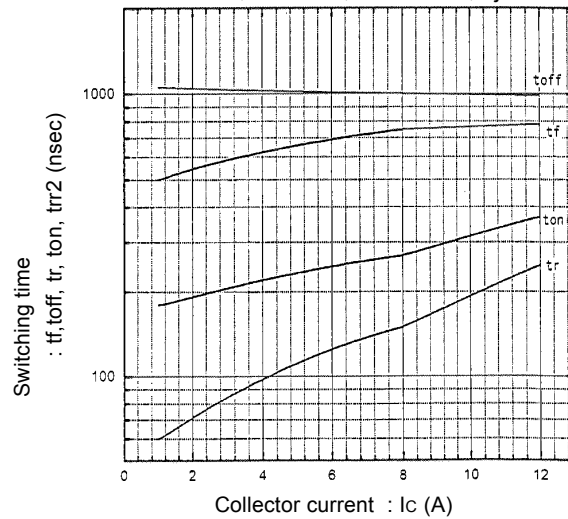

Characteristics

Switching time vs.  $R_G$   
 $V_{CC}=600V, I_C=8A, V_{GE}=\pm 15V, T_J=25^\circ C$

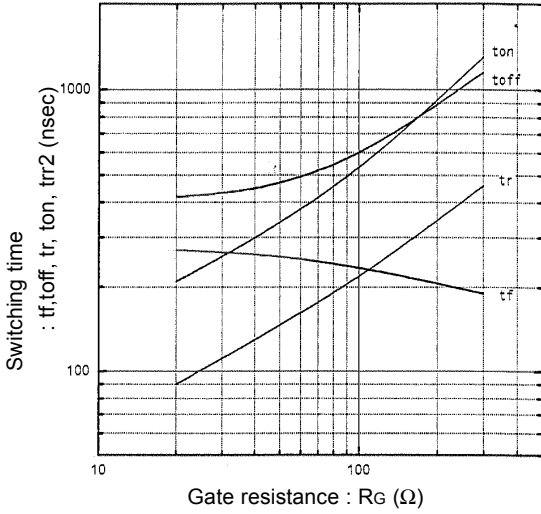

Switching time vs.  $R_G$   
 $V_{CC}=600V, I_C=8A, V_{GE}=\pm 15V, T_J=125^\circ C$

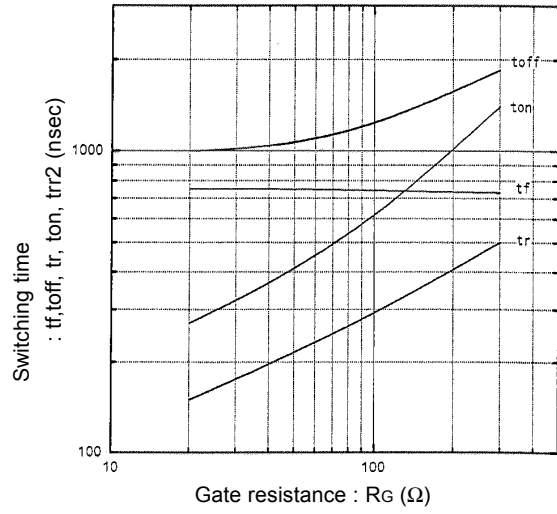

Dynamic input characteristics  
 $T_J=25^\circ C$

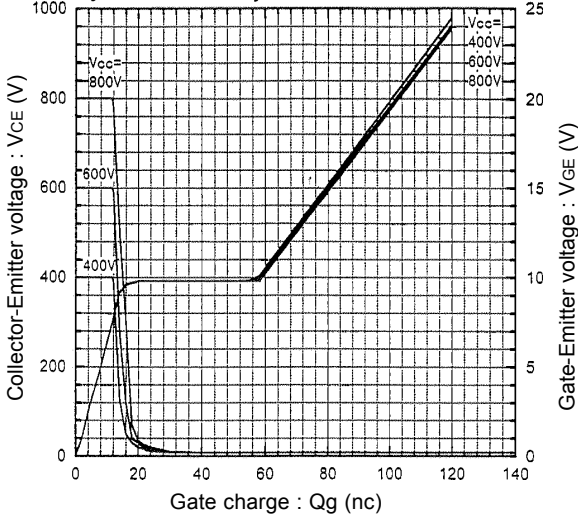

Capacitance vs. Collector-Emitter voltage  
 $T_J=25^\circ C$

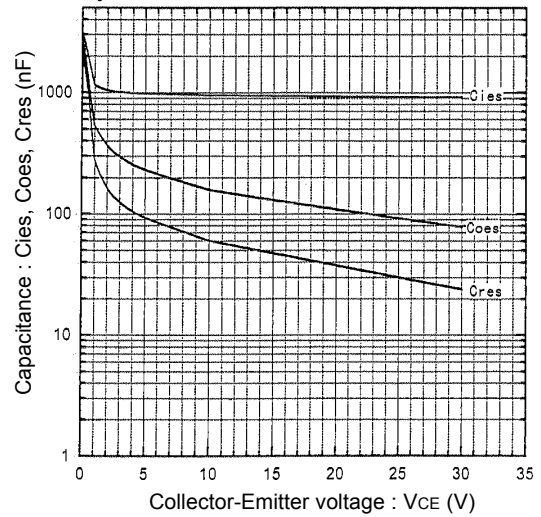

Reverse Biased Safe Operating Area  
 $+V_{GE}=15V, -V_{GE}\leq 15V, T_J\leq 125^\circ C, R_G\geq 20\Omega$

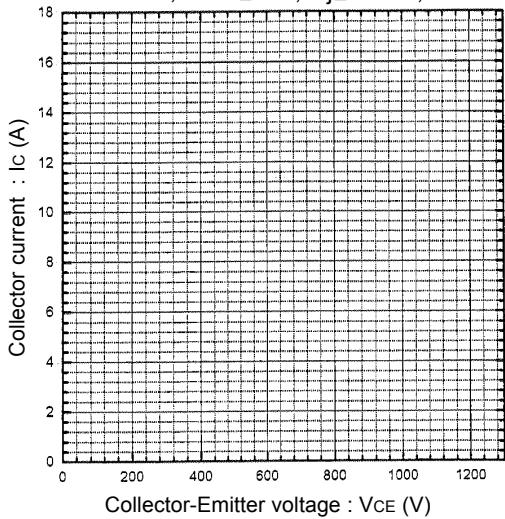

Typical short circuit capability  
 $V_{CC}=800V, R_G=20\Omega, T_J=125^\circ C,$

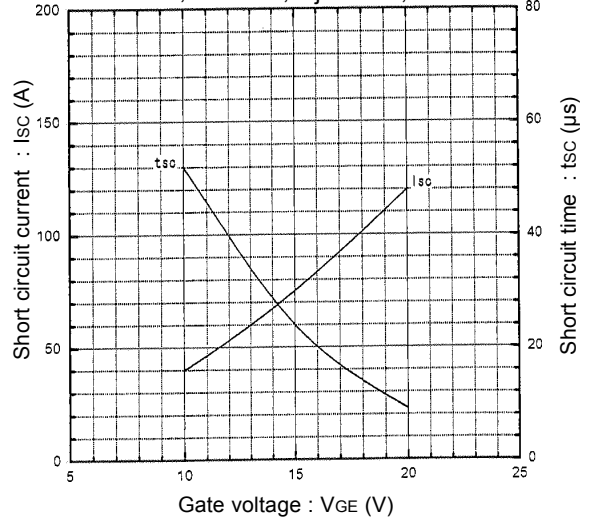

■ Characteristics

Reverse recovery time vs. Forward current  
VR=200V, -di/dt=100A/μsec

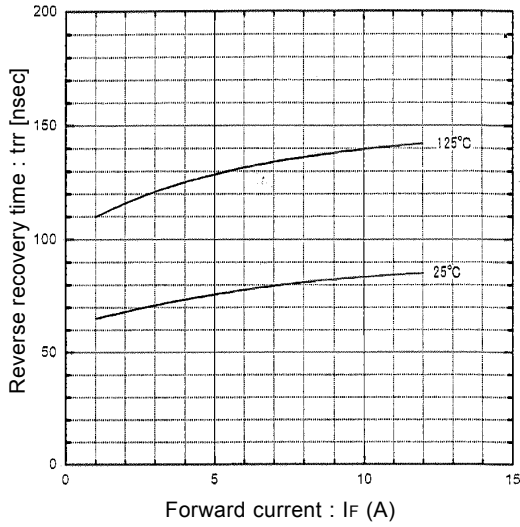

Reverse recovery current vs. Forward current  
VR=200V, -di/dt=100A/μsec

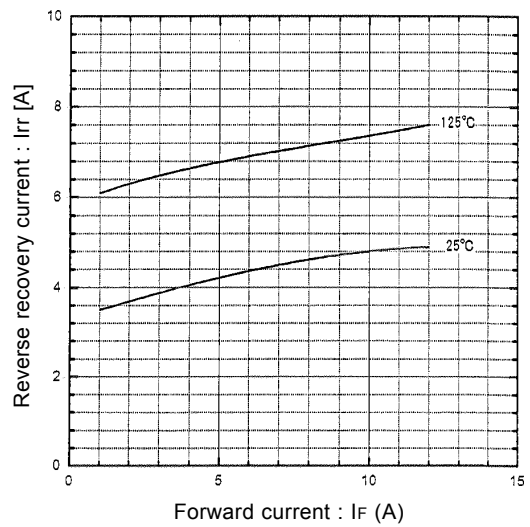

Forward Voltage vs. Forward current

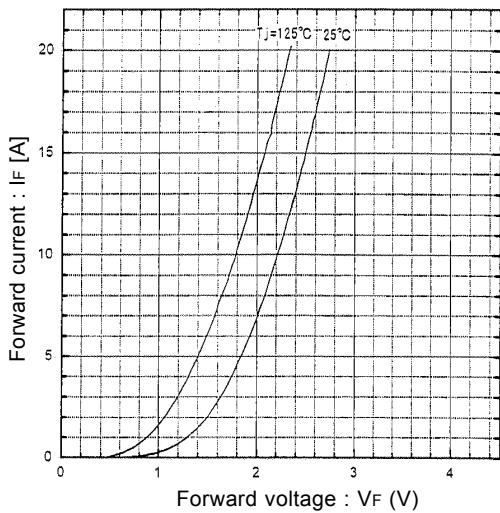

Reverse recovery characteristics vs. -di/dt  
IF=8A, Tj=125°C

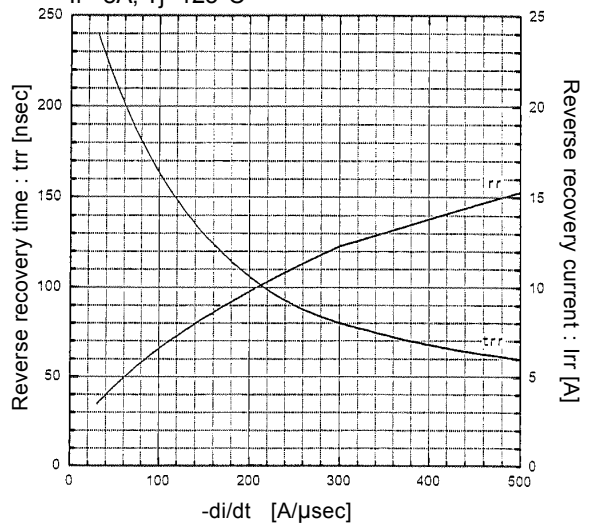

Transient thermal resistance

