

# 1MBH75D-060S

Molded IGBT

## 600V / 75A Molded Package

### ■ Features

- Small molded package
- Low power loss
- Soft switching with low switching surge and noise
- High reliability, high ruggedness (RBSOA, SCSOA etc.)
- Comprehensive line-up

### ■ Applications

- Inverter for Motor drive
- AC and DC Servo drive amplifier
- Uninterruptible power supply

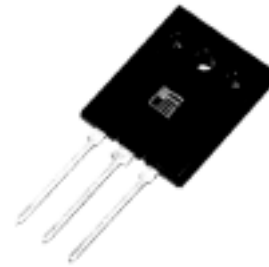

### ■ Maximum ratings and characteristics

#### ● Absolute maximum ratings (Tc=25°C)

Item	Symbol	Rating	Unit		
Collector-Emitter voltage	V <sub>CES</sub>	600	V		
Gate-Emitter voltage	V <sub>GES</sub>	±20	V		
Collector current	DC	T <sub>c</sub> =25°C	I <sub>C25</sub>	83	A
		T <sub>c</sub> =100°C	I <sub>C100</sub>	75	A
	1ms	T <sub>c</sub> =25°C	I <sub>CP</sub>	225	A
Max. power dissipation (IGBT)	P <sub>C</sub>	310	W		
Max. power dissipation (FWD)	P <sub>C</sub>	180	W		
Operating temperature	T <sub>j</sub>	+150	°C		
Storage temperature	T <sub>stg</sub>	-40 to +150	°C		
Screw torque	-	58.8 to 78.4	N·cm		

### ■ Equivalent Circuit Schematic

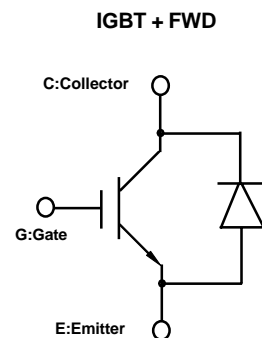

#### ● Electrical characteristics (at Tc=25°C unless otherwise specified)

Item	Symbol	Characteristics			Conditions	Unit	
		Min.	Typ.	Max.			
Zero gate voltage collector current	I <sub>CES</sub>	-	-	1.0	V <sub>GE</sub> =0V, V <sub>CES</sub> =600V	mA	
Gate-Emitter leakage current	I <sub>GES</sub>	-	-	10	V <sub>CE</sub> =0V, V <sub>GE</sub> =±20V	µA	
Gate-Emitter threshold voltage	V <sub>GE(th)</sub>	4.0	5.0	6.0	V <sub>CE</sub> =20V, I <sub>C</sub> =75mA	V	
Collector-Emitter saturation voltage	V <sub>CE(sat)</sub>	-	2.4	2.9	V <sub>GE</sub> =15V, I <sub>C</sub> =75A	V	
Input capacitance	C <sub>ies</sub>	-	3700	-	V <sub>GE</sub> =0V	pF	
Output capacitance	C <sub>oes</sub>	-	350	-	V <sub>CE</sub> =25V		
Reverse transfer capacitance	C <sub>res</sub>	-	190	-	f=1MHz		
Switching Time	Turn-on time	t <sub>on</sub> *	-	0.15	-	V <sub>CC</sub> =300V, I <sub>C</sub> =75A	µs
		t <sub>r</sub> *	-	0.09	-	V <sub>GE</sub> =±15V	
		t <sub>rr2</sub>	-	0.03	-	R <sub>G</sub> =24 ohm	
	Turn-off time	t <sub>off</sub>	-	0.50	0.62	(Half Bridge)	µs
		t <sub>f</sub>	-	0.10	0.17	Inductance Load	
		t <sub>rr</sub>	-	0.10	0.17		
	Turn-on time	t <sub>on</sub> *	-	0.15	-	V <sub>CC</sub> =300V, I <sub>C</sub> =75A	µs
		t <sub>r</sub> *	-	0.09	-	V <sub>GE</sub> =+15V	
t <sub>rr2</sub>		-	0.03	-	R <sub>G</sub> =6 ohm		
Turn-off time	t <sub>off</sub>	-	0.50	0.62	(Half Bridge)	µs	
	t <sub>f</sub>	-	0.10	0.17	Inductance Load		
	t <sub>rr</sub>	-	0.10	0.17			
FWD forward on voltage	V <sub>F</sub>	-	2.0	2.5	I <sub>F</sub> =75A, V <sub>GE</sub> =0V	V	
Reverse recovery time	t <sub>rr</sub>	-	0.06	0.10	I <sub>F</sub> =75A, V <sub>GE</sub> =-10V, V <sub>R</sub> =300V, di/dt=100A/µs	µs	

\*Turn-on characteristics include t<sub>rr2</sub>. See a figure in next page.

#### ● Thermal resistance characteristics

Item	Symbol	Characteristics			Conditions	Unit
		Min.	Typ.	Max.		
Thermal resistance	R <sub>th(j-c)</sub>	-	-	0.40	IGBT	°C/W
	R <sub>th(j-c)</sub>	-	-	0.69	FWD	°C/W

Outline drawings, mm

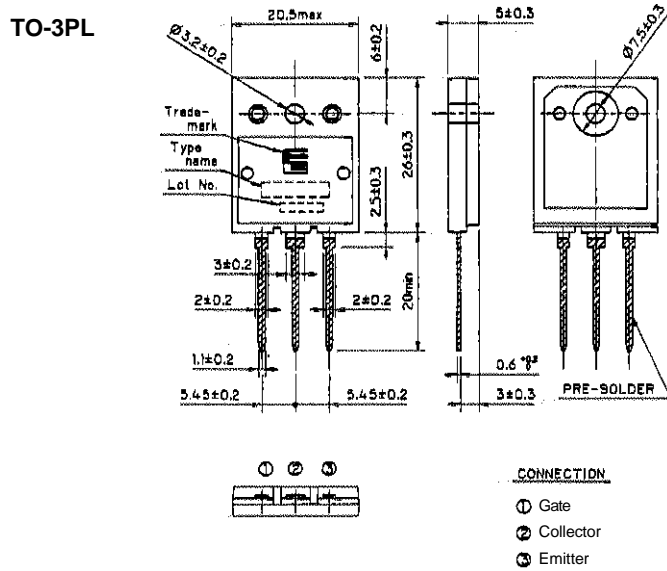

Switching waveform (Inductance load)

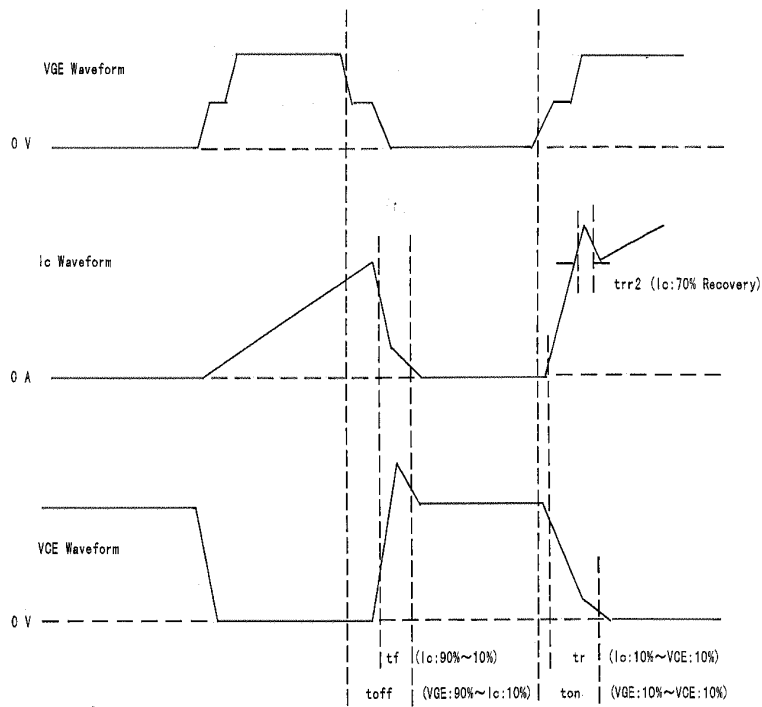

Measurement circuit

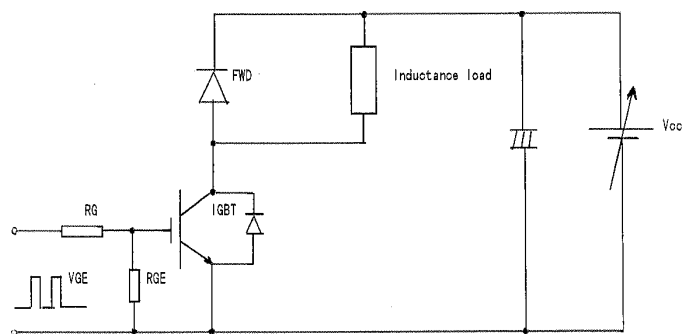

Characteristics

Collector current vs. Collector-Emitter voltage  
T<sub>j</sub>=25°C

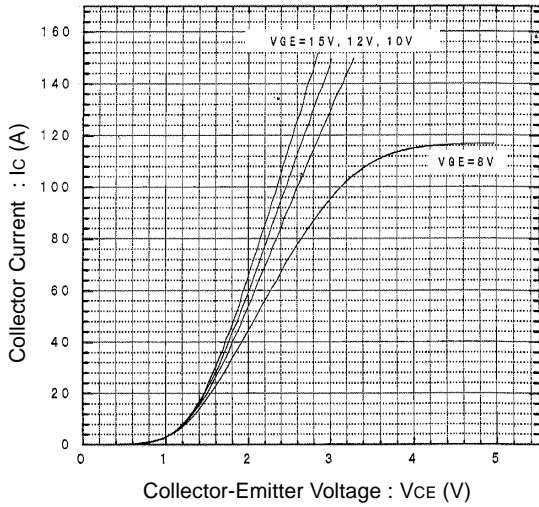

Collector current vs. Collector-Emitter voltage  
T<sub>j</sub>=125°C

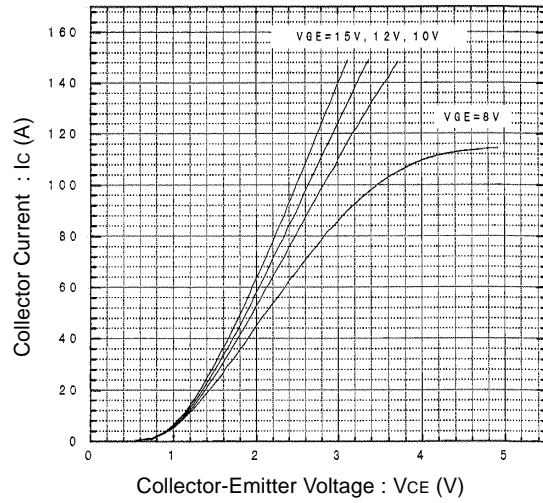

Collector-Emitter voltage vs. Gate-Emitter voltage  
T<sub>j</sub>=25°C

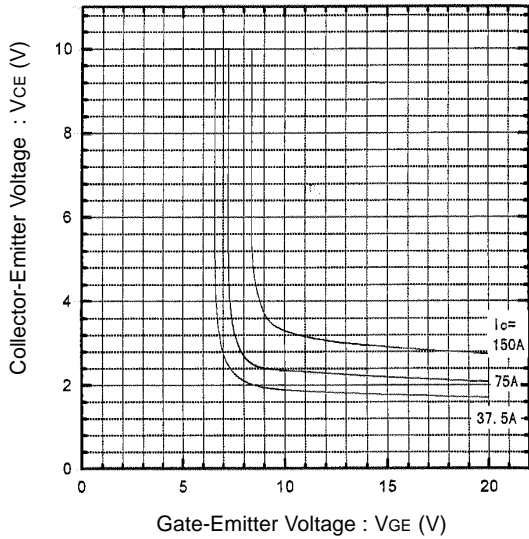

Collector-Emitter voltage vs. Gate-Emitter voltage  
T<sub>j</sub>=125°C

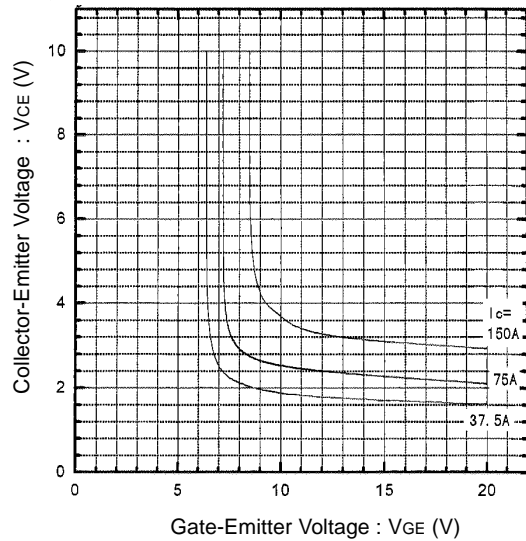

Switching time vs. Collector current  
V<sub>CC</sub>=300V, R<sub>G</sub>=6Ω, V<sub>GE</sub>=+15V, T<sub>j</sub>=125°C

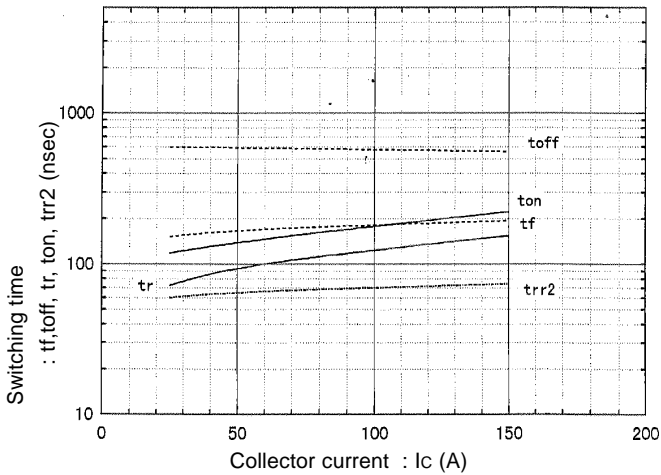

Switching time vs. Collector current  
V<sub>CC</sub>=300V, R<sub>G</sub>=24Ω, V<sub>GE</sub>=±15V, T<sub>j</sub>=125°C

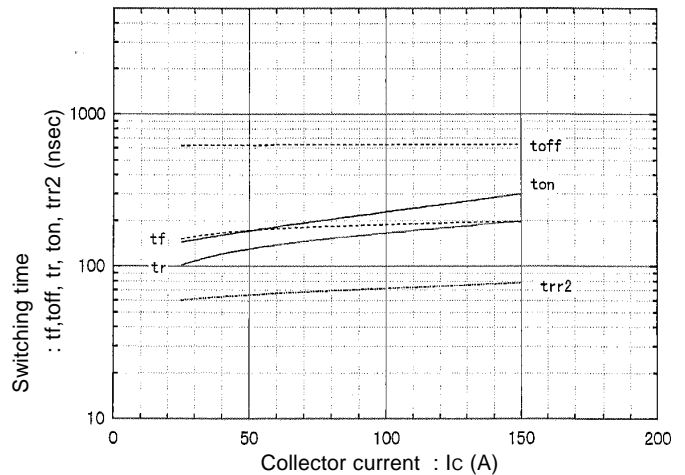

Characteristics

Switching time vs. R<sub>G</sub>

V<sub>CC</sub>=300V, I<sub>C</sub>=75A, V<sub>GE</sub>=+15V, T<sub>J</sub>=125°C

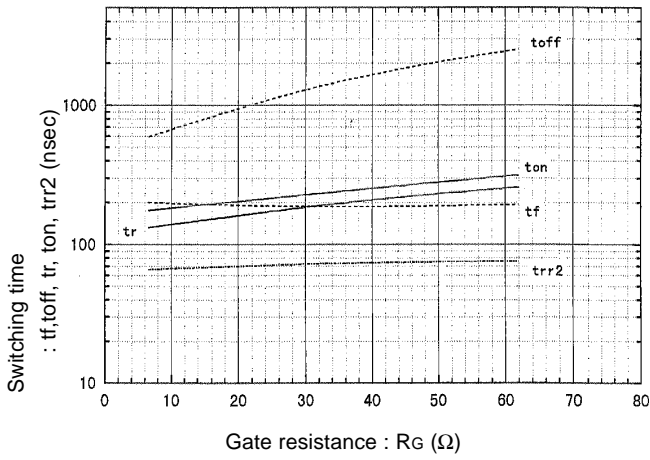

Switching time vs. R<sub>G</sub>

V<sub>CC</sub>=300V, I<sub>C</sub>=75A, V<sub>GE</sub>=±15V, T<sub>J</sub>=125°C

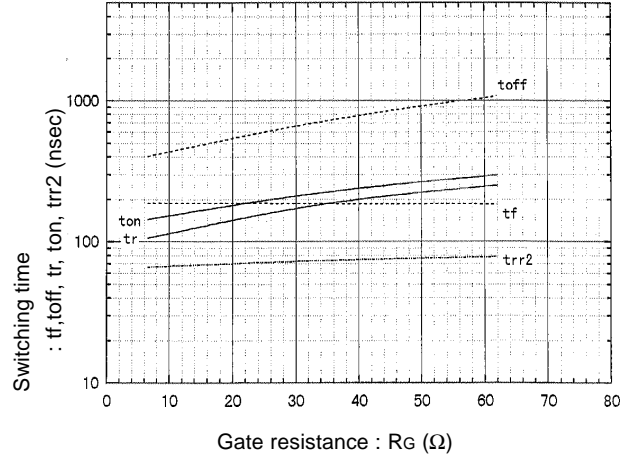

Dynamic input characteristics

T<sub>J</sub>=25°C

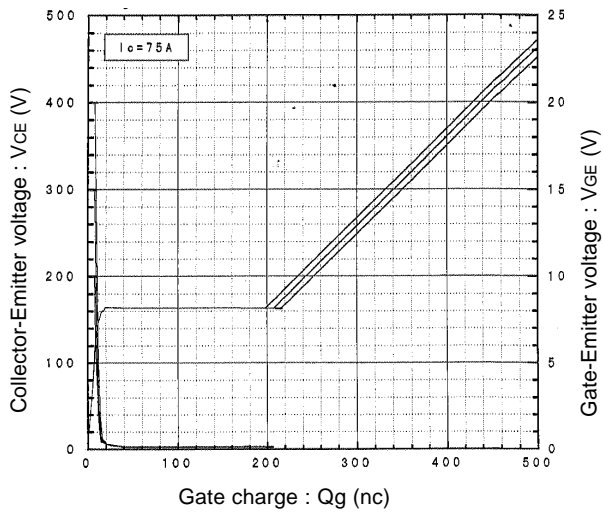

Capacitance vs. Collector-Emitter voltage

T<sub>J</sub>=25°C

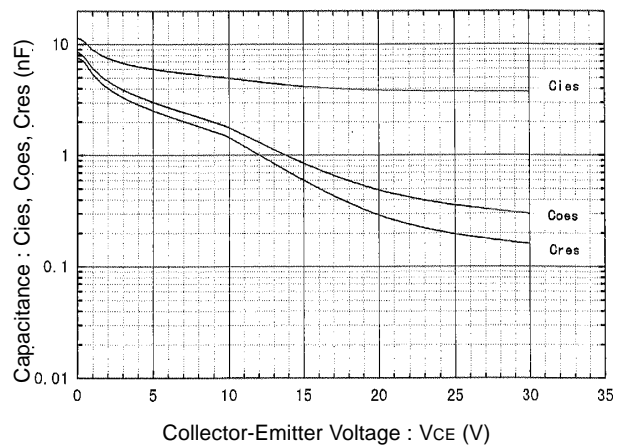

Reverse Biased Safe Operating Area

R<sub>G</sub>=6Ω, +V<sub>GE</sub> ≤ 20V, -V<sub>GE</sub>=15V, T<sub>J</sub> ≤ 125°C

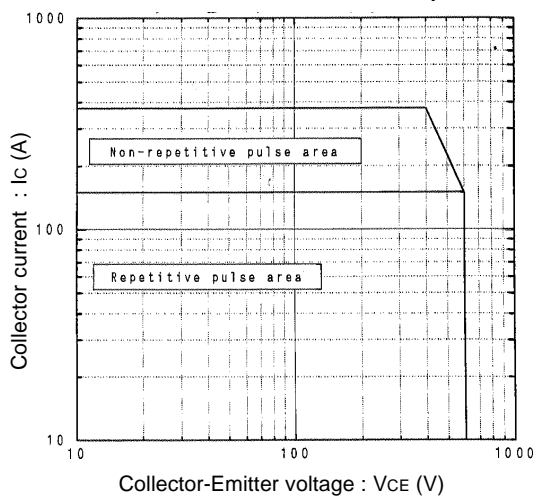

Forward Bias Safe Operating Area

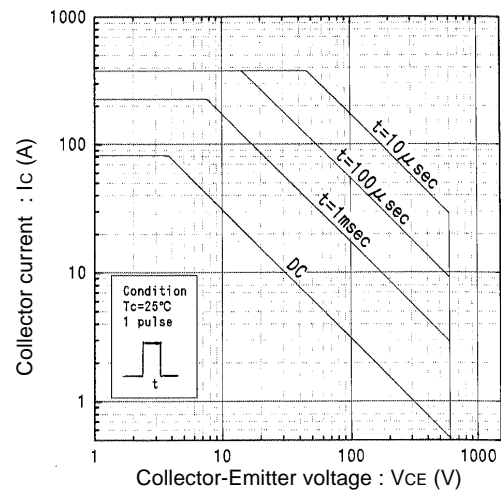

■ Characteristics

