

# 1MBI150NK-060

IGBT Module

## 600V / 150A Chopper Module

### ■ Features

- High speed switching
- Low inductance module structure
- Suitable for Chopper circuit

### ■ Applications

- Uninterruptible power supply
- Inverter for Motor drive



### ■ Maximum ratings and characteristics

#### ● Absolute maximum ratings (at Tc=25°C unless otherwise specified)

Item	Symbol	Rating	Unit		
IGBT	Collector-Emitter voltage	V <sub>CES</sub>	600	V	
	Gate-Emitter voltage	V <sub>GES</sub>	±20	V	
	Collector current	Continuous	I <sub>C</sub>	150	A
		1 ms	I <sub>C</sub> pulse	300	A
	Max. power dissipation	P <sub>C</sub>	600	W	
FWD	Repetitive peak dissipation	V <sub>RRM</sub>	600	V	
	Forward current	I <sub>F</sub>	150	A	
		1 ms	I <sub>F</sub> pulse	300	A
Operating temperature	T <sub>j</sub>	+150	°C		
Storage temperature	T <sub>stg</sub>	-40 to +125	°C		
Isolation voltage	V <sub>is</sub>	AC 2500 (1min.)	V		
Screw torque	Mounting *1	3.5	N·m		
	Terminals *1	3.5	N·m		

\*1 : Recommendable value : 2.5 to 3.5 N·m (M5)

### ■ Equivalent Circuit Schematic

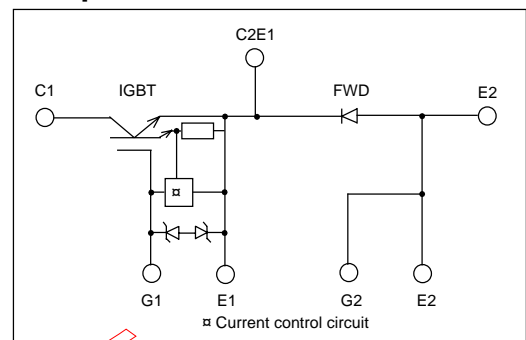

#### ● Electrical characteristics (at Tj=25°C unless otherwise specified)

Item	Symbol	Characteristics			Conditions	Unit	
		Min.	Typ.	Max.			
IGBT	Zero gate voltage collector current	I <sub>CES</sub>	–	–	1.0	V <sub>GE</sub> =0V, V <sub>C</sub> E=600V	mA
	Gate-Emitter leakage current	I <sub>GES</sub>	–	–	15	V <sub>C</sub> E=0V, V <sub>GE</sub> =±20V	μA
	Gate-Emitter threshold voltage	V <sub>GE(th)</sub>	4.5	–	7.5	V <sub>C</sub> E=20V, I <sub>C</sub> =150mA	V
	Collector-Emitter saturation voltage	V <sub>C(sat)</sub>	–	–	2.8	V <sub>GE</sub> =15V, I <sub>C</sub> =150A	V
	Input capacitance	C <sub>ies</sub>	–	9900	–	V <sub>GE</sub> =0V	pF
	Output capacitance	C <sub>oes</sub>	–	2200	–	V <sub>C</sub> E=10V	
	Reverse transfer capacitance	C <sub>res</sub>	–	1000	–	f=1MHz	
	Turn-on time	t <sub>on</sub>	–	0.6	1.2	V <sub>CC</sub> =300V	μs
			–	0.2	0.6	I <sub>C</sub> =150A	
		Turn-off time	t <sub>off</sub>	–	0.6	1.0	
t <sub>f</sub>			–	0.2	0.35	R <sub>G</sub> =16ohm	
FWD	Diode forward on voltage	V <sub>F</sub>	–	–	3.0	I <sub>F</sub> =150A, V <sub>GE</sub> =0V	V
	Reverse recovery time	t <sub>rr</sub>	–	–	0.3	I <sub>F</sub> =150A	μs
	Reverse current	I <sub>RRM</sub>	–	–	1.0	V <sub>R</sub> =600V	mA

#### ● Thermal resistance characteristics

Item	Symbol	Characteristics			Conditions	Unit
		Min.	Typ.	Max.		
Thermal resistance	R <sub>th(j-c)</sub>	–	–	0.21	IGBT	°C/W
	R <sub>th(j-c)</sub>	–	–	0.47	FWD	°C/W
	R <sub>th(c-f)*2</sub>	–	0.05	–	the base to cooling fin	°C/W

\*2 : This is the value which is defined mounting on the additional cooling fin with thermal compound

■ Characteristics (Representative)

Collector current vs. Collector-Emitter voltage  
T<sub>J</sub>=25°C

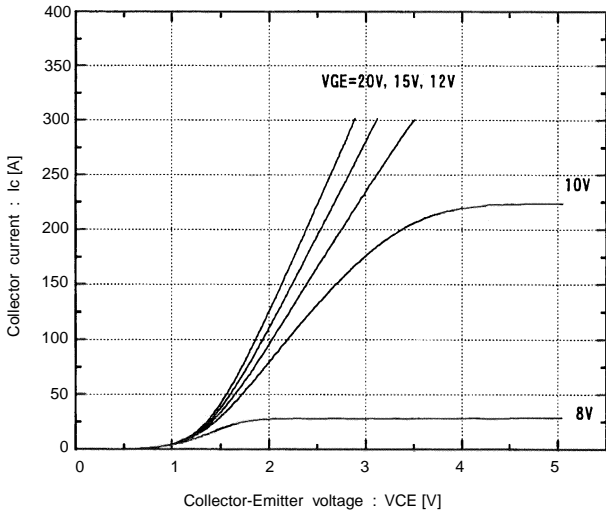

Collector current vs. Collector-Emitter voltage  
T<sub>J</sub>=125°C

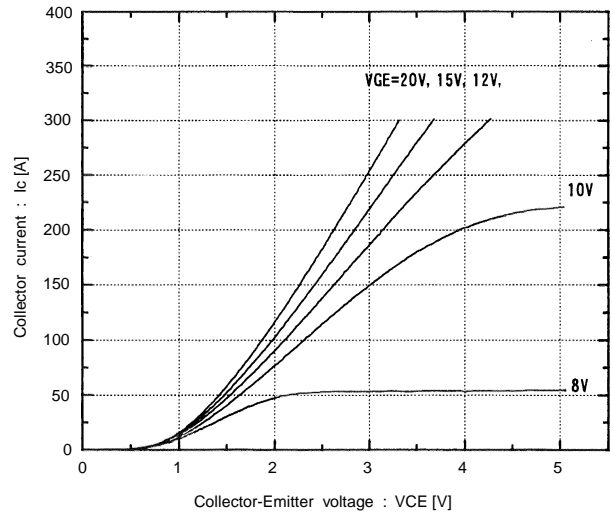

Collector-Emitter vs. Gate-Emitter voltage  
T<sub>J</sub>=25°C

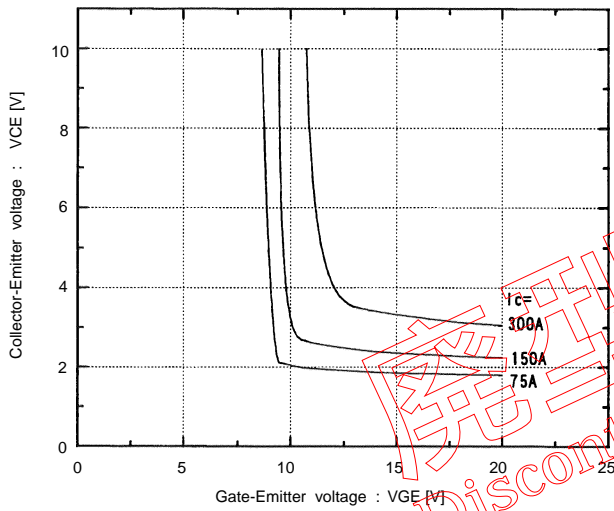

Collector-Emitter vs. Gate-Emitter voltage  
T<sub>J</sub>=125°C

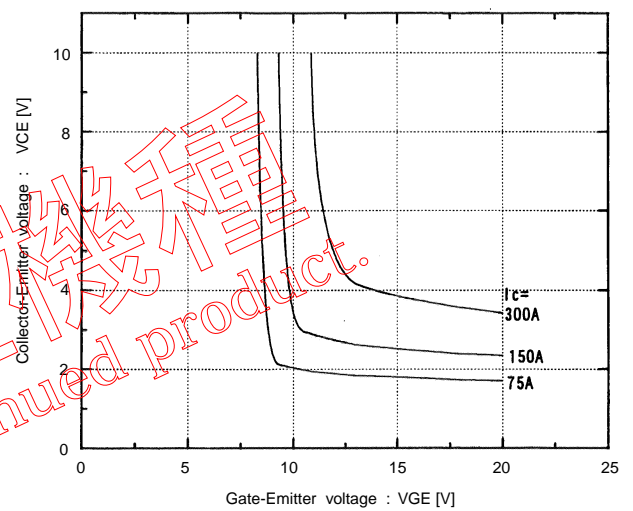

Switching time vs. Collector current  
V<sub>CC</sub>=300V, R<sub>G</sub>=16 ohm, V<sub>GE</sub>=±15V, T<sub>J</sub>=25°C

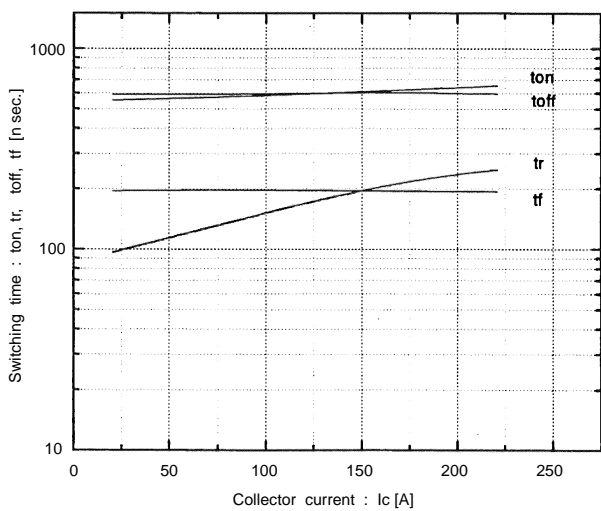

Switching time vs. Collector current  
V<sub>CC</sub>=300V, R<sub>G</sub>=16 ohm, V<sub>GE</sub>=±15V, T<sub>J</sub>=125°C

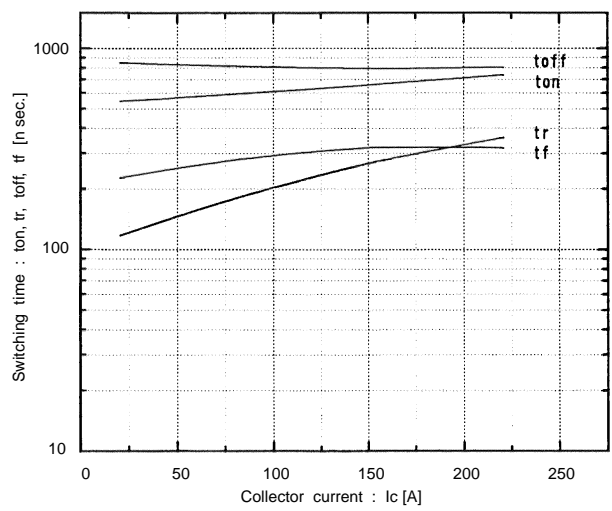

Switching time vs. RG  
 $V_{cc}=300V, I_c=150A, V_{GE}=\pm 15V, T_j=25^\circ C$

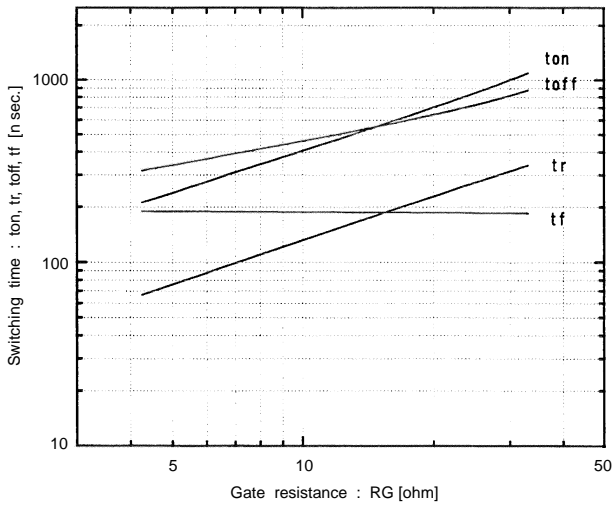

Dynamic input characteristics  
 $T_j=25^\circ C$

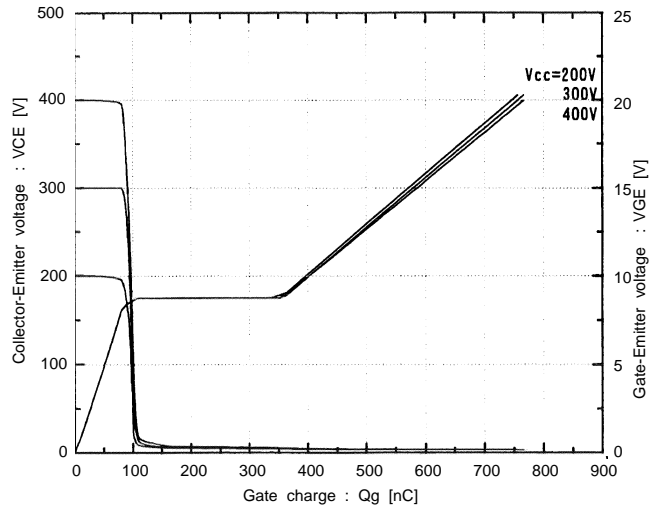

Forward current vs. Forward voltage  
 $V_{GE}=0V$

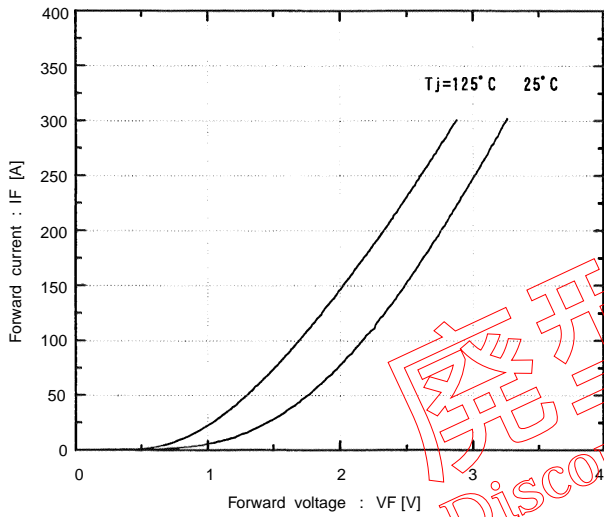

Reverse recovery characteristics  
 $t_{rr}, I_{rr}$  vs.  $I_F$

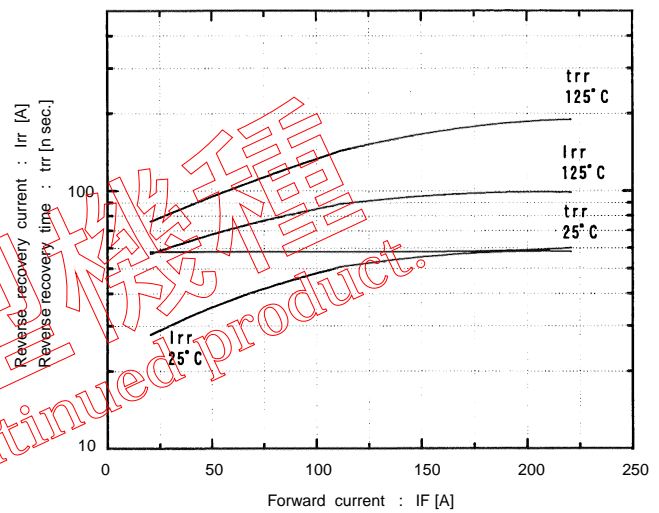

Transient thermal resistance

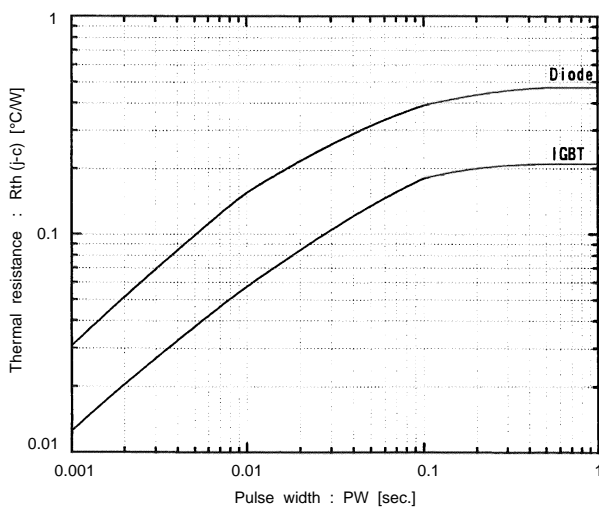

Reversed biased safe operating area  
 $+V_{GE}=\pm 15V, -V_{GE} \le 15V, T_j \le 125^\circ C, R_G \ge 16 \text{ ohm}$

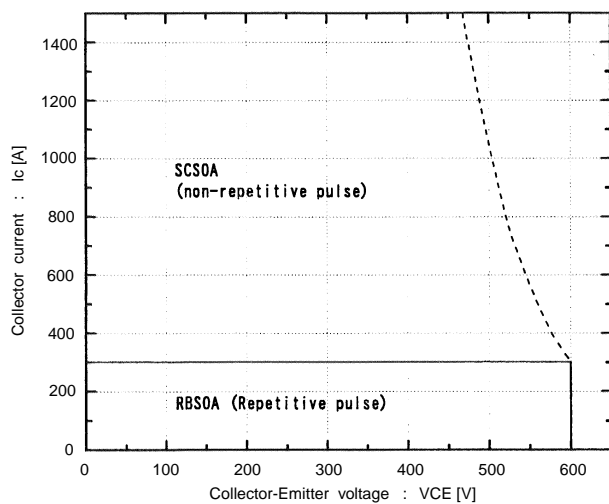

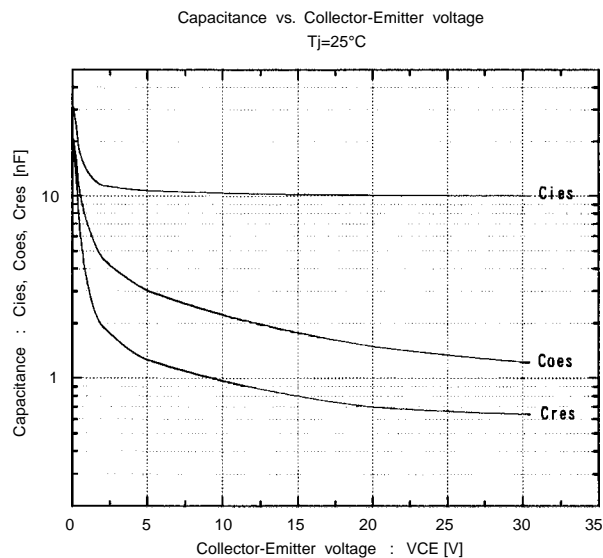
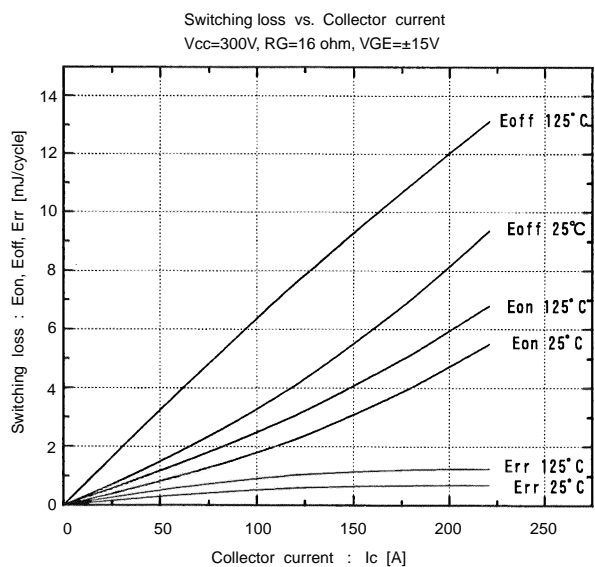

■ Outline Drawings, mm

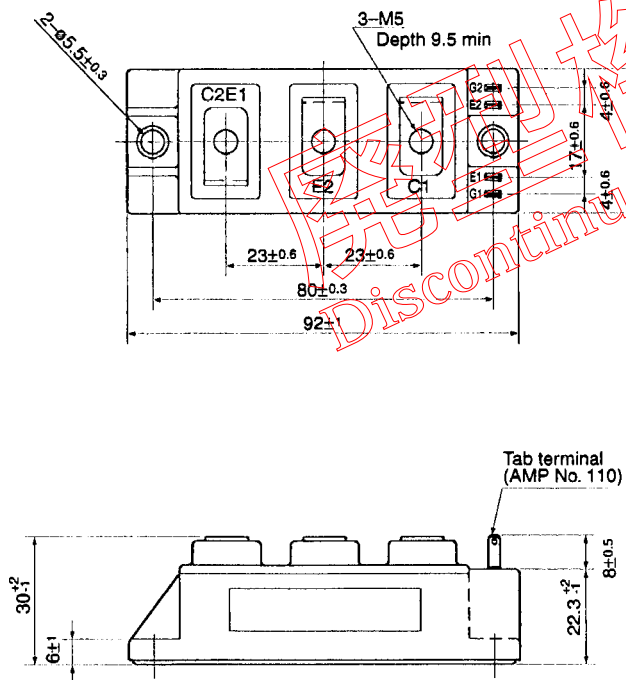

Mass : 180g