

## IGBT MODULE ( L series)

### ■ Features

- High Speed Switching
- Low Saturation Voltage
- Voltage Drive

### ■ Applications

- Inverter for Motor Drive
- AC and DC Servo Drive Amplifier
- Uninterruptible Power Supply
- Industrial Machines, such as Welding Machines

### ■ Maximum Ratings and Characteristics

#### ● Absolute Maximum Ratings

Items	Symbols	Ratings	Units
Collector-Emitter Voltage	V <sub>CES</sub>	1200	V
Gate-Emitter Voltage	V <sub>GES</sub>	±20	V
Collector Current	Continuous	I <sub>C</sub>	300
	1ms	I <sub>C pulse</sub>	600
	Continuous	-I <sub>C</sub>	300
	1ms	-I <sub>C pulse</sub>	600
Max. Power Dissipation	P <sub>C</sub>	2000	W
Operating Temperature	T <sub>j</sub>	+150	°C
Storage Temperature	T <sub>stg</sub>	-40 to +125	°C
Net. Weight		415	g
Isolation Voltage	AC. 1min.	V <sub>isol</sub>	2500 V
Screw Torque	Mounting *1	35	kg•cm
	Terminals *2	45	
	Terminals *3	17	

#### ● Electrical Characteristics (T<sub>c</sub>=25°C)

Items	Symbols	Test Conditions	Min.	Typ.	Max.	Units
Zero Gate Voltage Collector Current	I <sub>CES</sub>	V <sub>GE</sub> =0V V <sub>CES</sub> =1200V T <sub>c</sub> =25°C			4.0	mA
		V <sub>GE</sub> =0V V <sub>CES</sub> =1200V T <sub>c</sub> =125°C			—	mA
Gate-Emitter Leakage Current	I <sub>GES</sub>	V <sub>CES</sub> =0V V <sub>GE</sub> =±20V			400	nA
Gate-Emitter Threshold Voltage	V <sub>GE(th)</sub>	V <sub>CES</sub> =20V I <sub>C</sub> =300mA	3.0		6.0	V
Collector-Emitter Saturation Voltage	V <sub>CE(sat)</sub>	V <sub>GE</sub> =15V I <sub>C</sub> =300A			3.5	V
Input Capacitance	C <sub>ies</sub>	V <sub>GE</sub> =0V		54000		pF
Output Capacitance	C <sub>oes</sub>	V <sub>CES</sub> =10V		—		
Reverse Transfer Capacitance	C <sub>res</sub>	f=1MHz		—		
Turn-on Time	t <sub>on</sub>	V <sub>CC</sub> =600V		0.6	0.8	μs
	t <sub>r</sub>	I <sub>C</sub> =300A		0.4	0.6	
Turn-off Time	t <sub>off</sub>	V <sub>GE</sub> =±15V		0.8	1.5	
	t <sub>f</sub>	R <sub>G</sub> =2.7Ω		0.3	0.5	
Diode Forward On-Voltage	V <sub>F</sub>	I <sub>F</sub> =300A V <sub>GE</sub> =0V			2.5	V
Reverse Recovery Time	t <sub>rr</sub>	I <sub>F</sub> =300A -di/dt=900A/μs V <sub>GE</sub> =-10V		200	350	ns

#### ● Thermal Characteristics

Items	Symbols	Test Conditions	Min.	Typ.	Max.	Units
Thermal Resistance	R <sub>th(j-c)</sub>	IGBT			0.063	°C/W
	R <sub>th(j-e)</sub>	Diode			0.10	
	R <sub>th(c-f)</sub>	With Thermal compound		0.0125		

### ■ Outline Drawings

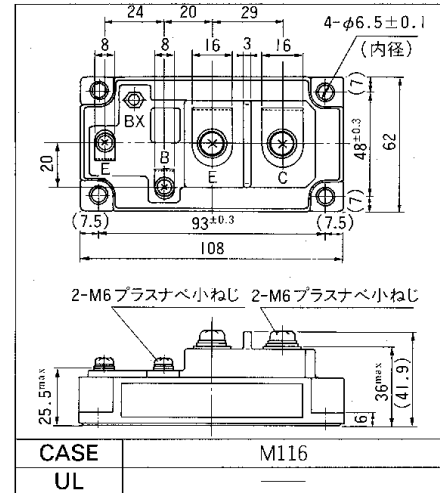

### ■ Equilavent Circuit Schematic

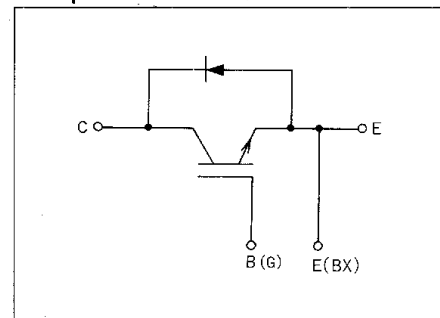

\*1 Recommendable Value 25 to 35kg•cm (M5)

\*2 Recommendable Value 35 to 45kg•cm (M6)

\*3 Recommendable Value 13 to 17kg•cm (M4)

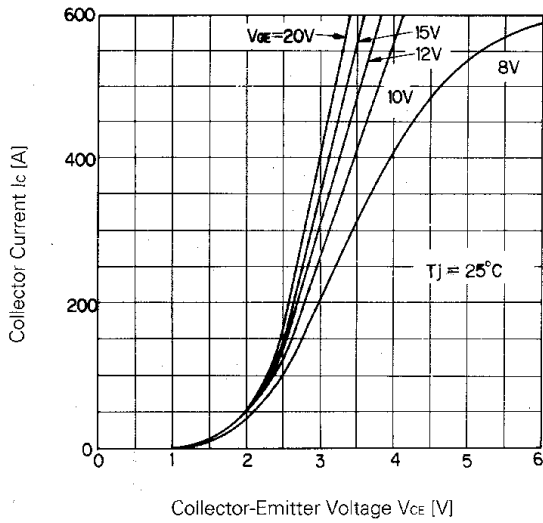

Collector Current vs. Collector-Emitter Voltage

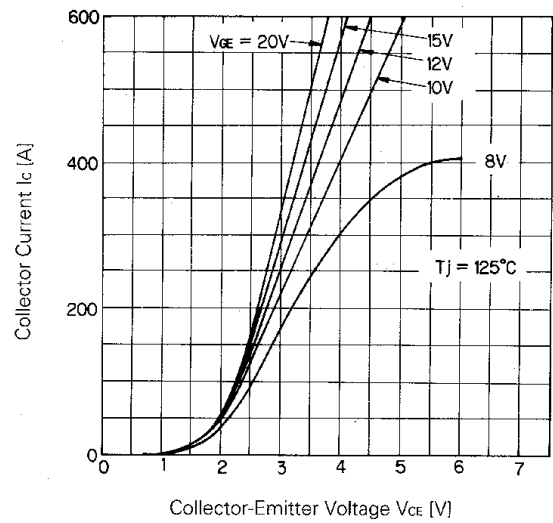

Collector Current vs. Collector-Emitter Voltage

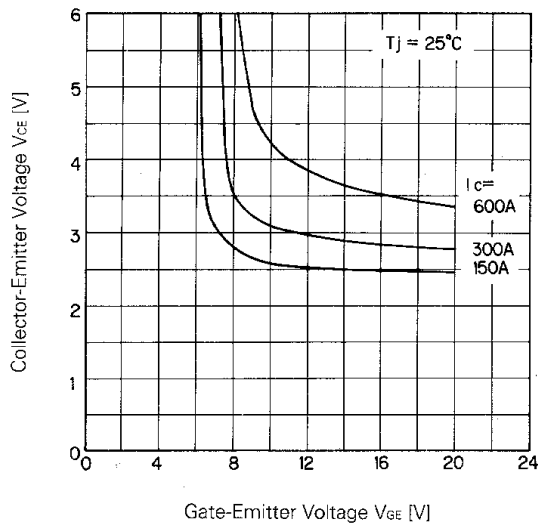

Collector-Emitter Voltage vs. Gate-Emitter Voltage

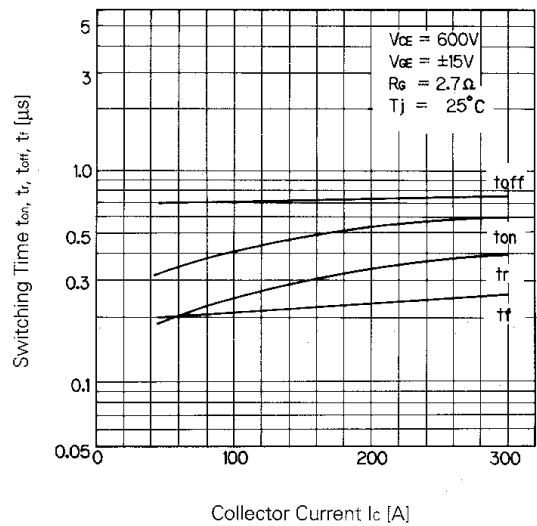

Switching Time

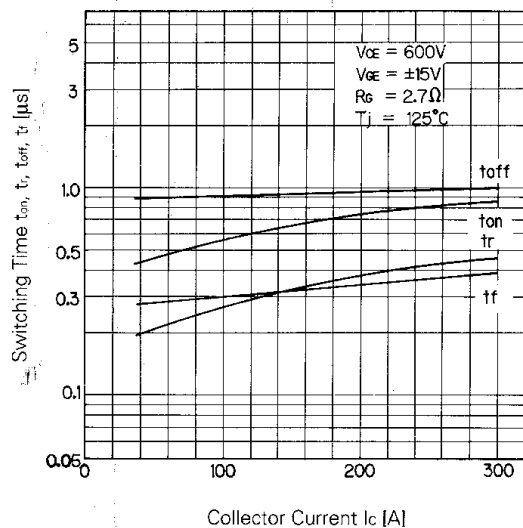

Switching Time

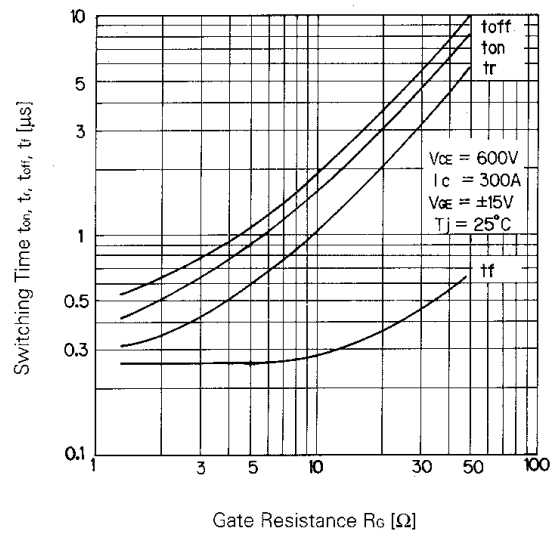

Switching Time-Gate Resistance

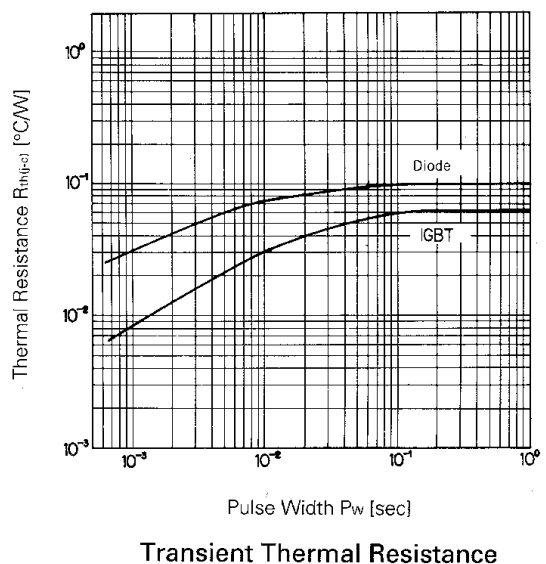
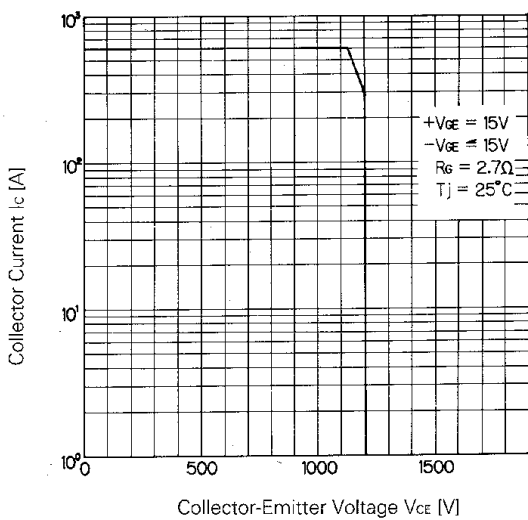
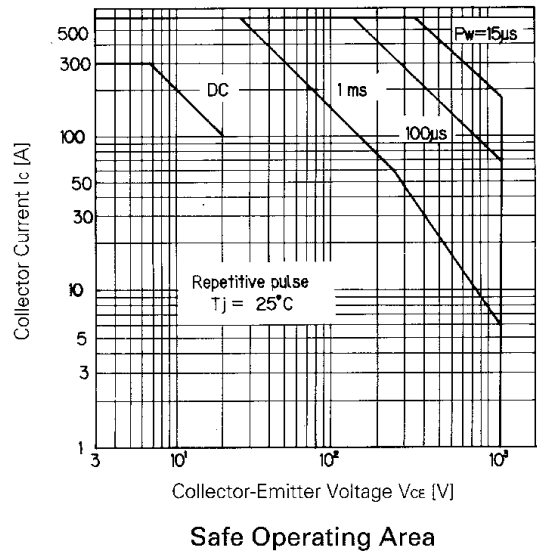
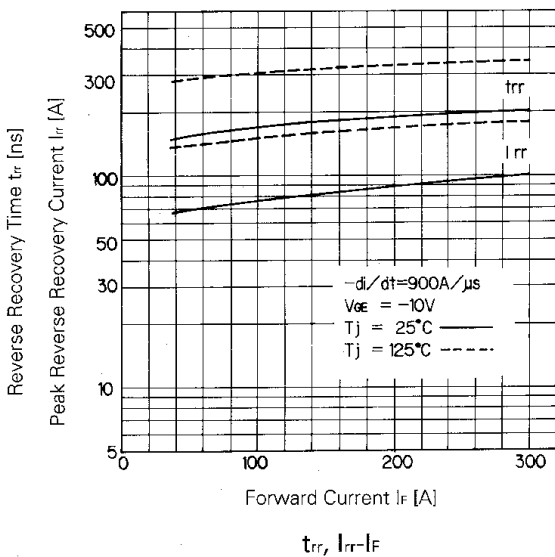
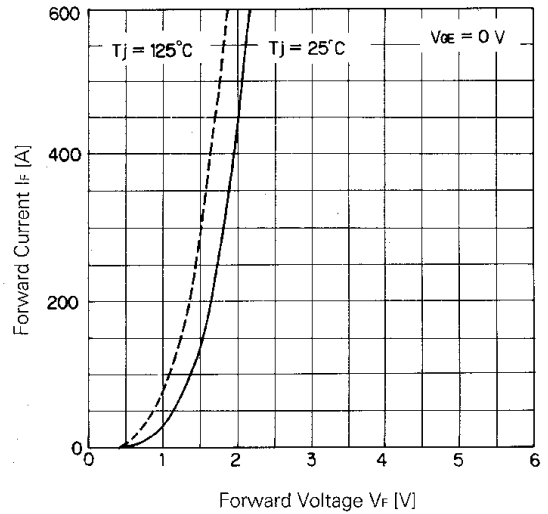
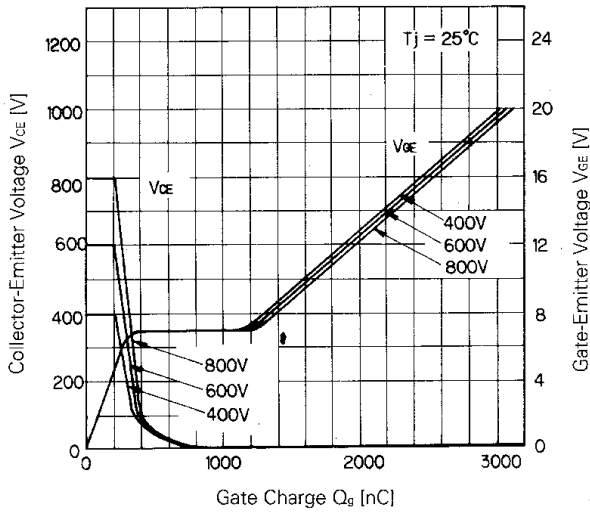

For more information, contact:

**Collmer Semiconductor, Inc.**

P.O. Box 702708

Dallas, TX 75370

972-733-1700

972-381-9991 Fax

<http://www.collmer.com>