

# 1MBI300N-120

IGBT Module

1200V / 300A 1 in one-package

## ■ Features

- High speed switching
- Voltage drive
- Low inductance module structure

## ■ Applications

- Inverter for Motor drive
- AC and DC Servo drive amplifier
- Uninterruptible power supply
- Industrial machines, such as Welding machines



## ■ Maximum ratings and characteristics

### ● Absolute maximum ratings (at $T_c=25^\circ\text{C}$ unless otherwise specified)

Item	Symbol	Rating	Unit
Collector-Emitter voltage	$V_{CES}$	1200	V
Gate-Emitter voltage	$V_{GES}$	$\pm 20$	V
Collector current	Continuous	$I_c$	300 A
	1ms	$I_c$ pulse	600 A
	Continuous	$-I_c$	300 A
	1ms	$-I_c$ pulse	600 A
Max. power dissipation	$P_c$	2100	W
Operating temperature	$T_j$	+150	$^\circ\text{C}$
Storage temperature	$T_{stg}$	-40 to +125	$^\circ\text{C}$
Isolation voltage	$V_{is}$	AC 2500 (1min.)	V
Screw torque	Mounting *1	3.5	N·m
	Terminals *2	4.5	N·m
	Terminals *3	1.7	N·m

\*1 : Recommendable value : 2.5 to 3.5 N·m(M5) or (M6)

\*2 : Recommendable value : 3.5 to 4.5 N·m(M6)

\*3 : Recommendable value : 1.3 to 1.7 N·m(M4)

### ■ Equivalent Circuit Schematic

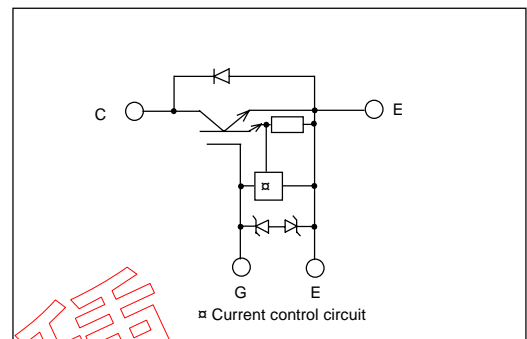

### ● Electrical characteristics (at $T_j=25^\circ\text{C}$ unless otherwise specified)

Item	Symbol	Characteristics			Conditions	Unit
		Min.	Typ.	Max.		
Zero gate voltage collector current	$I_{CES}$	—	—	4.0	$V_{GE}=0\text{V}$ , $V_{CE}=1200\text{V}$	mA
Gate-Emitter leakage current	$I_{GES}$	—	—	60	$V_{CE}=0\text{V}$ , $V_{GE}=\pm 20\text{V}$	$\mu\text{A}$
Gate-Emitter threshold voltage	$V_{GE(th)}$	4.5	—	7.5	$V_{CE}=20\text{V}$ , $I_c=300\text{mA}$	V
Collector-Emitter saturation voltage	$V_{CE(sat)}$	—	—	3.3	$V_{GE}=15\text{V}$ , $I_c=300\text{A}$	V
Input capacitance	$C_{ies}$	—	48000	—	$V_{GE}=0\text{V}$	pF
Output capacitance	$C_{oes}$	—	17400	—	$V_{CE}=10\text{V}$	
Reverse transfer capacitance	$C_{res}$	—	15480	—	$f=1\text{MHz}$	
Turn-on time	$t_{on}$	—	0.65	1.2	$V_{CC}=600\text{V}$	$\mu\text{s}$
	$t_r$	—	0.25	0.6	$I_c=300\text{A}$	
Turn-off time	$t_{off}$	—	0.95	1.5	$V_{GE}=\pm 15\text{V}$	$\mu\text{s}$
	$t_f$	—	0.35	0.5	$R_G=2.7\text{ohm}$	
Diode forward on voltage	$V_F$	—	—	3.0	$I_F=300\text{A}$ , $V_{GE}=0\text{V}$	V
Reverse recovery time	$t_{rr}$	—	—	0.35	$I_F=300\text{A}$	$\mu\text{s}$

### ● Thermal resistance characteristics

Item	Symbol	Characteristics			Conditions	Unit
		Min.	Typ.	Max.		
Thermal resistance	$R_{th(j-c)}$	—	—	0.06	IGBT	$^\circ\text{C/W}$
	$R_{th(j-c)}$	—	—	0.17	Diode	$^\circ\text{C/W}$
	$R_{th(c-f)}$ *4	—	0.0125	—	the base to cooling fin	$^\circ\text{C/W}$

\*4 : This is the value which is defined mounting on the additional cooling fin with thermal compound

Characteristics (Representative)

Collector current vs. Collector-Emitter voltage  
T<sub>J</sub>=25°C

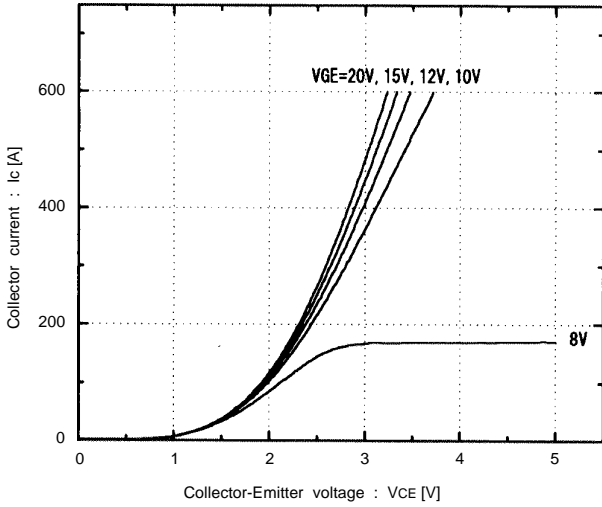

Collector current vs. Collector-Emitter voltage  
T<sub>J</sub>=125°C

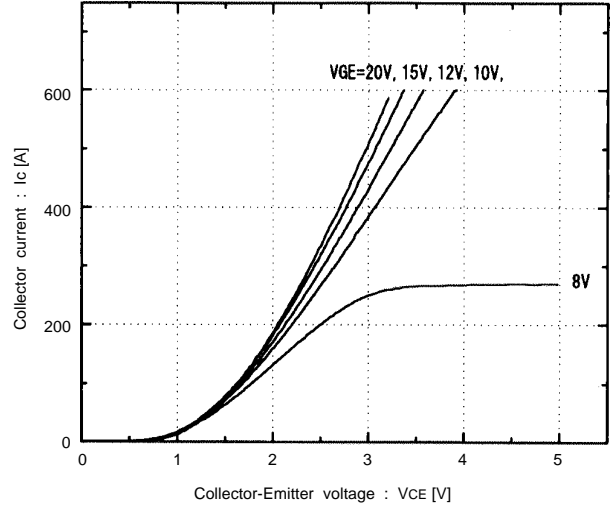

Collector-Emitter vs. Gate-Emitter voltage  
T<sub>J</sub>=25°C

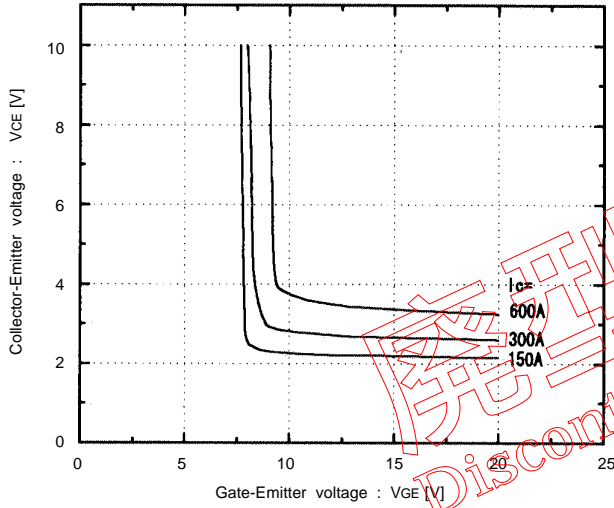

Collector-Emitter vs. Gate-Emitter voltage  
T<sub>J</sub>=125°C

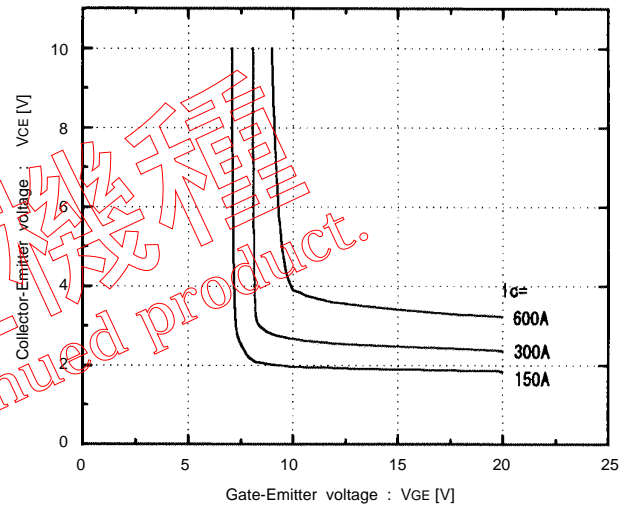

Switching time vs. Collector current  
V<sub>CC</sub>=600V, R<sub>G</sub>=2.7 ohm, V<sub>GE</sub>=±15V, T<sub>J</sub>=25°C

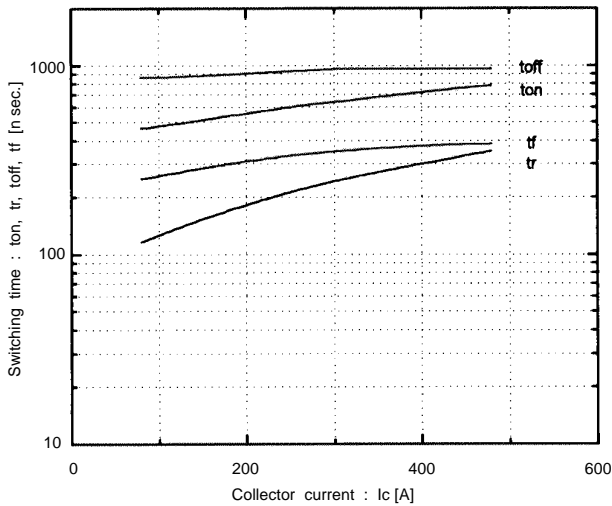

Switching time vs. Collector current  
V<sub>CC</sub>=600V, R<sub>G</sub>=2.7 ohm, V<sub>GE</sub>=±15V, T<sub>J</sub>=125°C

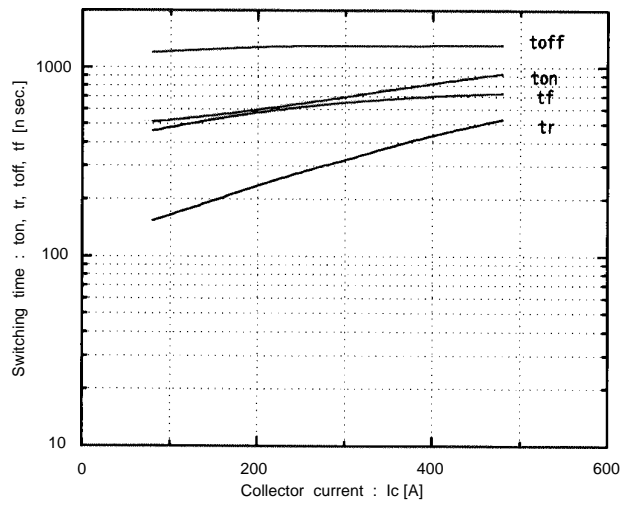

Switching time vs.  $R_G$   
 $V_{CC}=600V, I_c=300A, V_{GE}=\pm 15V, T_j=25^\circ C$

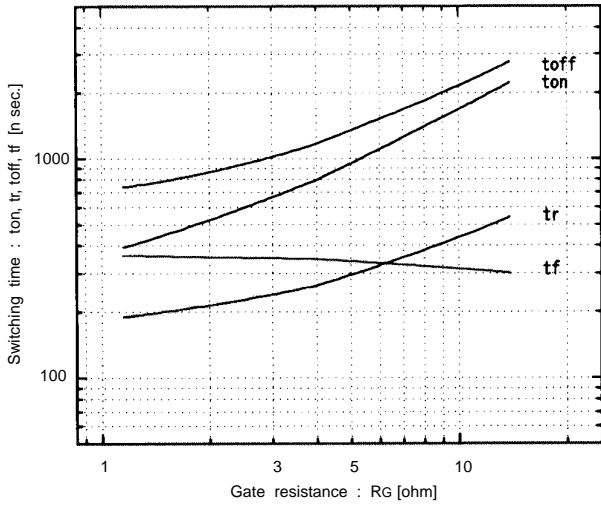

Dynamic input characteristics  
 $T_j=25^\circ C$

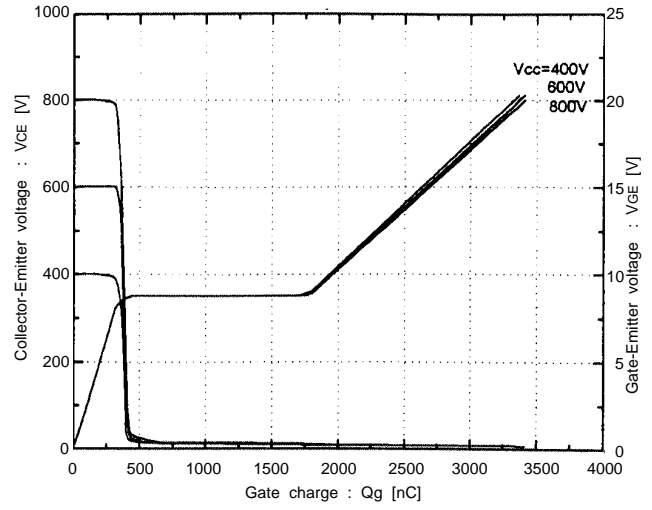

Forward current vs. Forward voltage  
 $V_{GE}=0V$

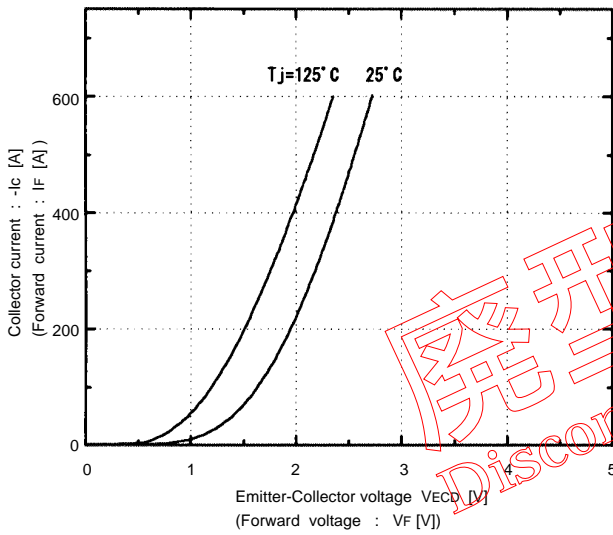

Reverse recovery characteristics  
 $t_{rr}, I_{rr}$ , vs.  $I_F$

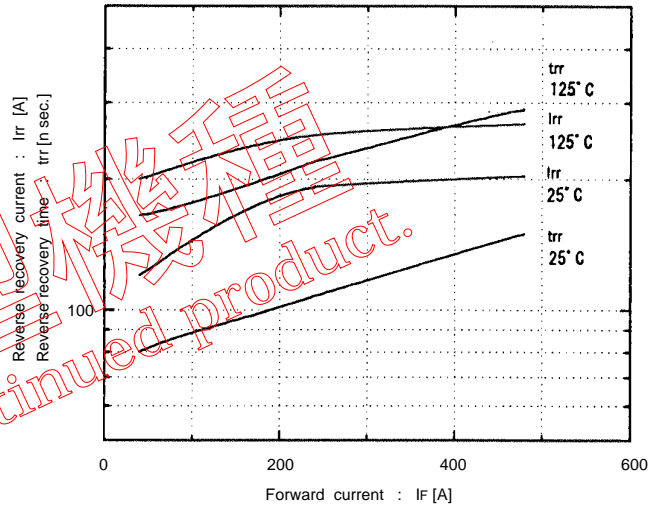

Switching loss vs. Collector current  
 $V_{CC}=600V, R_G=2.7\text{ ohm}, V_{GE}=\pm 15V$

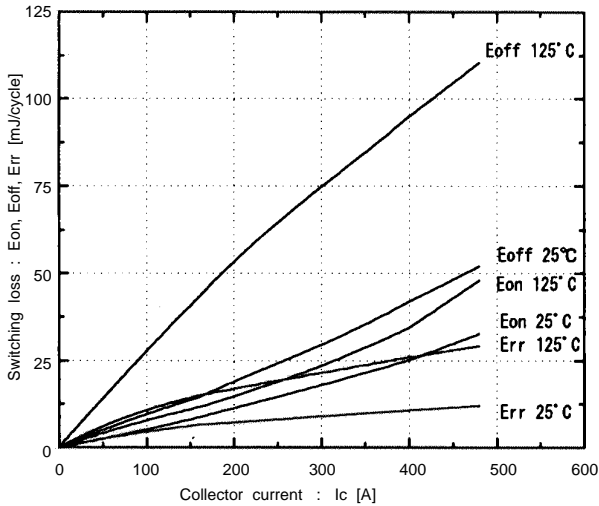

Reversed biased safe operating area  
 $+V_{GE}=15V, -V_{GE} \le 15V, T_j \le 125^\circ C, R_G \ge 2.7\text{ ohm}$

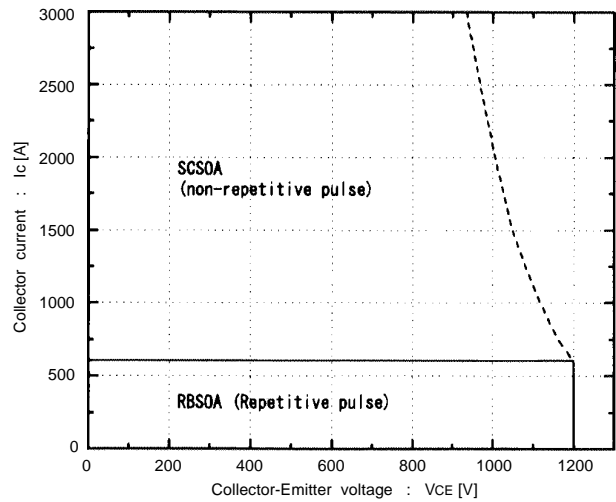

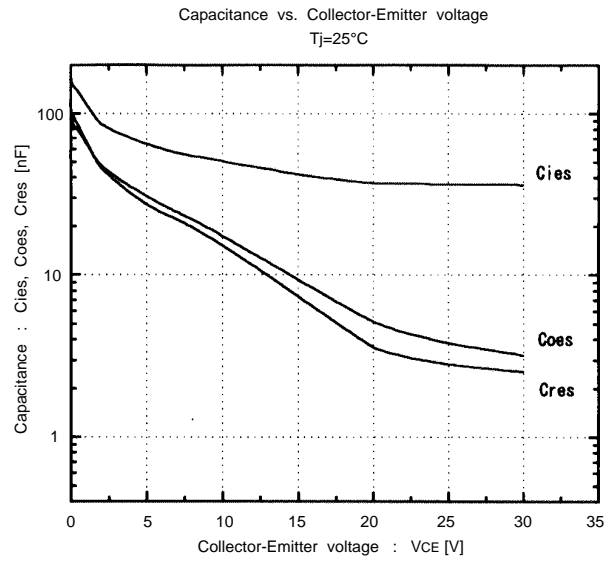
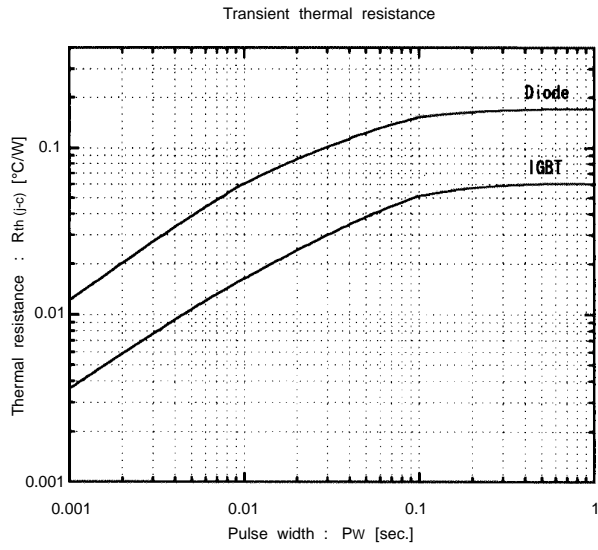

■ Outline Drawings, mm

