

IGBT MODULE (L series)

■ Features

- High Speed Switching
- Low Saturation Voltage
- Voltage Drive
- Isolated Package

■ Applications

- Ideal for Chopper Application
- AC and DC Servo Drive Supply
- Uninterruptible Power Supply
- Industrial Machines, such as Welding Machines

■ Maximum Ratings and Characteristics

● Absolute Maximum Ratings

Items	Symbols	Ratings	Units
Collector-Emitter Voltage	V_{CES}	600	V
Gate-Emitter Voltage	V_{GES}	± 20	V
Collector Current	Continuous	I_C	50
	1ms	$I_{C,pulse}$	100
			A
Max. Power Dissipation	P_C	200	W
Operating Temperature	T_J	+150	$^{\circ}C$
Storage Temperature	T_{stg}	-40 to +125	$^{\circ}C$
Isolation Voltage	AC, 1min.	V_{is}	2500
Screw Torque	Mounting *1	1.7	N•m
	Terminals *1	1.7	

● Electrical Characteristics ($T_J=25^{\circ}C$ unless otherwise specified)

Items	Symbols	Test Conditions	Min.	Typ.	Max.	Units
Zero Gate Voltage Collector Current	I_{CES}	$V_{GE}=0V$ $V_{CE}=600V$ $T_C=25^{\circ}C$			1.0	mA
Gate-Emitter Leakage Current	I_{GES}	$V_{CE}=0V$ $V_{GE}=\pm 20V$			100	nA
Gate-Emitter Threshold Voltage	$V_{GE(th)}$	$V_{CE}=20V$ $I_C=50mA$	3.0		6.0	V
Collector-Emitter Saturation Voltage	$V_{CE(sat)}$	$V_{GE}=15V$ $I_C=50A$		2.7	3.5	V
Input Capacitance	C_{ies}	$V_{GE}=0V$		4750		pF
Output Capacitance	C_{oes}	$V_{CE}=10V$		-		
Reverse Transfer Capacitance	C_{res}	$f=1MHz$		-		
Turn-on Time	t_{on}	$V_{CC}=300V$		0.4	0.8	μs
	t_r	$I_C=50A$		0.3	0.6	
Turn-off Time	t_{off}	$V_{GE}=\pm 15V$		0.6	1.0	
	t_t	$R_G=51\Omega$		0.2	0.35	

t_{on}, t_r : Resistive Load t_{off}, t_t : Inductive Load

● Thermal Characteristics

Items	Symbols	Test Conditions	Min.	Typ.	Max.	Units
Thermal Resistance	$R_{th(j-c)}$	IGBT			0.625	$^{\circ}C/W$
	$R_{th(c-f)}$	With Thermal compound		0.05		

■ Outline Drawings

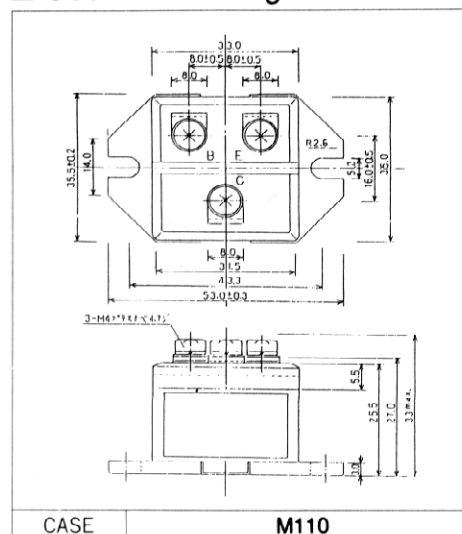

■ Equivalent Circuit Schematic

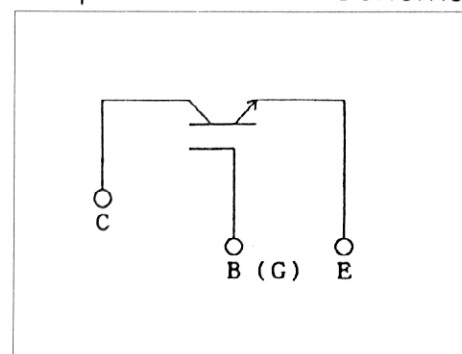

*1 Recommendable Value 1.3 ~ 1.7 N•m (M4)

■ Characteristics

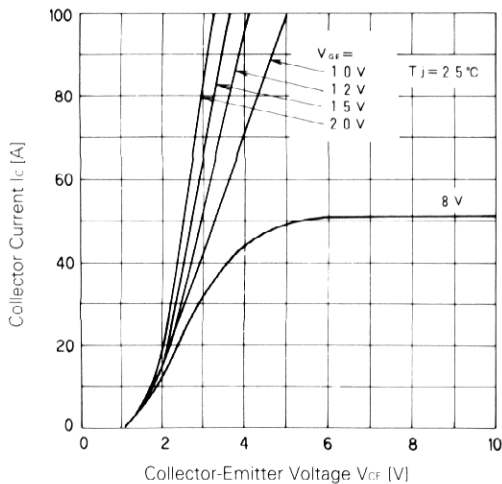

Collector Current vs. Collector-Emitter Voltage

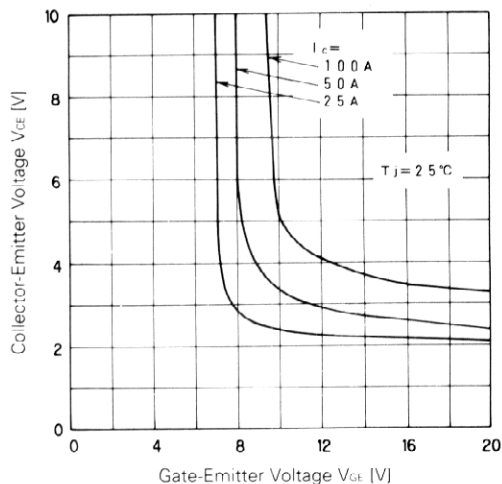

Collector-Emitter Voltage vs. Gate-Emitter Voltage

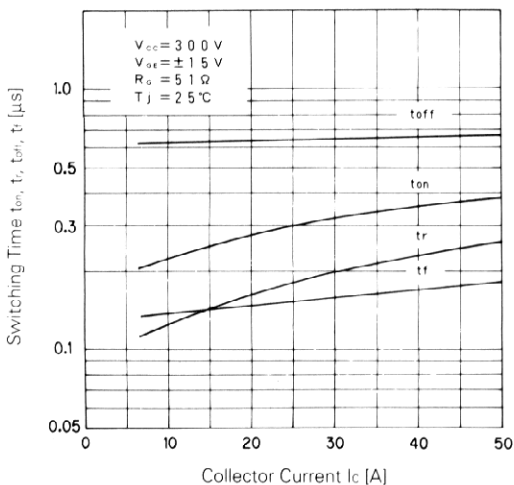

Switching Time

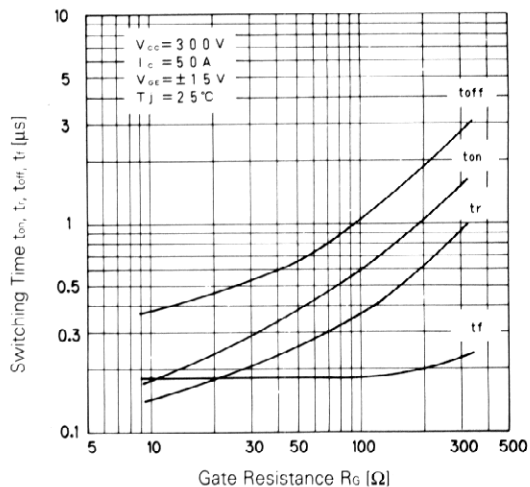

Switching Time-Gate Resistance

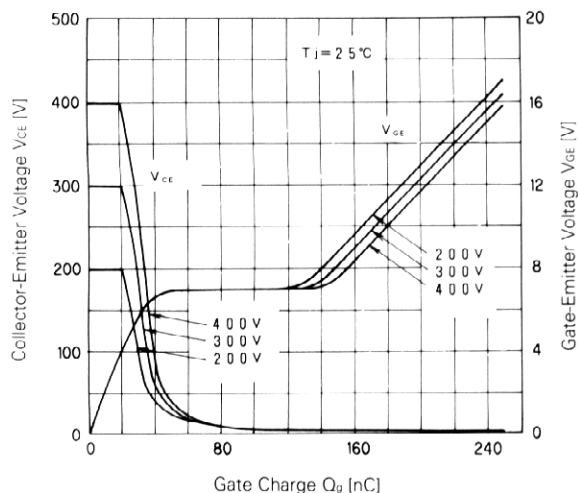

Dynamic Input Characteristic

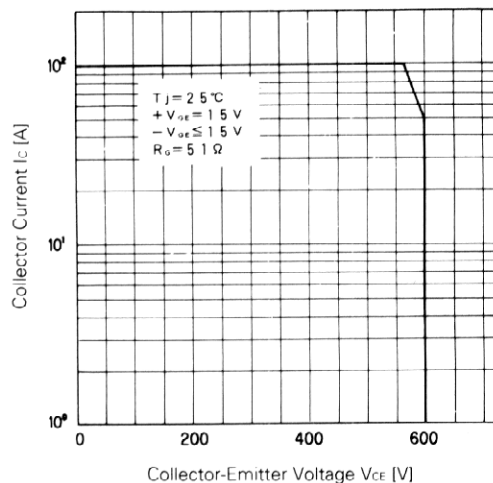

Reverse Biased Safe Operating Area

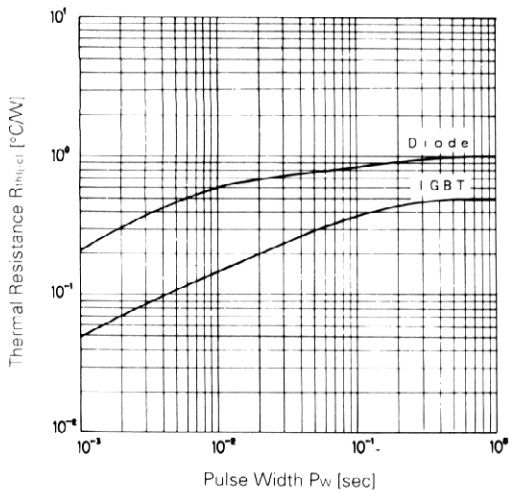

Transient Thermal Resistance

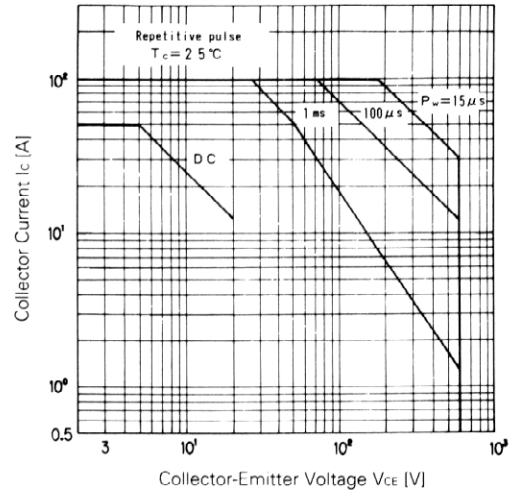

Safe Operating Area