

1MBI600NP-060

1MBI600NN-060

IGBT Module

600V / 600A 1 in one-package

■ Features

- High speed switching
- Voltage drive
- Low inductance module structure

■ Applications

- Inverter for Motor drive
- AC and DC Servo drive amplifier
- Uninterruptible power supply
- Industrial machines, such as Welding machines



■ Maximum ratings and characteristics

● Absolute maximum ratings (at Tc=25°C unless otherwise specified)

Item	Symbol	Rating	Unit
Collector-Emitter voltage	V _{CE} S	600	V
Gate-Emitter voltage	V _{GE} S	±20	V
Collector current	Continuous	I _C	600 A
	1ms	I _C pulse	1200 A
	Continuous	-I _C	600 A
	1ms	-I _C pulse	1200 A
Max. power dissipation	P _C	2000	W
Operating temperature	T _J	+150	°C
Storage temperature	T _{stg}	-40 to +125	°C
Isolation voltage	V _{is}	AC 2500 (1min.)	V
Screw torque	Mounting *1	3.5	N·m
	Terminals *2	4.5	N·m
	Terminals *3	1.7	N·m

*1: Recommendable value : 2.5 to 3.5 N·m (M5) or (M6)

*2: Recommendable value : 3.5 to 4.5 N·m (M6)

*3: Recommendable value : 1.3 to 1.7 N·m (M4)

■ Equivalent Circuit Schematic

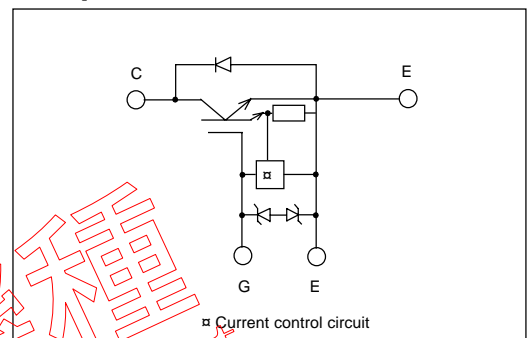

● Electrical characteristics (at Tj=25°C unless otherwise specified)

Item	Symbol	Characteristics			Conditions	Unit
		Min.	Typ.	Max.		
Zero gate voltage collector current	I _{CE} S	-	-	4.0	V _{GE} =0V, V _{CE} =600V	mA
Gate-Emitter leakage current	I _{GES}	-	-	60	V _{CE} =0V, V _{GE} =±20V	μA
Gate-Emitter threshold voltage	V _{GE(th)}	4.5	-	7.5	V _{CE} =20V, I _C =600mA	V
Collector-Emitter saturation voltage	V _{CE(sat)}	-	-	2.8	V _{GE} =15V, I _C =600A	V
Input capacitance	C _{ies}	-	39600	-	V _{GE} =0V	pF
Output capacitance	C _{oes}	-	8800	-	V _{CE} =10V	
Reverse transfer capacitance	C _{res}	-	4000	-	f=1MHz	
Turn-on time	t _{on}	-	0.6	1.2	V _{CC} =300V	μs
	t _r	-	0.2	0.6	I _C =600A	
Turn-off time	t _{off}	-	0.6	1.0	V _{GE} =±15V	μs
	t _f	-	0.2	0.35	R _G =2.7 ohm	
Diode forward on voltage	V _F	-	-	3.0	I _F =600A, V _{GE} =0V	V
Reverse recovery time	t _{rr}	-	-	0.3	I _F =600A	μs

● Thermal resistance characteristics

Item	Symbol	Characteristics			Conditions	Unit
		Min.	Typ.	Max.		
Thermal resistance	R _{th(j-c)}	-	-	0.063	IGBT	°C/W
	R _{th(j-c)}	-	-	0.11	Diode	°C/W
	R _{th(c-f)} *4	-	0.0125	-	the base to cooling fin	°C/W

*4 : This is the value which is defined mounting on the additional cooling fin with thermal compound

Characteristics (Representative)

Collector current vs. Collector-Emitter voltage
T_J=25°C

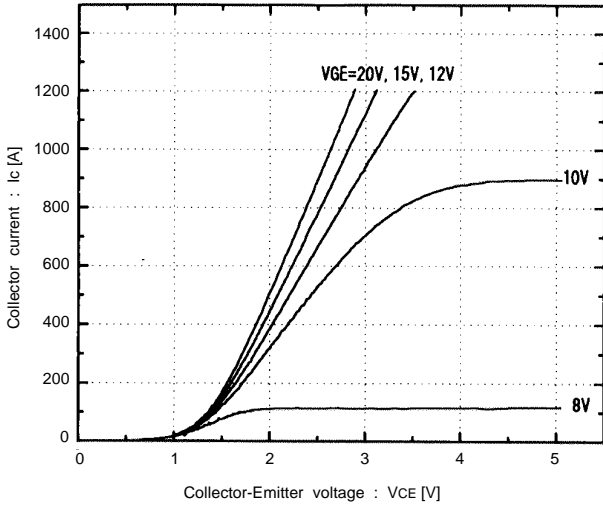

Collector current vs. Collector-Emitter voltage
T_J=125°C

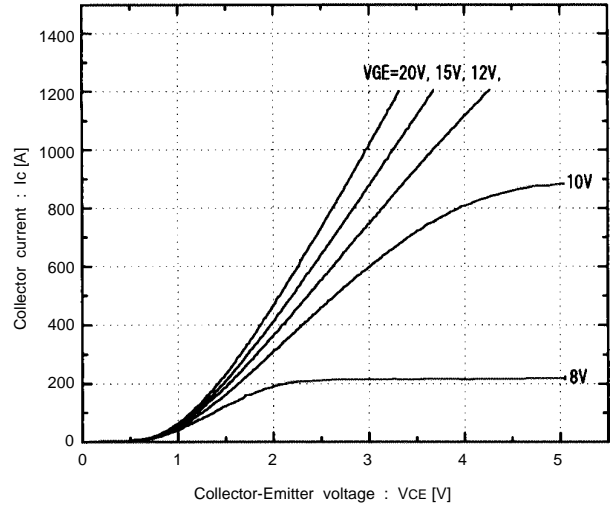

Collector-Emitter vs. Gate-Emitter voltage
T_J=25°C

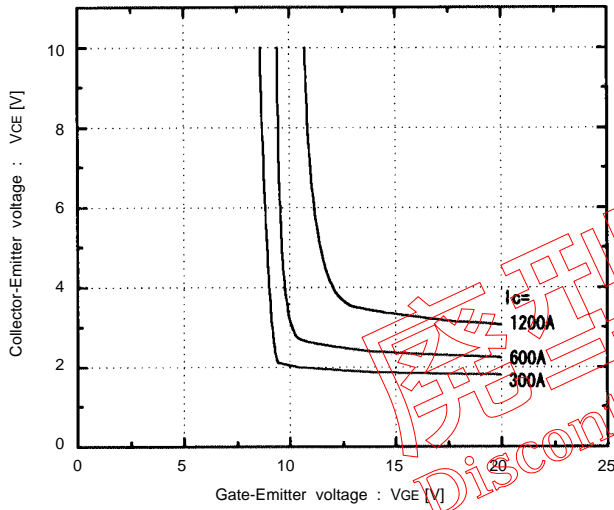

Collector-Emitter vs. Gate-Emitter voltage
T_J=125°C

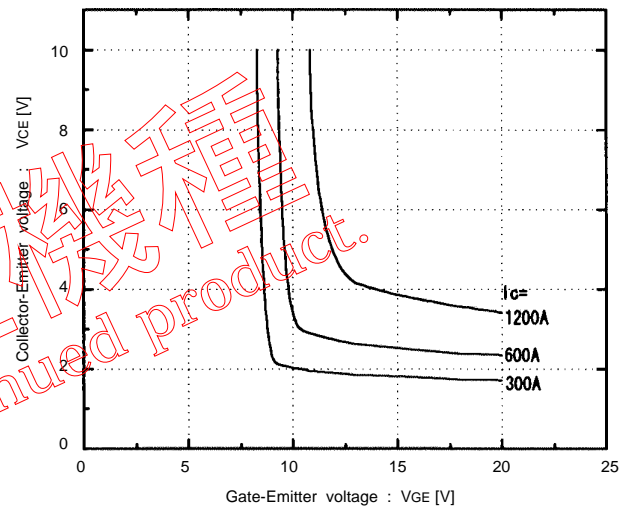

Switching time vs. Collector current
V_{CC}=300V, R_G=2.7 ohm, V_{GE}=±15V, T_J=25°C

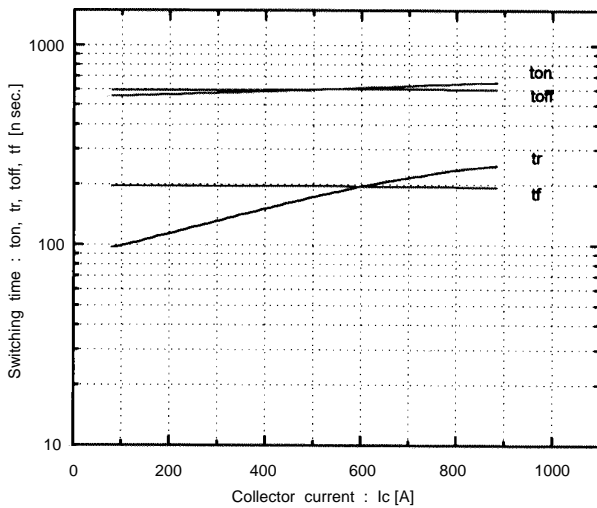

Switching time vs. Collector current
V_{CC}=300V, R_G=2.7 ohm, V_{GE}=±15V, T_J=125°C

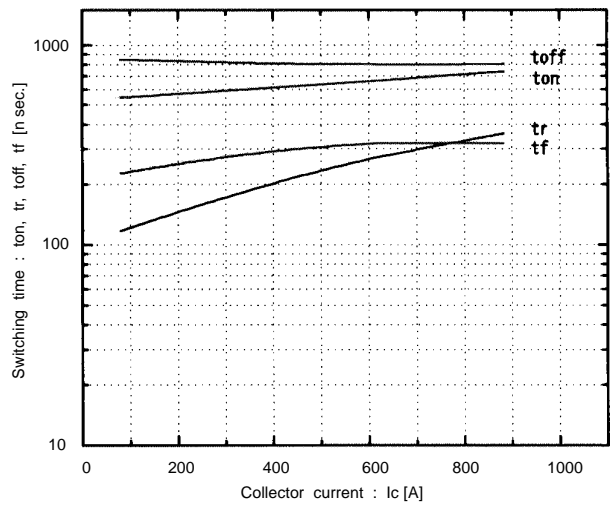

廢型機種
 Discontinued product.

Switching time vs. R_G
 $V_{CC}=300V, I_c=600A, V_{GE}=\pm 15V, T_j=25^\circ C$

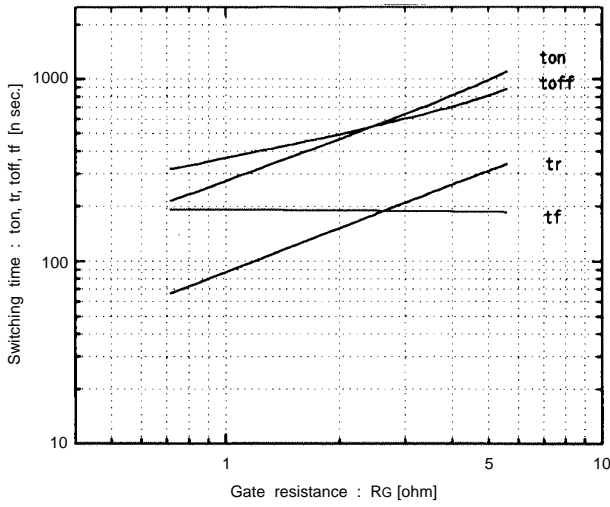

Dynamic input characteristics
 $T_j=25^\circ C$

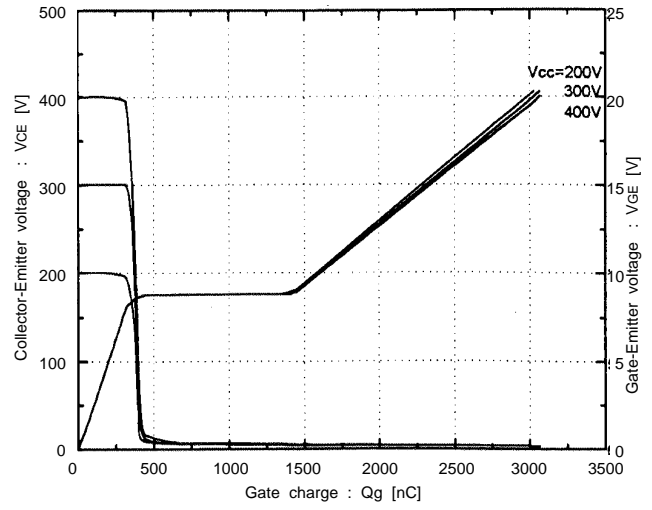

Forward current vs. Forward voltage
 $V_{GE}=0V$

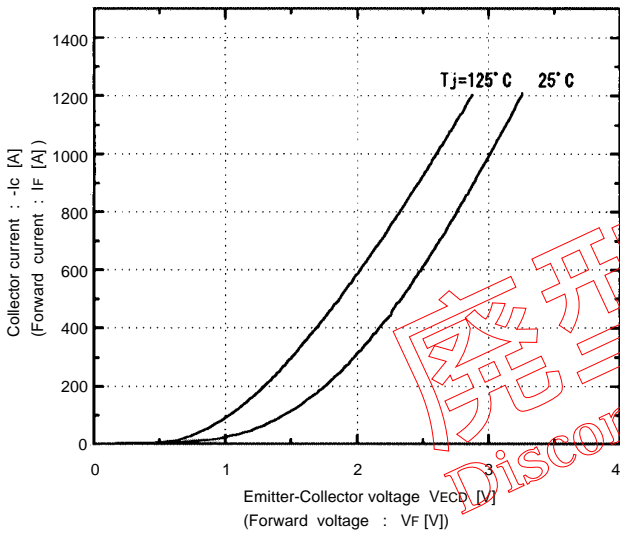

Reverse recovery characteristics
 t_{rr}, I_{rr} , vs. I_F

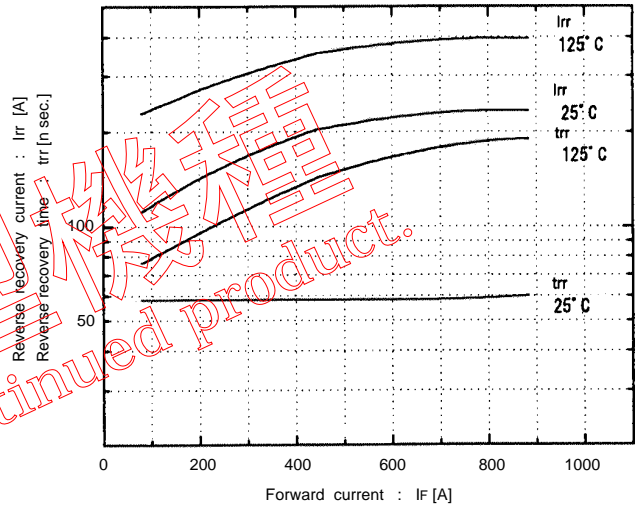

Switching loss vs. Collector current
 $V_{CC}=300V, R_G=2.7 \text{ ohm}, V_{GE}=\pm 15V$

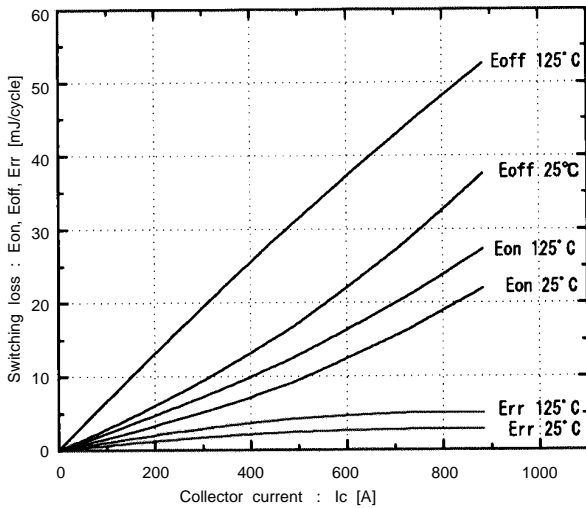

Reversed biased safe operating area
 $+V_{GE}=15V, -V_{GE} \leq 15V, T_j \leq 125^\circ C, R_G \geq 2.7 \text{ ohm}$

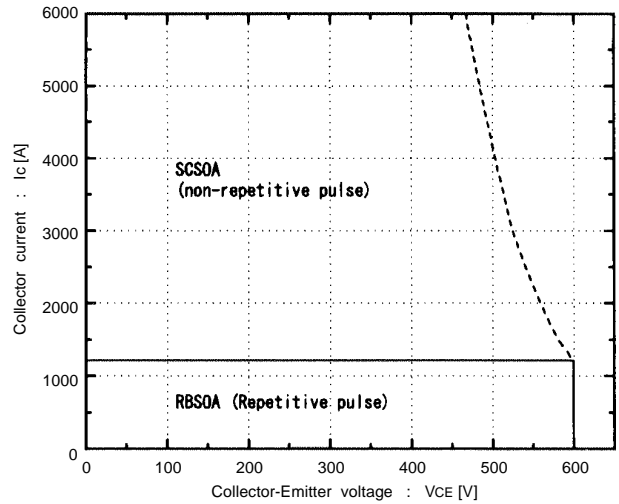

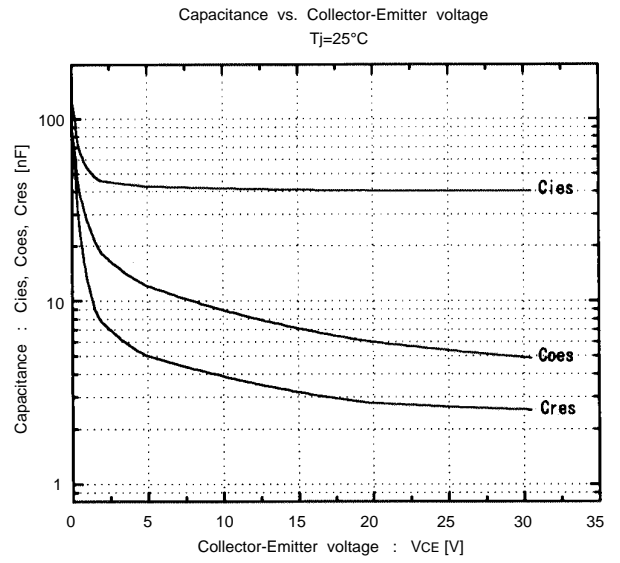
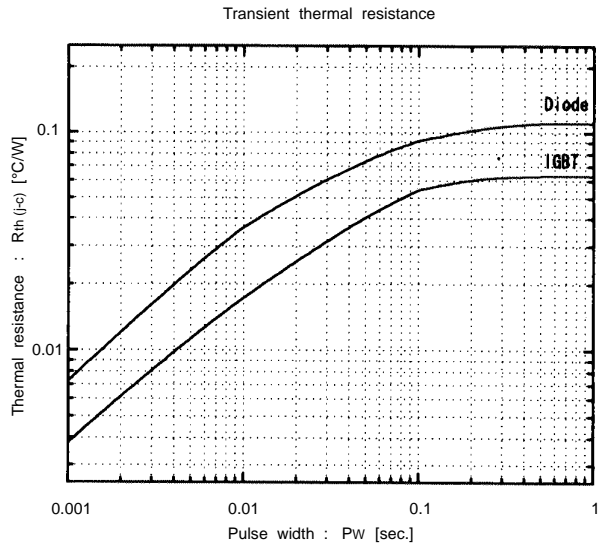

■ Outline Drawings, mm

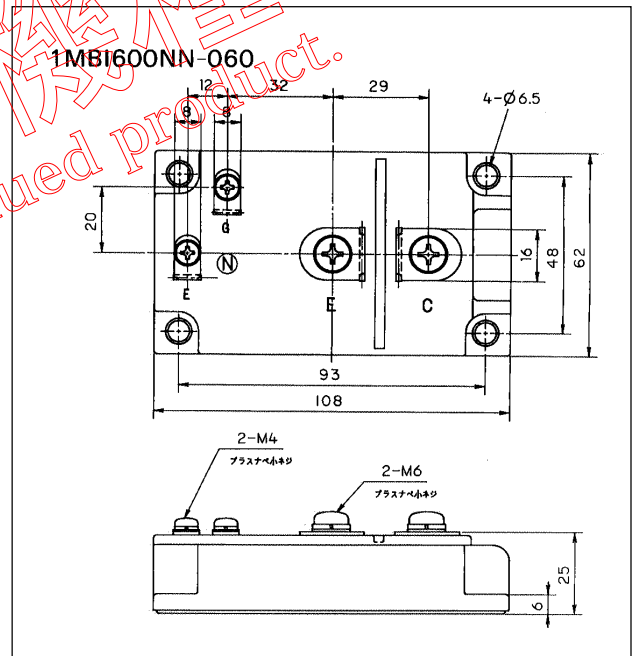
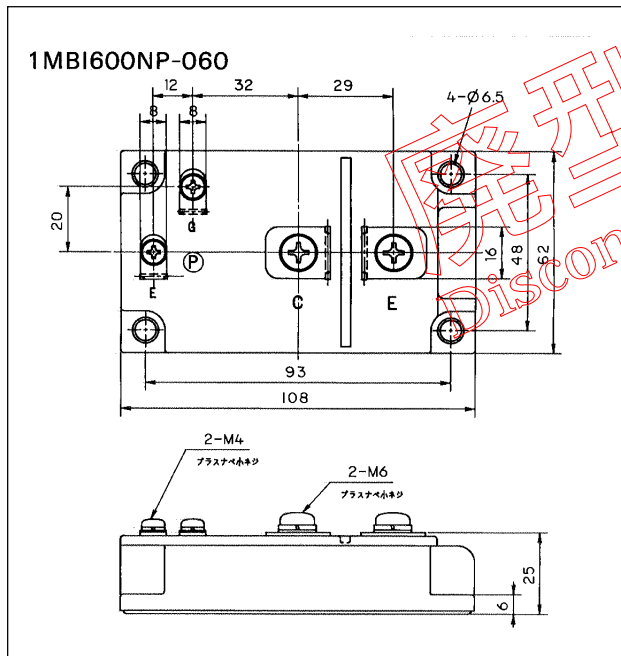

mass : 370g