

1MBK50D-060S

Molded IGBT

600V / 50A Molded Package

■ Features

- Small molded package
- Low power loss
- Soft switching with low switching surge and noise
- High reliability, high ruggedness (RBSOA, SCSOA etc.)
- Comprehensive line-up

■ Applications

- Inverter for Motor drive
- AC and DC Servo drive amplifier
- Uninterruptible power supply

■ Maximum ratings and characteristics

● Absolute maximum ratings (Tc=25°C)

Item	Symbol	Rating	Unit
Collector-Emitter voltage	V _{CES}	600	V
Gate-Emitter voltage	V _{GES}	±20	V
Collector current	DC	T _c =25°C	I _{C25} 65 A
		T _c =100°C	I _{C100} 50 A
	1ms	T _c =25°C	I _{CP} 150 A
Max. power dissipation (IGBT)	P _C	200	W
Max. power dissipation (FWD)	P _C	130	W
Operating temperature	T _j	+150	°C
Storage temperature	T _{stg}	-40 to +150	°C
Screw torque	-	39.2 to 58.8	N·cm

■ Equivalent Circuit Schematic

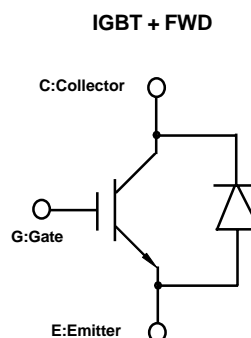

● Electrical characteristics (at Tc=25°C unless otherwise specified)

Item	Symbol	Characteristics			Conditions	Unit	
		Min.	Typ.	Max.			
Zero gate voltage collector current	I _{CES}	-	-	1.0	V _{GE} =0V, V _{CES} =600V	mA	
Gate-Emitter leakage current	I _{GES}	-	-	10	V _{CE} =0V, V _{GE} =±20V	μA	
Gate-Emitter threshold voltage	V _{GE(th)}	4.0	5.0	6.0	V _{CE} =20V, I _C =50mA	V	
Collector-Emitter saturation voltage	V _{CE(sat)}	-	2.4	2.9	V _{GE} =15V, I _C =50A	V	
Input capacitance	C _{ies}	-	2500	-	V _{GE} =0V	pF	
Output capacitance	C _{oes}	-	240	-	V _{CE} =25V		
Reverse transfer capacitance	C _{res}	-	130	-	f=1MHz		
Switching Time	Turn-on time	t _{on} *	-	0.15	-	V _{CC} =300V, I _C =50A	μs
		t _r *	-	0.09	-	V _{GE} =±15V	
		t _{rr2}	-	0.03	-	R _G =33 ohm	
	Turn-off time	t _{off}	-	0.50	0.62	(Half Bridge)	
		t _f	-	0.10	0.17	Inductance Load	
		Turn-on time	t _{on} *	-	0.15	-	
	t _r *		-	0.09	-	V _{GE} =+15V	
	t _{rr2}		-	0.03	-	R _G =8 ohm	
Turn-off time	t _{off}	-	0.50	0.62	(Half Bridge)		
	t _f	-	0.10	0.17	Inductance Load		
	FWD forward on voltage	V _F	-	2.0	2.5	I _F =50A, V _{GE} =0V	V
Reverse recovery time	t _{rr}	-	0.06	0.10	I _F =50A, V _{GE} =-10V, V _R =300V, di/dt=100A/μs	μs	

*Turn-on characteristics include t_{rr2}. See a figure in next page.

● Thermal resistance characteristics

Item	Symbol	Characteristics			Conditions	Unit
		Min.	Typ.	Max.		
Thermal resistance	R _{th(j-c)}	-	-	0.63	IGBT	°C/W
	R _{th(j-c)}	-	-	0.96	FWD	°C/W

Outline drawings, mm

TO-247

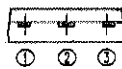
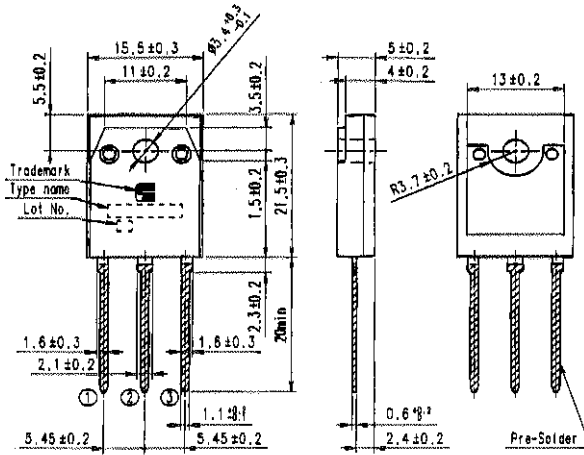

CONNECTION

- ① Gate
- ② Collector
- ③ Emitter

Switching waveform (Inductance load)

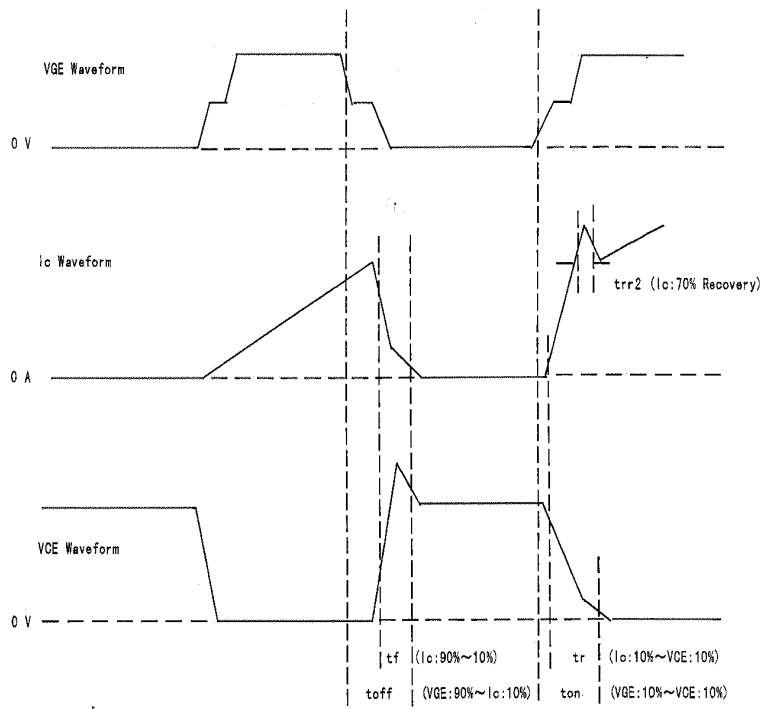

Mesurement circuit

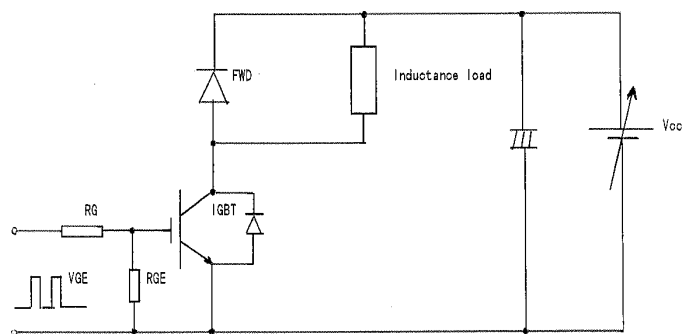

Characteristics

Collector current vs. Collector-Emitter voltage
T_j=25°C

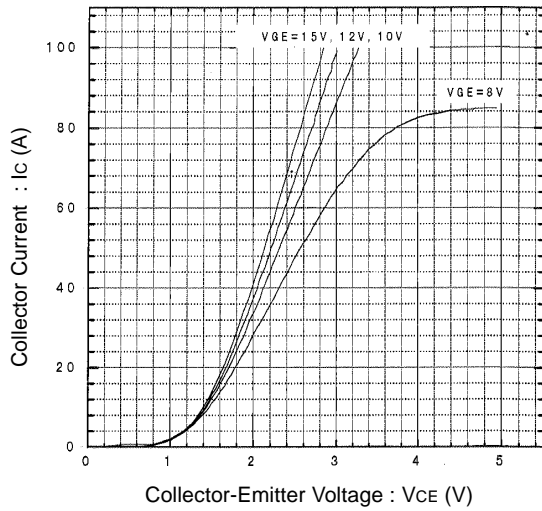

Collector current vs. Collector-Emitter voltage
T_j=125°C

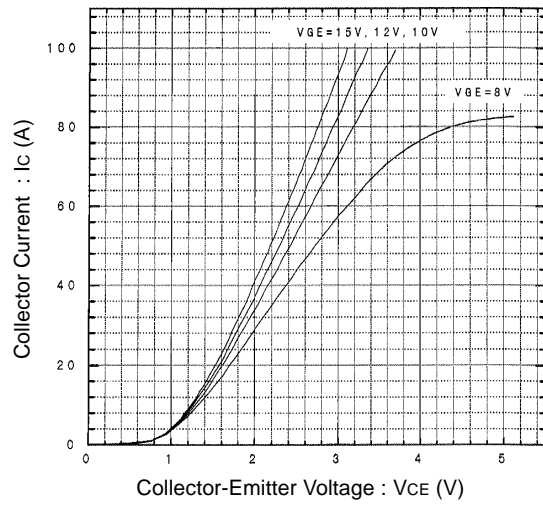

Collector-Emitter voltage vs. Gate-Emitter voltage
T_j=25°C

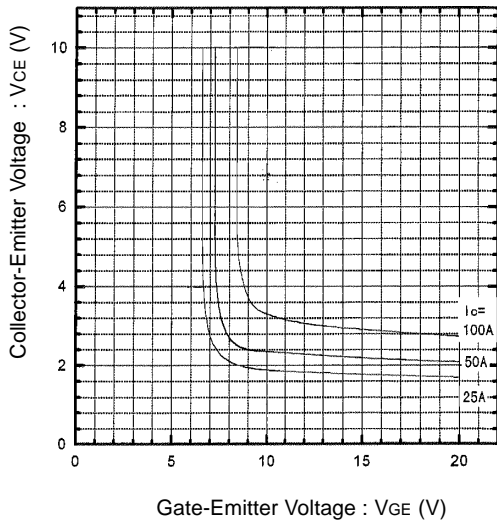

Collector-Emitter voltage vs. Gate-Emitter voltage
T_j=125°C

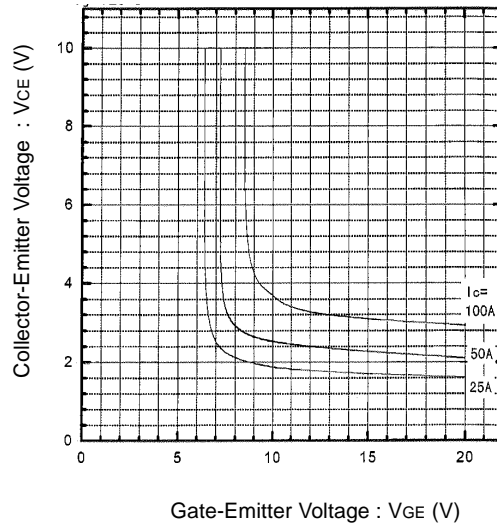

Switching time vs. Collector current
V_{CC}=300V, R_G=8Ω, V_{GE}=+15V, T_j=125°C

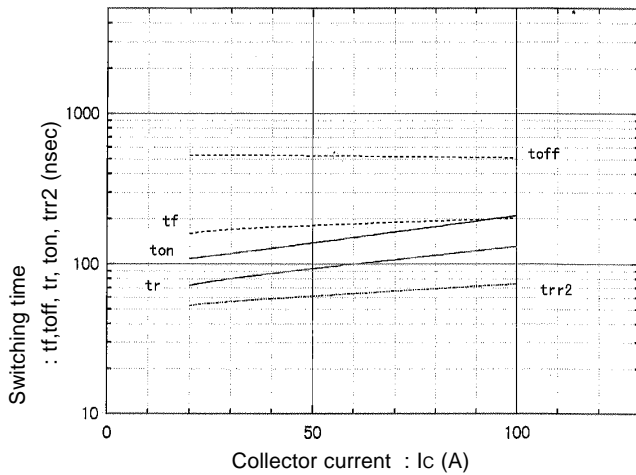

Switching time vs. Collector current
V_{CC}=300V, R_G=33Ω, V_{GE}=±15V, T_j=125°C

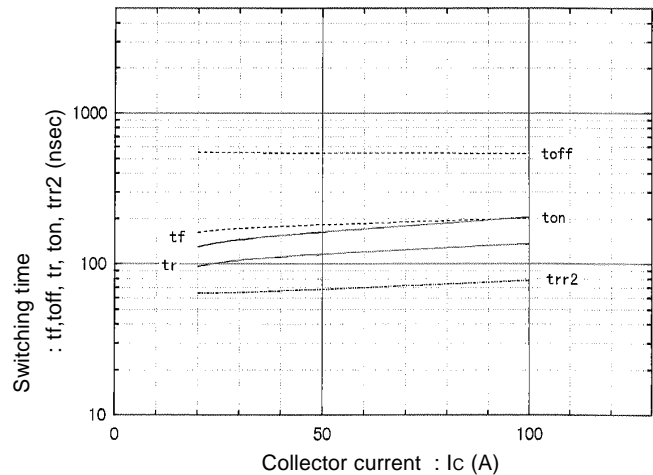

Characteristics

Switching time vs. R_G

V_{CC}=300V, I_C=50A, V_{GE}=+15V, T_J=125°C

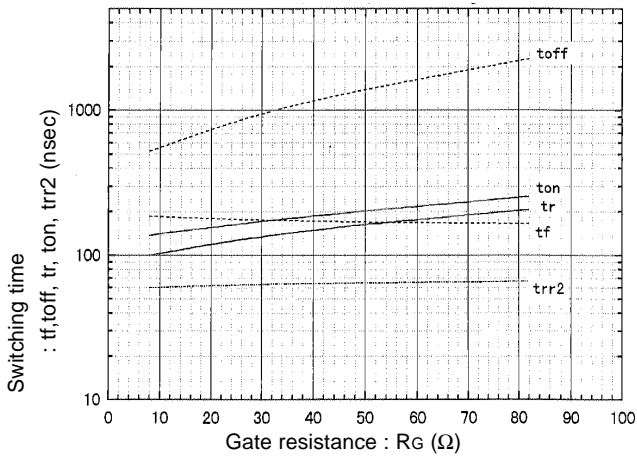

Switching time vs. R_G

V_{CC}=300V, I_C=50A, V_{GE}=±15V, T_J=125°C

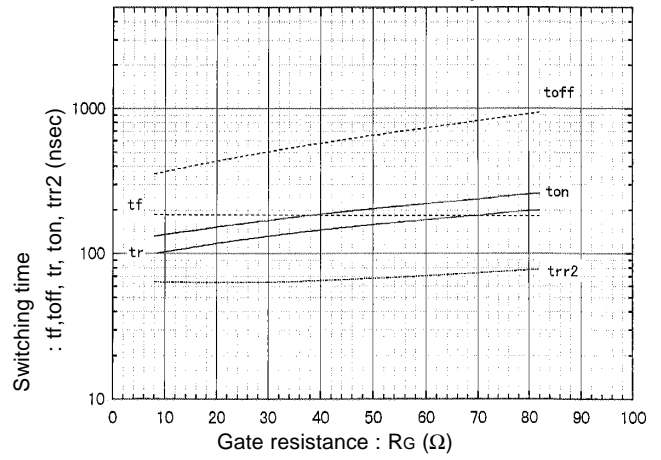

Dynamic input characteristics

T_J=25°C

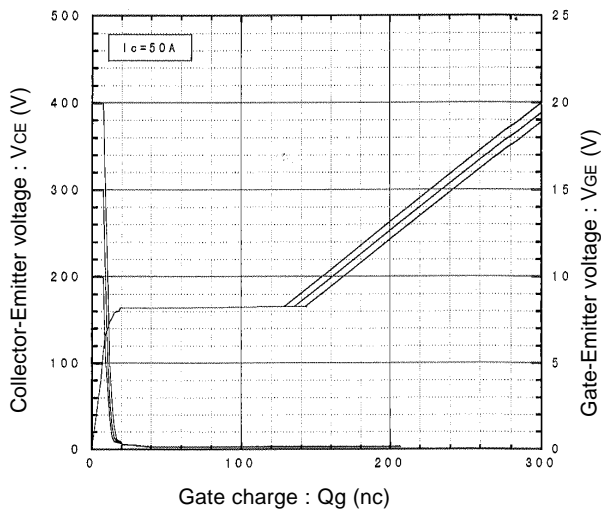

Capacitance vs. Collector-Emitter voltage

T_J=25°C

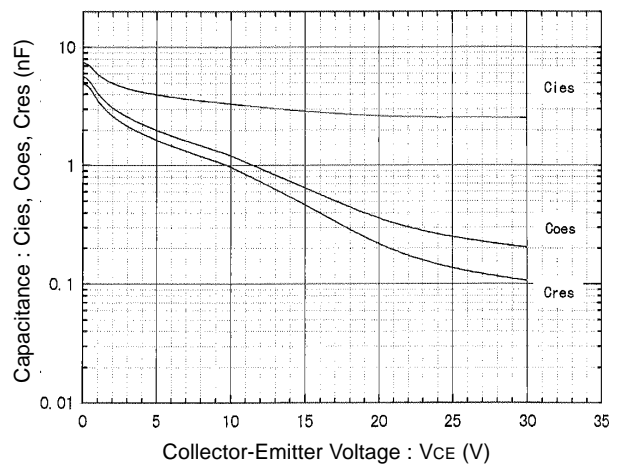

Reverse Biased Safe Operating Area

R_G=8Ω, +V_{GE} ≤ 20V, -V_{GE}=15V, T_J ≤ 125°C

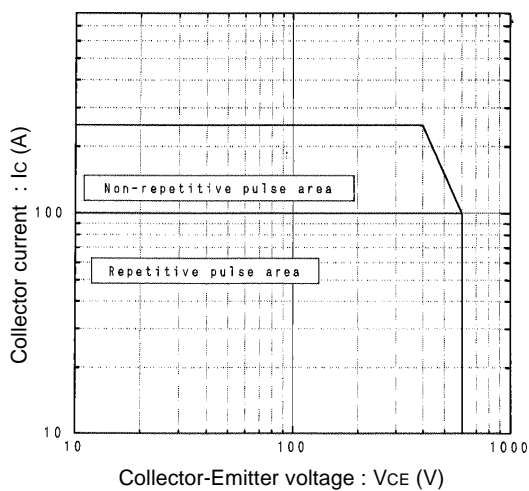

Forward Bias Safe Operating Area

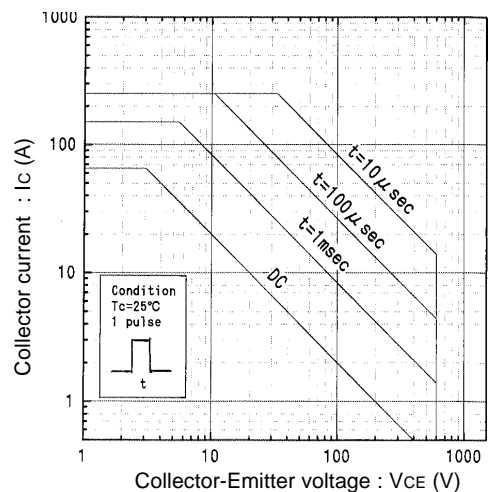

■ Characteristics

Reverse recovery time vs. Forward current
 $V_R=300V, -di/dt=100A/\mu sec$

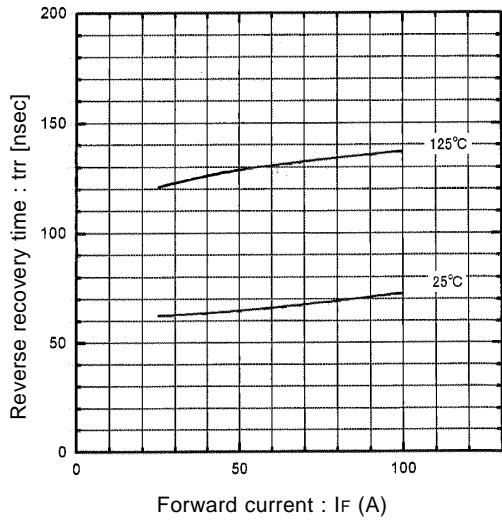

Reverse recovery current vs. Forward current
 $V_R=300V, -di/dt=100A/\mu sec$

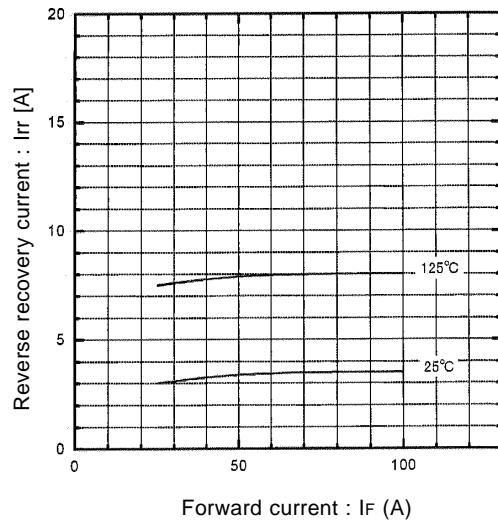

Forward voltage vs. Forward current

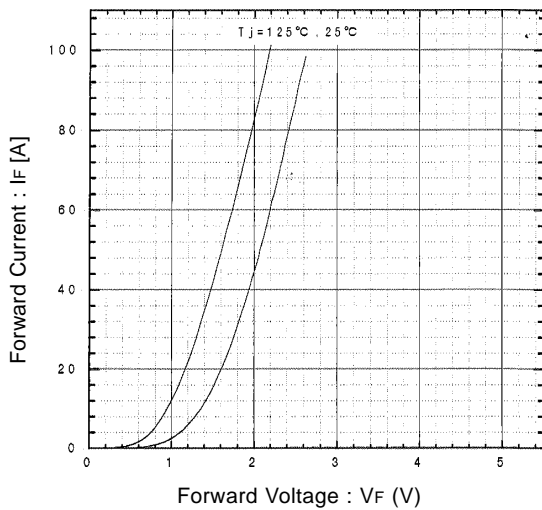

Reverse recovery characteristics vs. $-di/dt$
 $V_R=300V, I_F=50A, T_J=125^\circ C$

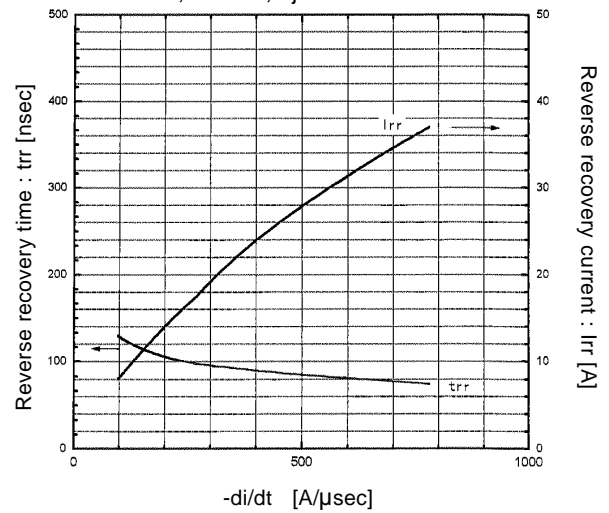

Transient thermal resistance

