

2MBI150NB-120

IGBT Module

1200V / 150A 2 in one-package

■ Features

- High speed switching
- Voltage drive
- Low inductance module structure

■ Applications

- Inverter for Motor drive
- AC and DC Servo drive amplifier
- Uninterruptible power supply
- Industrial machines, such as Welding machines



■ Maximum ratings and characteristics

● Absolute maximum ratings (at $T_c=25^\circ\text{C}$ unless otherwise specified)

| Item | Symbol | Rating | Unit |
|---------------------------|--------------|-----------------|------------------|
| Collector-Emitter voltage | V_{CES} | 1200 | V |
| Gate-Emitter voltage | V_{GES} | ± 20 | V |
| Collector current | Continuous | I_c | 150 A |
| | 1ms | I_c pulse | 300 A |
| | Continuous | $-I_c$ | 150 A |
| | 1ms | $-I_c$ pulse | 300 A |
| Max. power dissipation | P_c | 1100 | W |
| Operating temperature | T_j | +150 | $^\circ\text{C}$ |
| Storage temperature | T_{stg} | -40 to +125 | $^\circ\text{C}$ |
| Isolation voltage | V_{is} | AC 2500 (1min.) | V |
| Screw torque | Mounting *1 | 3.5 | N·m |
| | Terminals *2 | 4.5 | N·m |

*1 : Recommendable value : 2.5 to 3.5 N·m(M5) or (M6)

*2 : Recommendable value : 3.5 to 4.5 N·m(M6)

■ Equivalent Circuit Schematic

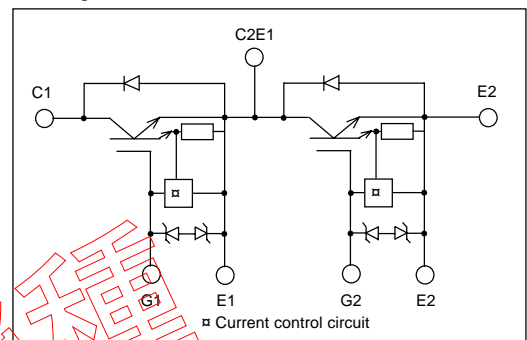

● Electrical characteristics (at $T_j=25^\circ\text{C}$ unless otherwise specified)

| Item | Symbol | Characteristics | | | Conditions | Unit |
|--------------------------------------|---------------|-----------------|-------|------|--|---------------|
| | | Min. | Typ. | Max. | | |
| Zero gate voltage collector current | I_{CES} | — | — | 2.0 | $V_{GE}=0\text{V}$, $V_{CE}=1200\text{V}$ | mA |
| Gate-Emitter leakage current | I_{GES} | — | — | 30 | $V_{CE}=0\text{V}$, $V_{GE}=\pm 20\text{V}$ | μA |
| Gate-Emitter threshold voltage | $V_{GE(th)}$ | 4.5 | — | 7.5 | $V_{CE}=20\text{V}$, $I_c=150\text{mA}$ | V |
| Collector-Emitter saturation voltage | $V_{CE(sat)}$ | — | — | 3.3 | $V_{GE}=15\text{V}$, $I_c=150\text{A}$ | V |
| Input capacitance | C_{ies} | — | 24000 | — | $V_{GE}=0\text{V}$ | pF |
| Output capacitance | C_{oes} | — | 8700 | — | $V_{CE}=10\text{V}$ | |
| Reverse transfer capacitance | C_{res} | — | 7740 | — | $f=1\text{MHz}$ | |
| Turn-on time | t_{on} | — | 0.65 | 1.2 | $V_{CC}=600\text{V}$ | μs |
| | t_r | — | 0.25 | 0.6 | $I_c=150\text{A}$ | |
| Turn-off time | t_{off} | — | 0.85 | 1.5 | $V_{GE}=\pm 15\text{V}$ | μs |
| | t_f | — | 0.35 | 0.5 | $R_G=5.6\text{ ohm}$ | |
| Diode forward on voltage | V_F | — | — | 3.0 | $I_F=150\text{A}$, $V_{GE}=0\text{V}$ | V |
| Reverse recovery time | t_{rr} | — | — | 0.35 | $I_F=150\text{A}$ | μs |

● Thermal resistance characteristics

| Item | Symbol | Characteristics | | | Conditions | Unit |
|--------------------|-----------------|-----------------|-------|------|-------------------------|--------------------|
| | | Min. | Typ. | Max. | | |
| Thermal resistance | $R_{th(j-c)}$ | — | — | 0.11 | IGBT | $^\circ\text{C/W}$ |
| | $R_{th(j-c)}$ | — | — | 0.18 | Diode | $^\circ\text{C/W}$ |
| | $R_{th(c-f)*3}$ | — | 0.025 | — | the base to cooling fin | $^\circ\text{C/W}$ |

*3 : This is the value which is defined mounting on the additional cooling fin with thermal compound

■ Characteristics (Representative)

Collector current vs. Collector-Emitter voltage
T_J=25°C

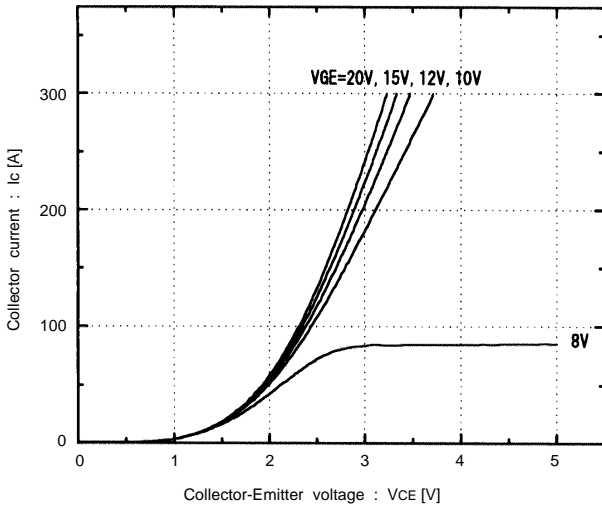

Collector current vs. Collector-Emitter voltage
T_J=125°C

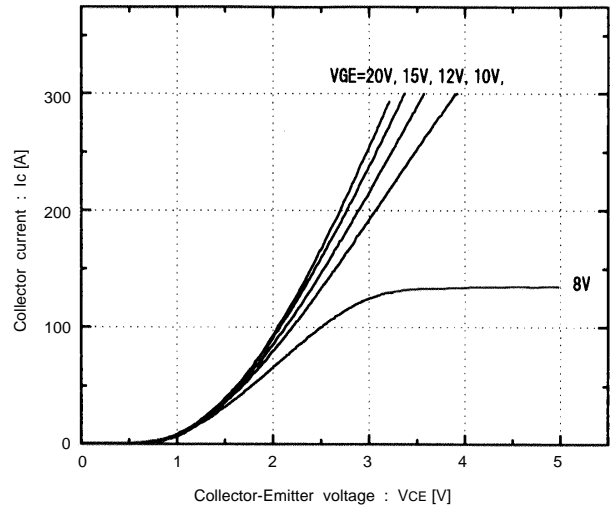

Collector-Emitter vs. Gate-Emitter voltage
T_J=25°C

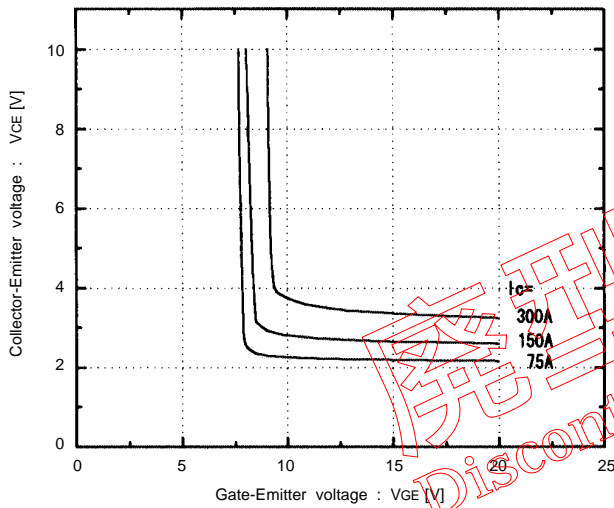

Collector-Emitter vs. Gate-Emitter voltage
T_J=125°C

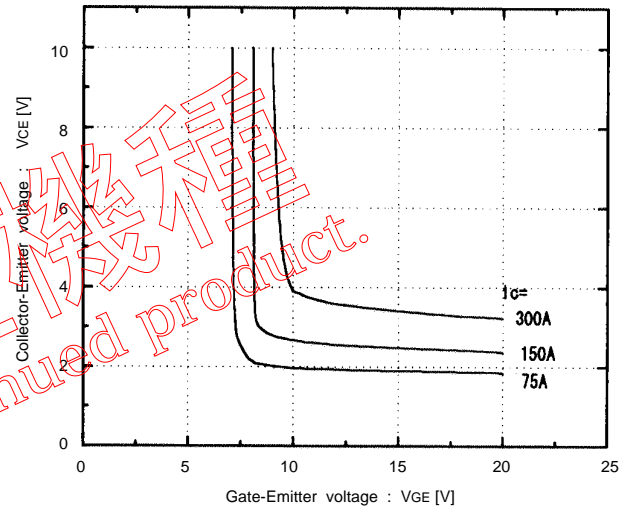

Switching time vs. Collector current
V_{CC}=600V, R_G=5.6 ohm, V_{GE}=±15V, T_J=25°C

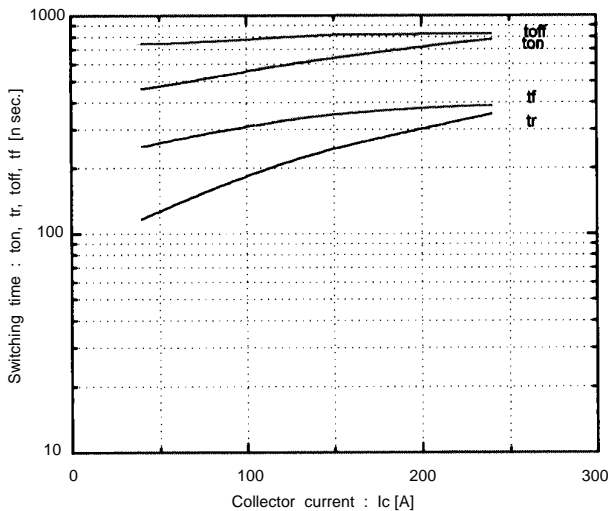

Switching time vs. Collector current
V_{CC}=600V, R_G=5.6 ohm, V_{GE}=±15V, T_J=125°C

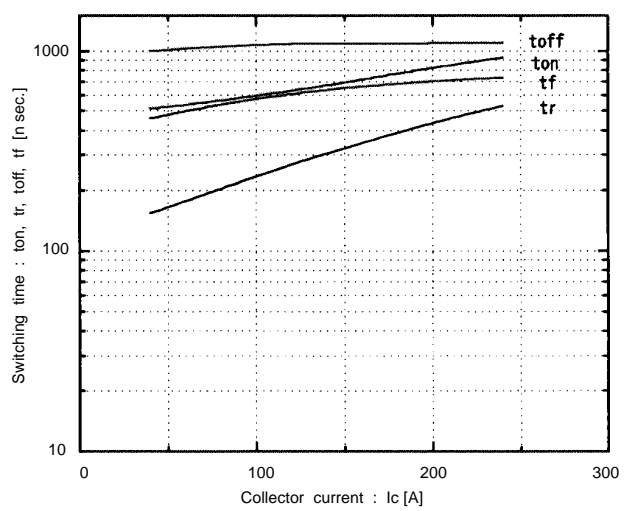

廃止機種
 Discontinued product.

Switching time vs. RG
Vcc=600V, Ic=150A, VGE=±15V, Tj=25°C

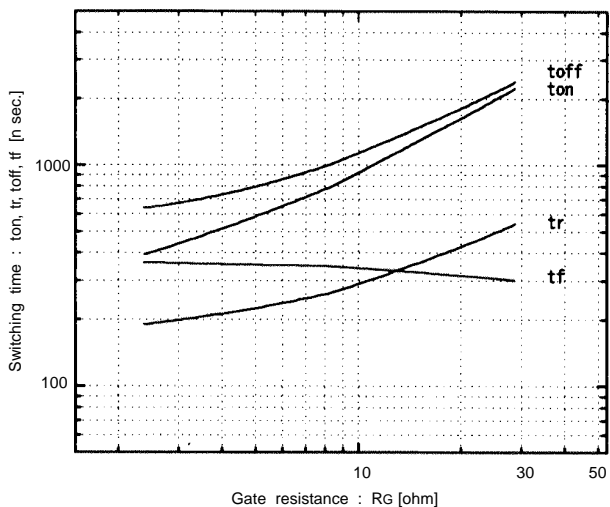

Dynamic input characteristics
Tj=25°C

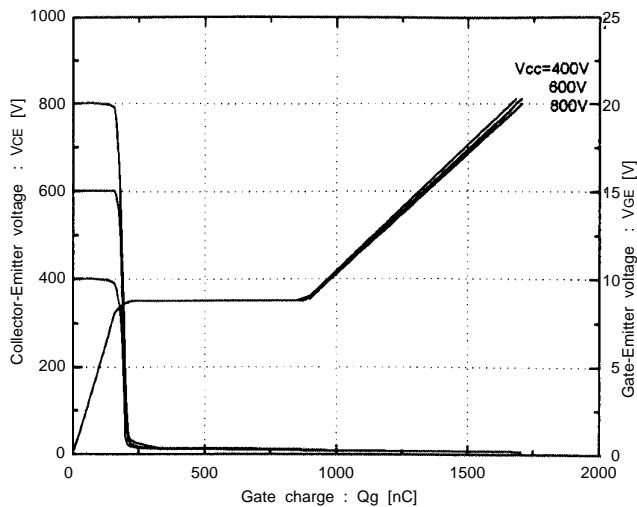

Forward current vs. Forward voltage
VGE=0V

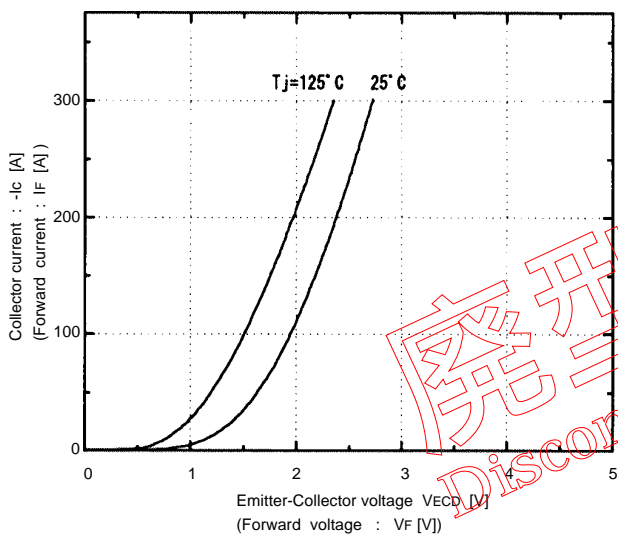

Reverse recovery characteristics
trr, Irr, vs. IF

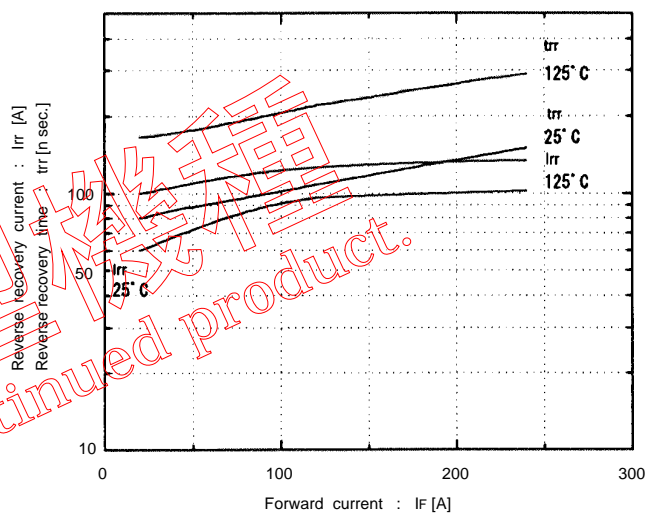

Switching loss vs. Collector current
Vcc=600V, RG=5.6 ohm, VGE=±15V

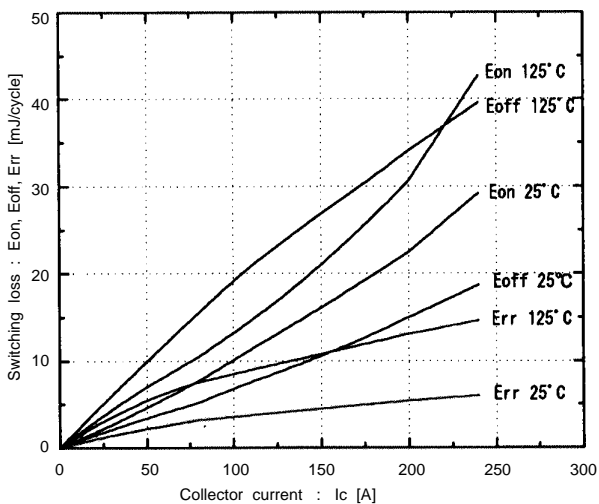

Reversed biased safe operating area
+VGE=15V, -VGE ≤ 15V, Tj ≤ 125°C, RG ≥ 5.6 ohm

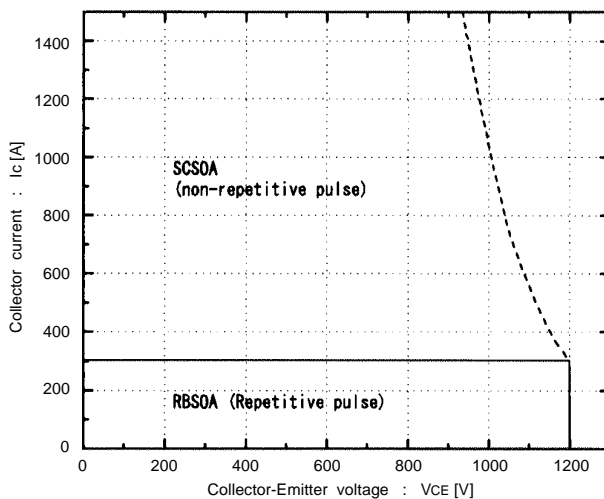

廢品機
 Discontinued product.

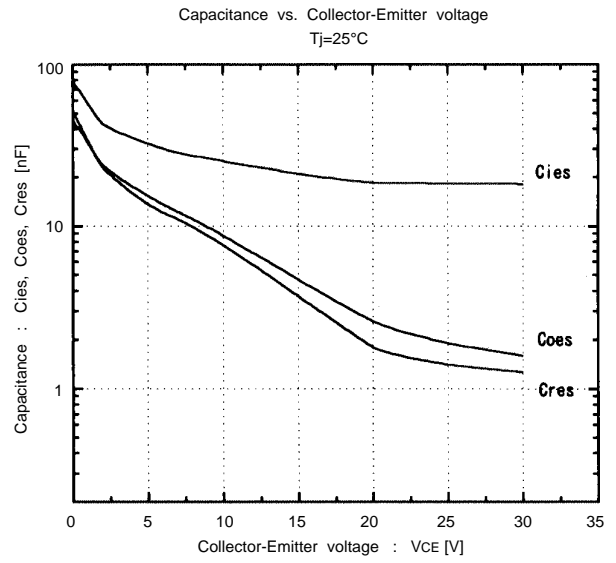
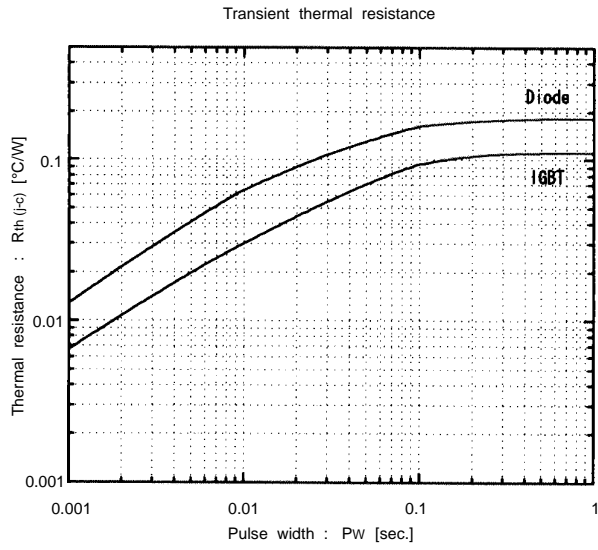

■ Outline Drawings, mm

