

SPECIFICATION

Device Name : IGBT module

Type Name : 2MB1150NT-120A

Spec. No. : **MS5F4143**

This material and the information herein is the property of Fuji Electric Co., Ltd. They shall be neither reproduced, copied, lent, or disclosed in any way whatsoever for the use of any third party nor used for the manufacturing purposes without the express written consent of Fuji Electric Co., Ltd.

Fuji Electric Co., Ltd.
Matsumoto Factory

	DATE	NAME	APPROVED	Fuji Electric Co., Ltd.		
DRAWN	Sep. 19 '97	Y. Kobayashi	T. HOSEN	DWG. NO.	MS5F4143	a
CHECKED	Sep. 19 '97	S. Ogasawara				b
						1/8

Revised Records

Date	Classification	Ind.	Content	Applied date	Drawn	Checked	Approved
Sep. 19. '97	enactment	—	—	Issued date	—	S. Ogawa	T. HOSEN
Sep. 24. '97	Revision	a	Paragraph 10. RG (P5/8)		Y. Kobayashi	S. Ogawa	T. HOSEN
Sep. 21. '98	Revision	b	erase tentative		J. Takahawa	S. Myota	T. HOSEN

This material and the information herein is the property of Fuji Electric Co. Ltd. They shall be neither reproduced, copied, lent, or disclosed in any way whatsoever for the use of any third party nor used for the manufacturing purposes without the express written consent of Fuji Electric Co., Ltd.

Fuji Electric Co., Ltd.

DWG. NO.

MS5F4143

2/8

a
b

2MBI150NT-120A

1. Outline Drawing
Unit : mm

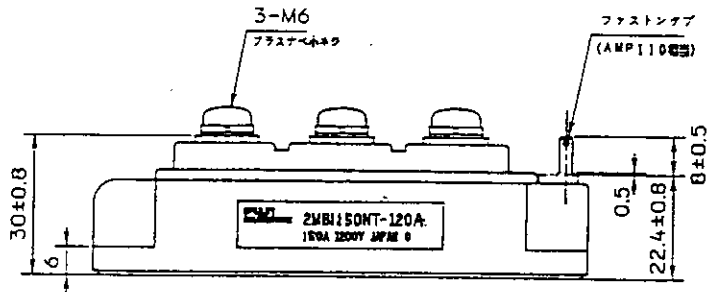
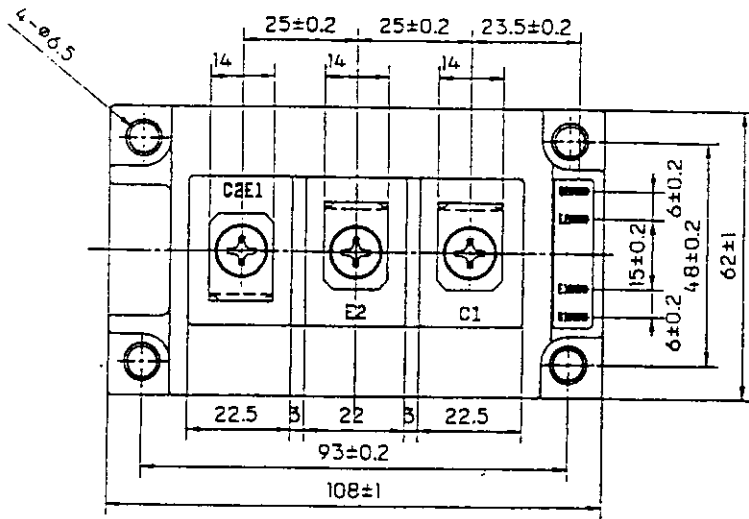

2. Equivalent circuit

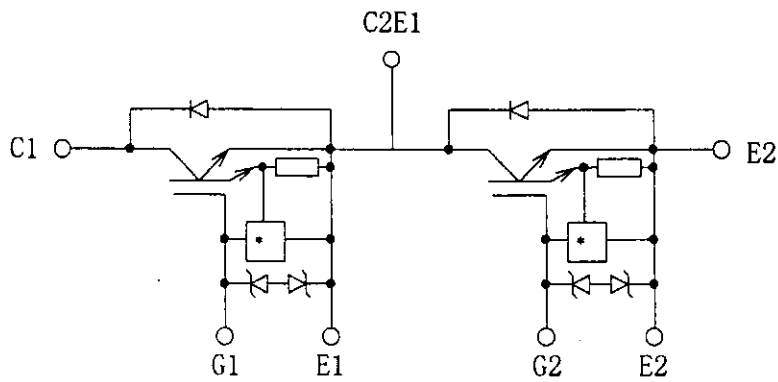

* NLU (Over Current Limiting Circuit)

This material and the information herein is the property of Fuji Electric Co., Ltd. They shall be neither reproduced, copied, lent, or disclosed in any way whatsoever for the use of any third party, nor used for the manufacturing purposes without the express written consent of Fuji Electric Co., Ltd.

3. Absolute Maximum Ratings (at Tc=25°C unless otherwise specified)

Items		Symbols	Ratings	Units
Collector-Emitter voltage		V _{CES}	1200	V
Gate-Emitter voltage		V _{GES}	±20	V
Collector current	Continuous	I _c	150	A
	1ms	I _c pulse	300	
		-I _c	150	
	1ms	-I _c pulse	300	
Max. power dissipation		P _C	1210	W
Operating temperature		T _j	+150	°C
Storage temperature		T _{stg}	-40~+125	°C
Isolation voltage		V _{is}	AC 2500 (1min.)	V
Screw torque		Mounting *1	3.5	N·m
		Terminals *2	4.5	

Note : *1 Recommendable value : 2.5~3.5 N·m (M5) or (M6)

*2 Recommendable value : 3.5~4.5 N·m (M6)

4. Electrical characteristics (at Tj=25°C unless otherwise specified)

Items	Symbols	Characteristics			Conditions	Units
		min.	typ.	max.		
Zero gate voltage Collector current	I _{CES}			2.0	V _{GE} =0V, V _{CE} =1200V	mA
Gate-Emitter leakage current	I _{GES}			30	V _{CE} =0V, V _{GE} =±20V	μA
Gate-Emitter threshold voltage	V _{GE(th)}	4.5		7.5	V _{CE} =20V, I _c =150mA	V
Collector-Emitter saturation voltage	V _{CE(sat)}			3.5	V _{GE} =15V, I _c =150A	V
Input capacitance	C _{ies}		27000		V _{GE} =0V	pF
Output capacitance	C _{oes}		12500		V _{CE} =10V	
Reverse transfer capacitance	C _{res}		10000		f=1MHz	
Turn-on time	t _{on}		0.65	1.2	V _{cc} =600V I _c =150A	μs
	t _r		0.25	0.6		
Turn-off time	t _{off}		0.85	1.5	V _{GE} =±15V R _G =5.6Ω	
	t _f		0.35	0.5		
Diode forward on voltage	V _F			3.4	I _F =150A, V _{GE} =0V	V
Reverse recovery time	t _{rr}			350	I _F =150A	ns
Short-circuit withstand capability	P _w	10			V _{cc} =800V, V _{GE} =+15V R _G =2.7Ω	μs

5. Thermal resistance characteristics

Items	Symbols	Characteristics			Conditions	Units
		min.	typ.	max.		
Thermal resistance	R _{th(j-c)}			0.10	IGBT	°C/W
	R _{th(j-c)}			0.24	Diode	
	※ R _{th(c-f)}		0.025		the base to cooling fin	

※ This is the value which is defined mounting on the additional cooling fin with thermal compound.

6. Indication on module (モジュール表示)

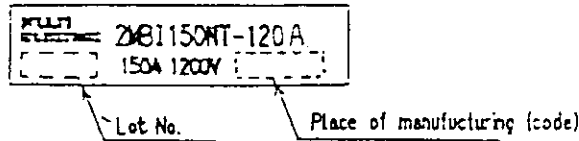

7. Applicable category (適用範囲)

This specification is applied to IGBT module named 2MBI150NT-120A.
 本納入仕様書は、IGBTモジュール 2MBI150NT-120A に適用する。

8. Storage and transportation notes (保管、運搬上の注意事項)

- The IGBT module should be stored at a standard temperature of 5 to 35°C and humidity of 45 to 75%.
 常温保存が望ましい。(5~35°C、45~75%)
- Store modules in a place with few temperature changes in order to avoid condensation on the module surface.
 急激な温度変化の無きこと。(モジュール表面が結露しないこと)
- Avoid exposure to corrosive gases and dust.
 腐蝕性ガスの発生場所、塵埃の多い場所は避けること。
- Avoid excessive external force on the module.
 製品に荷重がかからないように十分注意すること。
- Store modules with unprocessed terminals.
 モジュールの端子は未加工の状態での保管すること。
- Do not drop or otherwise shock the modules when transporting.
 製品の運搬時に衝撃を与えたり、落下させたりしないこと。

9. Heat sink mounting notes (ヒートシンク取り付け上の注意事項)

- The mounting surface of the heat sink should be finished to a roughness of 10µm or less and a warp between screw holes of 100µm or less.
 本モジュールを取り付ける冷却体の取付面の仕上げは、粗さ10µm以下、取付ネジ間で平坦度100µm以下とする。
- Each mounting screw should be fastened using a specified torque after pre-fastening using a 1/3 specified torque.
 取付けネジは、規定の1/3のトルクで仮締を行った後、規定のトルクで本締を行って下さい。
- If the above notes are not met, it has a possibility to break the insulation between the IGBT module's chips and metal base.
 上記注意事項の範囲外で御適用した場合、IGBTモジュールのチップと金属ベース間の絶縁破壊を生ずる可能性があります。

10. Reverse gate bias voltage (ゲート逆バイアス)

- Recommendable value of the reverse gate bias voltage : -7V(typ.), -5V(min.), $RG=5.6\Omega$.
 ゲート逆バイアスの推奨値 : -7V(typ.), -5V(min.), $RG=5.6\Omega$
- The reverse gate bias voltage means the voltage between the gate terminal and the auxiliary emitter terminal of the module.
 ゲート逆バイアス電圧は、モジュールのゲート端子と補助エミッタ端子間の電圧である。

This material and the information herein is the property of Fuji Electric Co., Ltd. They shall be neither reproduced, copied, lent, or disclosed in any way whatsoever for the use of any third party, nor used for the manufacturing purposes without the express written consent of Fuji Electric Co., Ltd.

11. Setting dead-time (デッドタイムの設定)

- Recommendable value of the dead-time : $3\mu\text{s}$ (min)
- デッドタイムの推奨値 : $3\mu\text{s}$ (min)

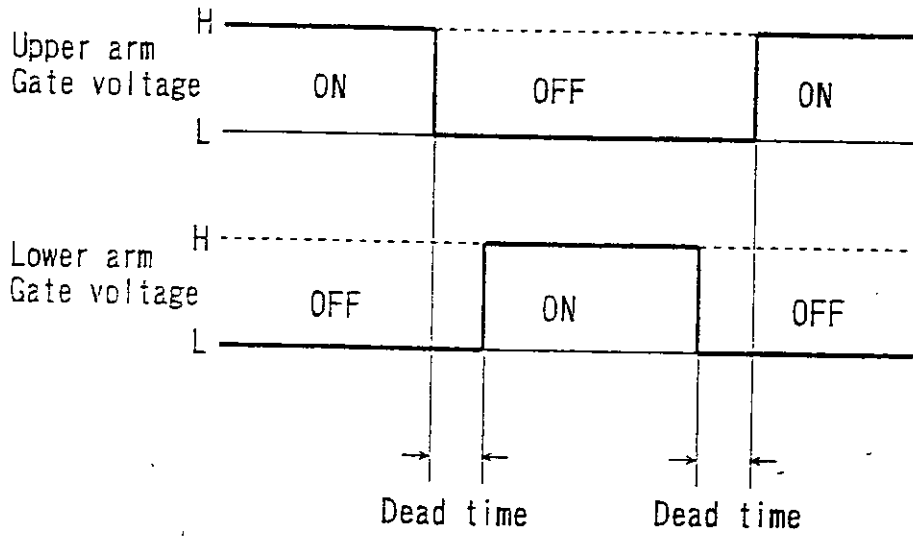
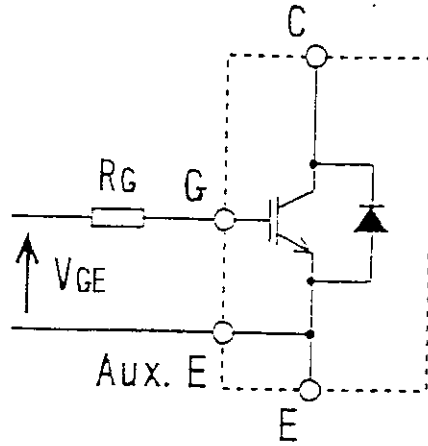

Dead time timing chart

This material and the information herein is the property of Fuji Electric Co., Ltd. They shall be neither reproduced, copied, lent, or disclosed in any way whatsoever for the use of any third party nor used for the manufacturing purposes without the express written consent of Fuji Electric Co., Ltd.

This material and the information herein is the property of Fuji Electric Co., Ltd. They shall be neither reproduced, copied, lent, or disclosed in any way whatsoever for the use of any third party, nor used for the manufacturing purposes without the express written consent of Fuji Electric Co., Ltd.

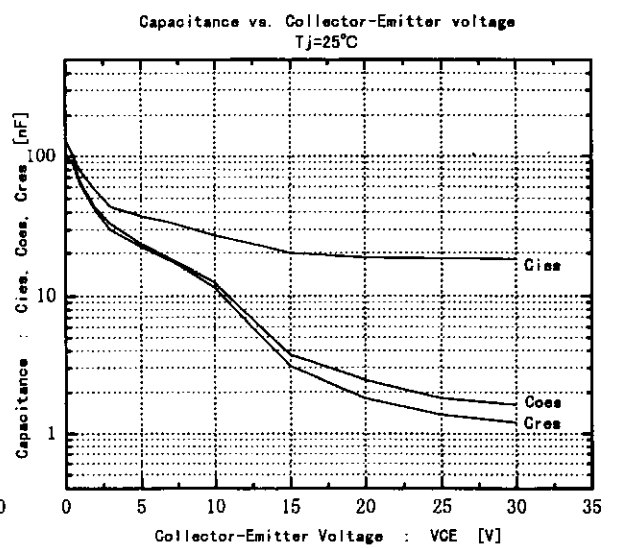
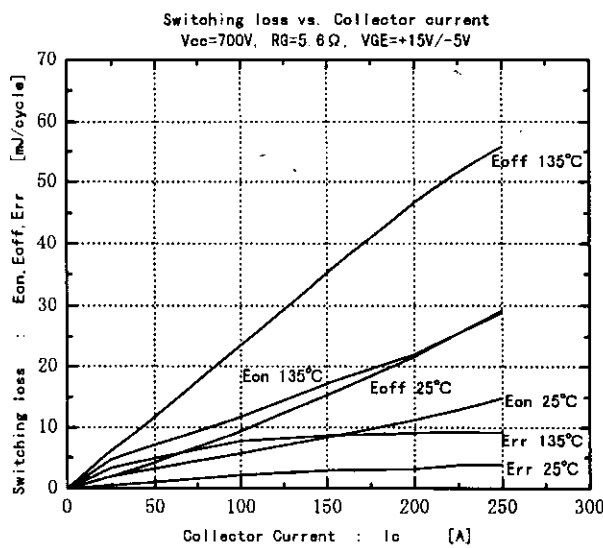
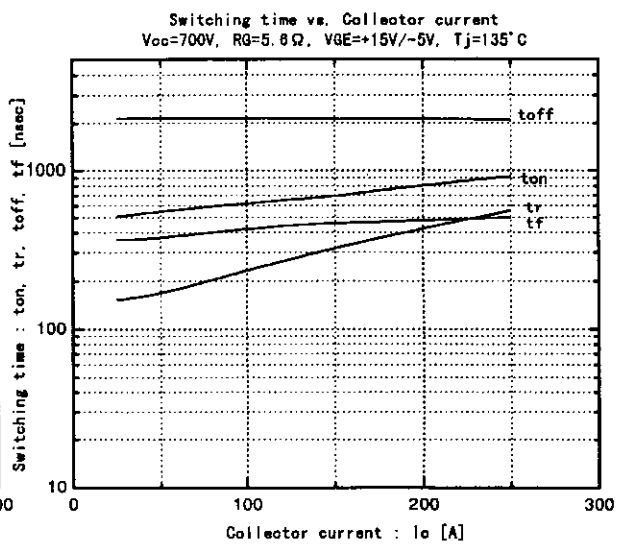
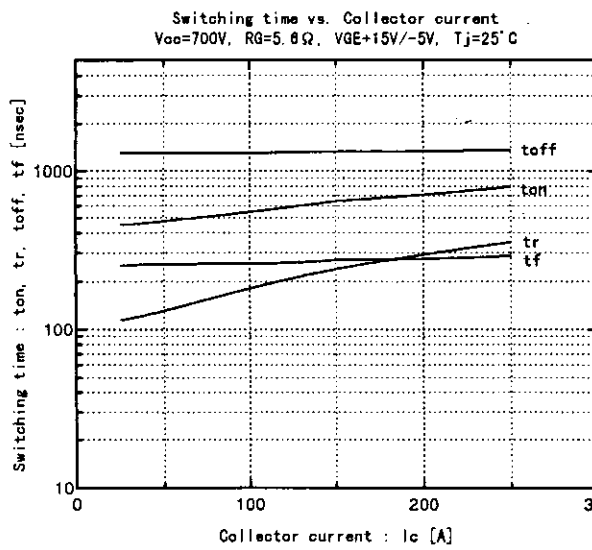
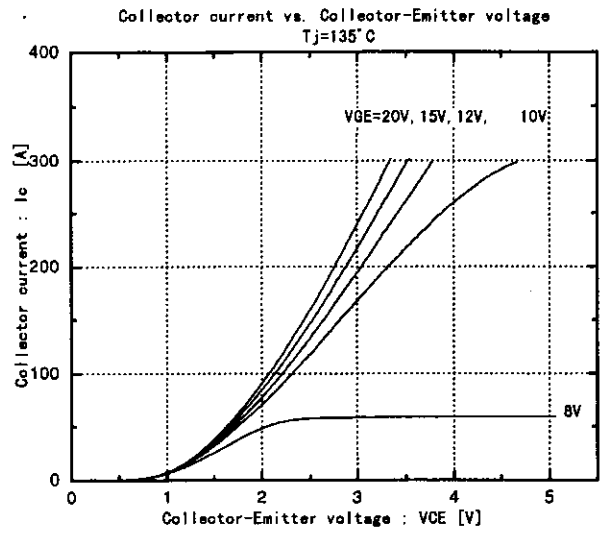
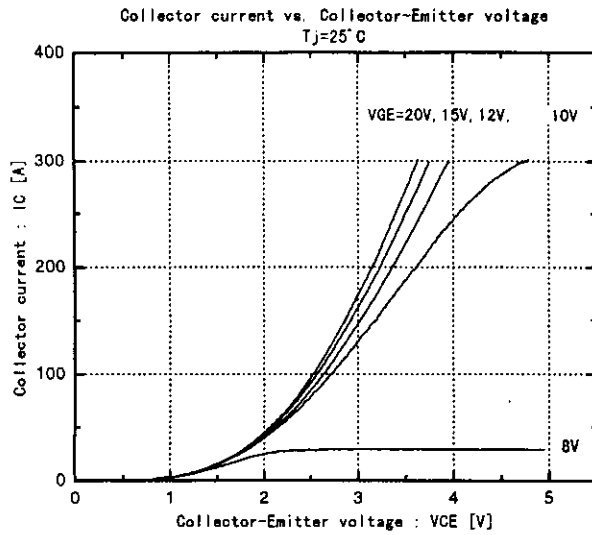

This material and the information herein is the property of Fuji Electric Co., Ltd. They shall be neither reproduced, copied, lent, or disclosed in any way whatsoever for the use of any third party, nor used for the manufacturing purposes without the express written consent of Fuji Electric Co., Ltd.

Switching time vs. R_G
 $V_{CC}=700V, I_c=150A, V_{GE}=+15V/-5V, T_j=25^\circ C$

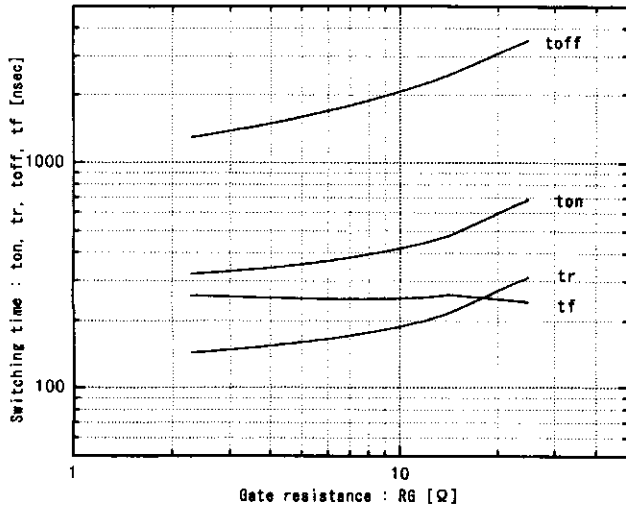

Dynamic input characteristics
 $T_j=25^\circ C$

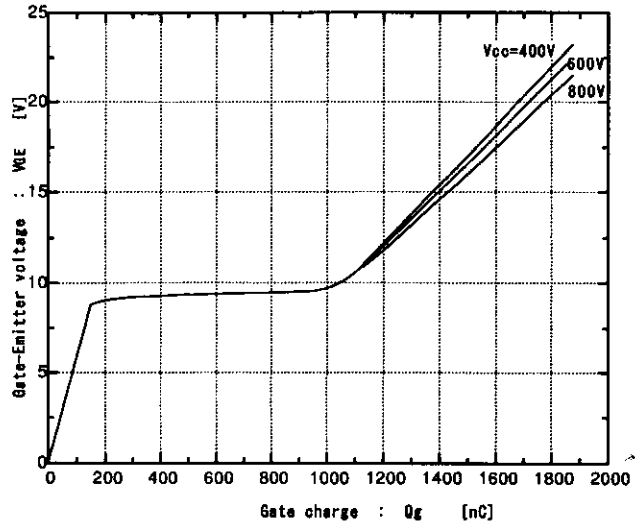

Forward current vs. Forward voltage
 $V_{GE}=0V$

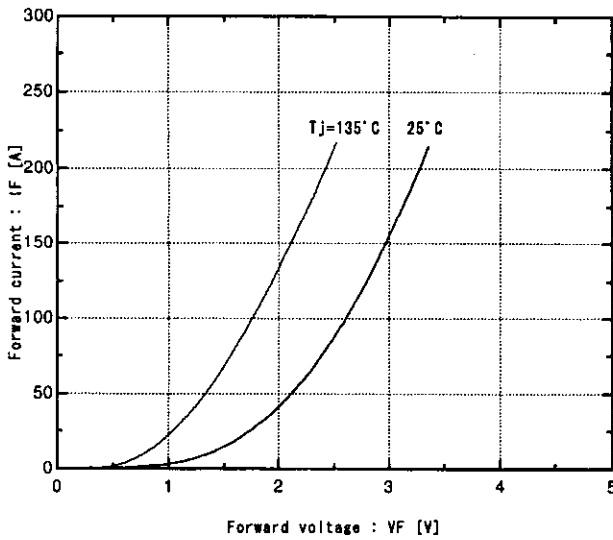

Reverse recovery characteristics
 t_{rr}, I_{rr} vs. I_F

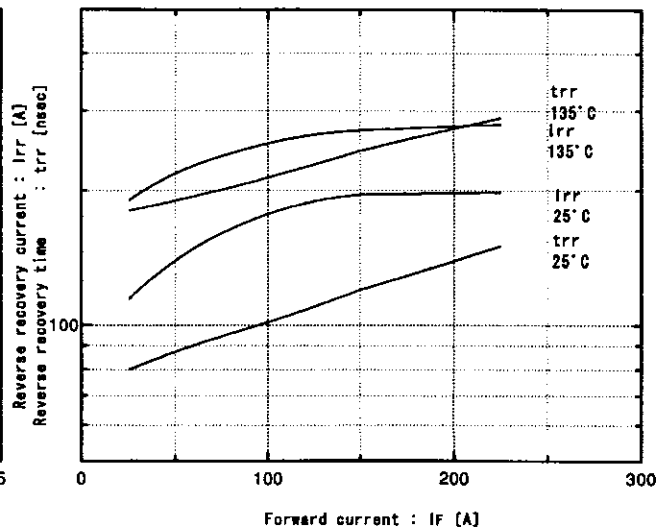

Transient thermal resistance

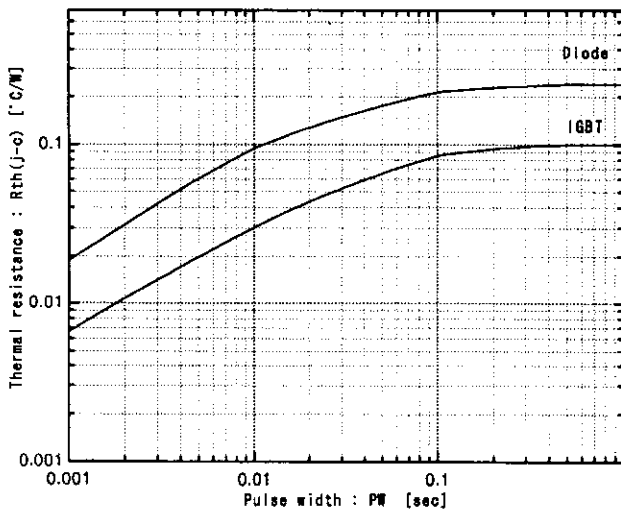

Reversed biased safe operating area
 $+V_{GE}=15V, -V_{GE}\leq 15V, T_j\leq 135^\circ C$

