

2MBI200HJ-120-50

IGBT Modules

Power Module (V series)
1200V / 200A / 2-in-1 package

■ **Features**

- High speed switching
- Voltage drive
- Low Inductance module structure

■ **Applications**

- Soft-switching Application
- Industrial machines, such as Welding machines

■ **Outline drawing (Unit : mm)**

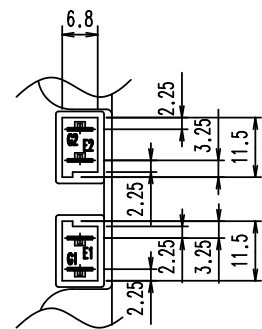
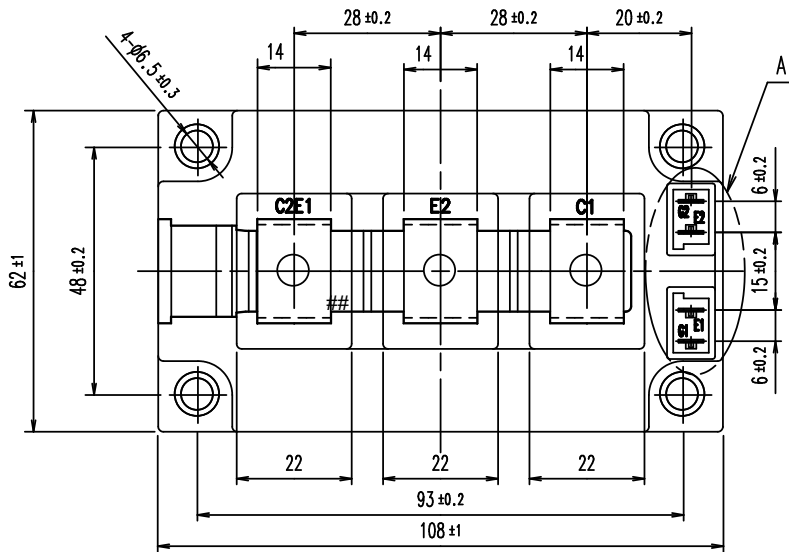

DETAIL A

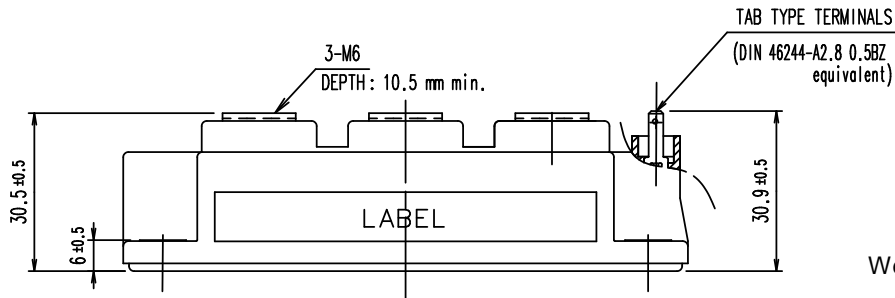

Weight: 370g (typ.)

■ **Equivalent Circuit**

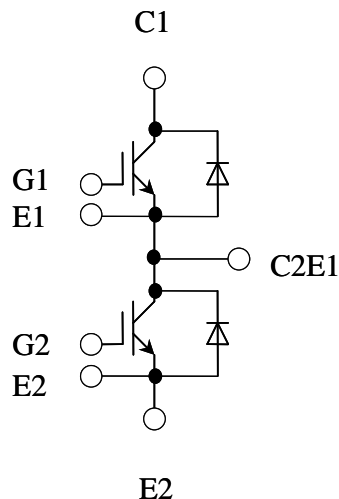

2MBI200HJ-120-50

IGBT Modules
■ Absolute Maximum Ratings (at $T_C = 25^\circ\text{C}$ unless otherwise specified)

Items		Symbols	Conditions	Maximum Ratings	Units	
Collector-Emitter voltage		V_{CES}		1200	V	
Gate-Emitter voltage		V_{GES}		± 20	V	
Collector current	I_C		Continuous	$T_C = 80^\circ\text{C}$	200	A
				$T_C = 25^\circ\text{C}$	275	
	I_C pulse	1ms		400		
	$-I_C$			400		
		$-I_C$ pulse	1ms		800	
Collector power dissipation		P_C	1 device	1385	W	
Junction temperature		T_j		150	°C	
Case temperature		T_C		125		
Storage temperature		T_{stg}		-40 ~ 125		
Isolation voltage	between terminal and copper base (*1)	V_{iso}	AC: 1min.	2500	VAC	
Screw Torque	Mounting (*2)	-		6.0	N m	
	Terminals (*3)	-		5.0		

(*1) All terminals should be connected together during the test.

(*2) Recommendable Value : 3.0-6.0 Nm (M5 or M6)

(*3) Recommendable Value : 2.5-5.0 Nm (M6)

2MBI200HJ-120-50

IGBT Modules
■ Electrical characteristics (at $T_j=25^\circ\text{C}$ unless otherwise specified)

Items	Symbols	Conditions	Characteristics			Units	
			min.	typ.	max.		
Zero gate voltage Collector current	I_{CES}	$V_{GE}=0V, V_{CE}=1200V$	-	-	4.0	mA	
Gate-Emitter leakage current	I_{GES}	$V_{CE}=0V, V_{GE}=\pm 20V$	-	-	800	nA	
Gate-Emitter threshold voltage	$V_{GE(th)}$	$V_{CE}=20V, I_c=200mA$	5.7	6.2	6.7	V	
Collector-Emitter saturation voltage	$V_{CE(sat)}$ (terminal)	$V_{GE}=15V, I_c=200A$	$T_j=25^\circ\text{C}$	-	3.60	3.90	V
			$T_j=125^\circ\text{C}$	-	4.50	-	
	$V_{CE(sat)}$ (chip)	$V_{GE}=15V, I_c=200A$	$T_j=25^\circ\text{C}$	-	3.20	3.50	
			$T_j=125^\circ\text{C}$	-	4.10	-	
Internal gate resistance	$R_{G(int)}$	-	-	0.8	-	Ω	
Input capacitance	C_{ies}	$V_{CE}=10V, V_{GE}=0V, f=1MHz$	-	15.2	-	nF	
Turn-on time	t_{on}	$V_{CC}=600V, I_c=200A$ $V_{GE}=\pm 15V, R_G=4.7\Omega$ $T_j=125^\circ\text{C}, L_s=30nH$	-	250	-	nsec	
	t_r		-	180	-		
	$t_{r(l)}$		-	40	-		
Turn-off time	t_{off}		-	300	-		
	t_f		-	50	-		
Forward on voltage	V_F (terminal)		$V_{GE}=0V, I_F=300A$	$T_j=25^\circ\text{C}$	-	2.15	2.40
		$T_j=125^\circ\text{C}$		-	2.30	-	
	V_F (chip)	$V_{GE}=0V, I_F=300A$	$T_j=25^\circ\text{C}$	-	1.70	1.95	
			$T_j=125^\circ\text{C}$	-	1.85	-	
Reverse recovery time	t_{rr}	$I_F=200A$	-	130	-	nsec	

5. Thermal resistance characteristics

Items	Symbols	Conditions	Characteristics			Units
			min.	typ.	max.	
Thermal resistance (1device)	$R_{th(j-c)}$	IGBT	-	-	0.090	$^\circ\text{C/W}$
		FWD	-	-	0.140	
Contact thermal resistance (1device) (*1)	$R_{th(c-f)}$	with thermal compound	-	0.0125	-	

(*1) This is the value which is defined mounting on the additional cooling fin with thermal compound.

2MBI200HJ-120-50

IGBT Modules

Collector current vs. Collector-Emitter voltage
 $T_j = 25^\circ\text{C}$ / chip

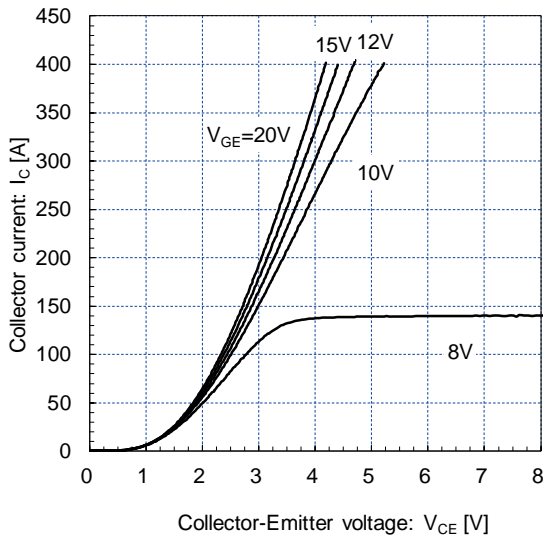

Collector current vs. Collector-Emitter voltage (typ.)
 $T_j = 125^\circ\text{C}$ / chip

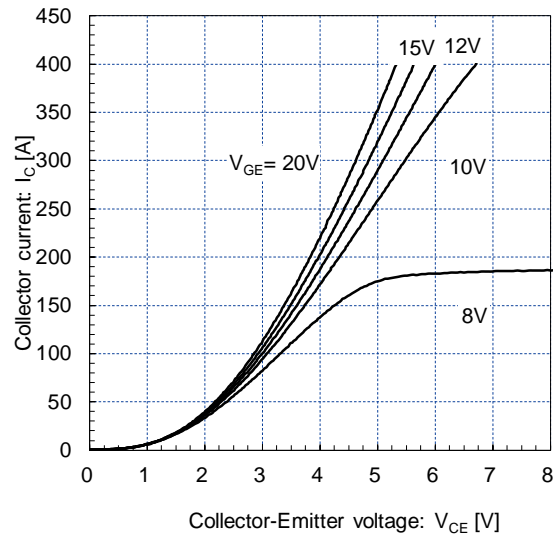

Collector current vs. Collector-Emitter voltage
 $V_{GE} = 15\text{V}$ / chip

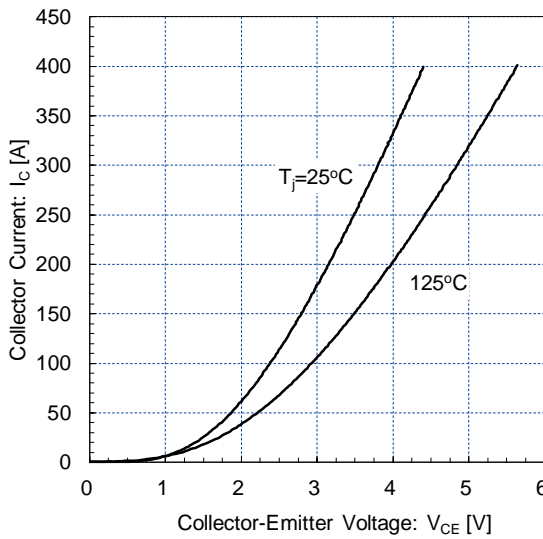

Collector-Emitter voltage vs. Gate-Emitter voltage
 $T_j = 25^\circ\text{C}$ / chip

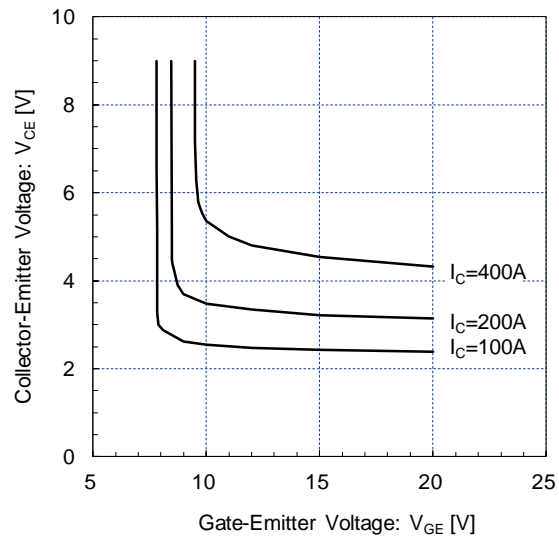

Capacitance vs. Collector-Emitter Voltage
 $V_{GE} = 0\text{V}$, $f = 1\text{MHz}$, $T_j = 25^\circ\text{C}$

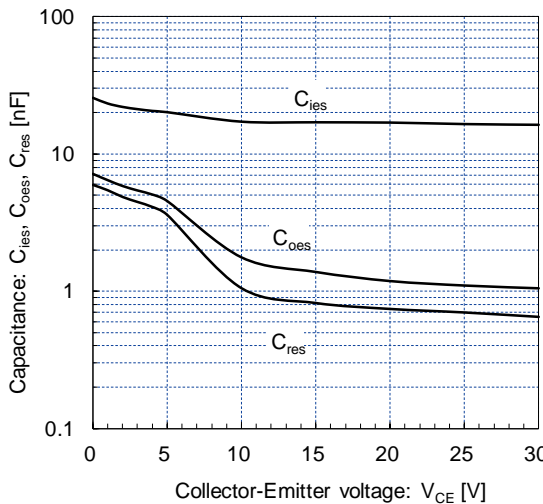

Dynamic Gate Charge (typ.)
 $V_{CC} = 600\text{V}$, $I_C = 200\text{A}$, $T_j = 25^\circ\text{C}$

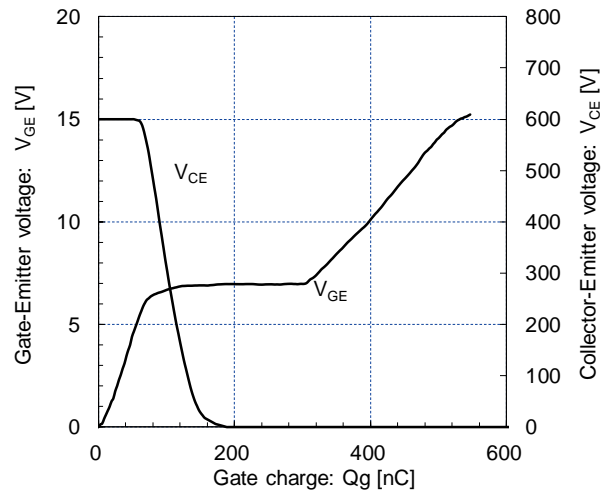

2MBI200HJ-120-50

IGBT Modules

Switching time vs. Collector current (typ.)
 $V_{CC}=600V, V_{GE}=\pm 15V, R_g=4.7\Omega, T_j=25^\circ C$

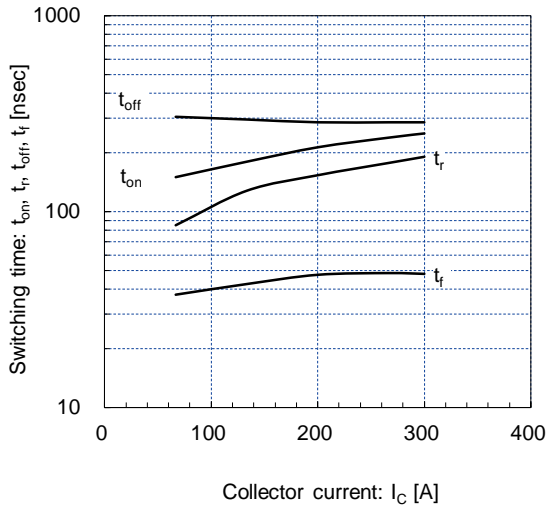

Switching time vs. Collector current (typ.)
 $V_{CC}=600V, V_{GE}=\pm 15V, R_g=4.7\Omega, T_j=125^\circ C$

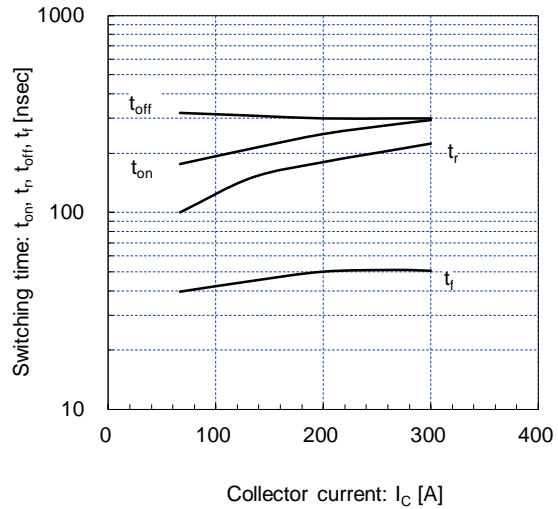

Switching time vs. Gate resistance (typ.)
 $V_{CC}=600V, I_C=200A, V_{GE}=\pm 15V, T_j=125^\circ C$

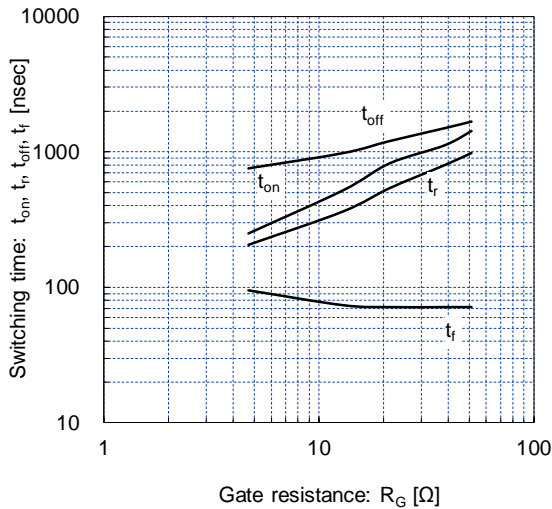

Switching loss vs. Collector current (typ.)
 $V_{CC}=600V, V_{GE}=\pm 15V, R_g=4.7\Omega, T_j=25, 125^\circ C$

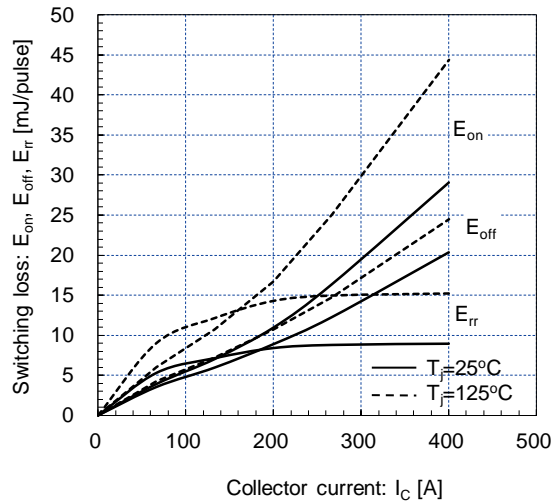

Switching loss vs. Gate resistance (typ.)
 $V_{CC}=600V, I_C=200A, V_{GE}=\pm 15V, T_j=25, 125^\circ C$

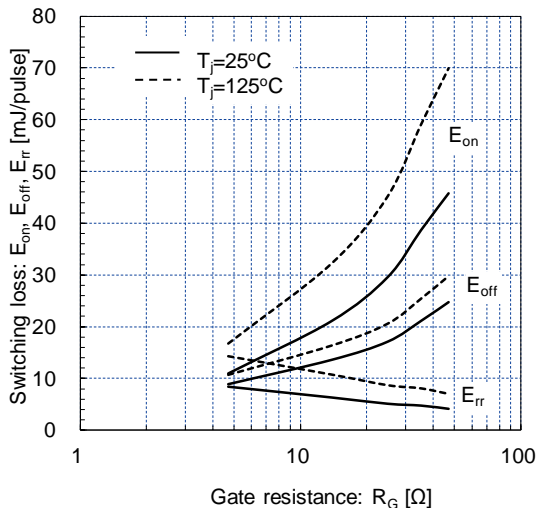

Reverse bias safe operating area (max.)
 $+V_{GE}=15V, -V_{GE}=15V, R_g=4.7\Omega, T_j=125^\circ C$

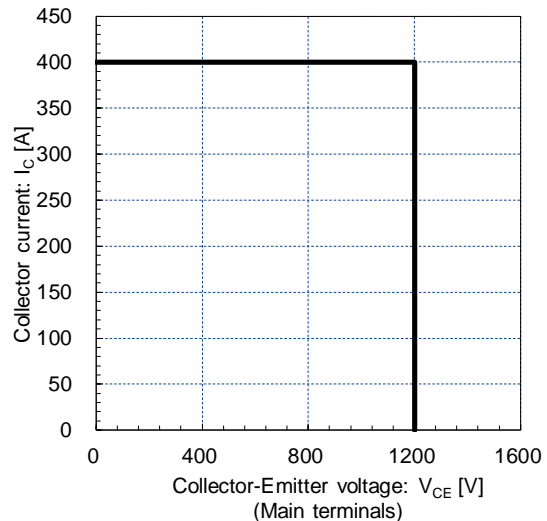

2MBI200HJ-120-50

IGBT Modules

Forward current vs. Forward voltage (typ.)
chip

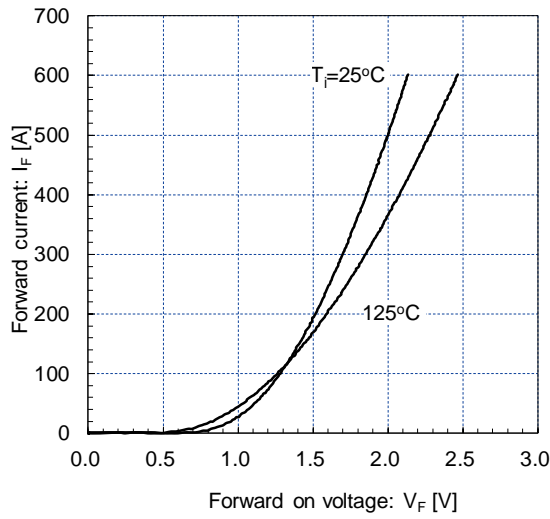

Reverse recovery characteristics (typ.)
V_{cc}=600V, V_{GE}=±15V, R_g=4.7Ω, T_J=125°C

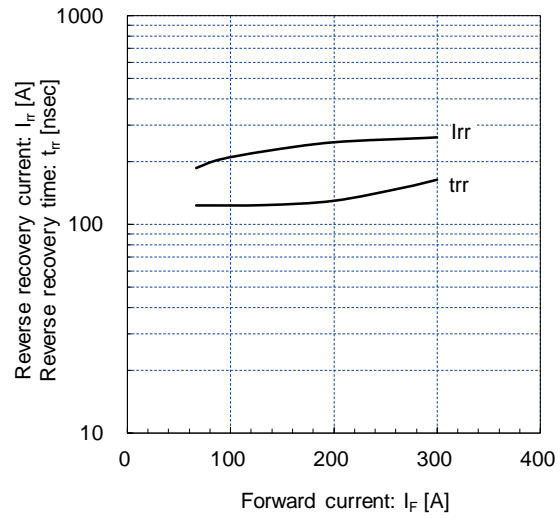

Transient thermal resistance (max.)

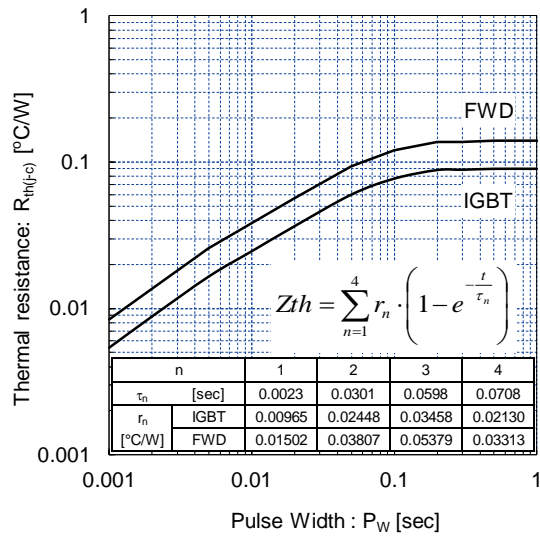

FWD safe operating area (max.)
T_J = 125°C

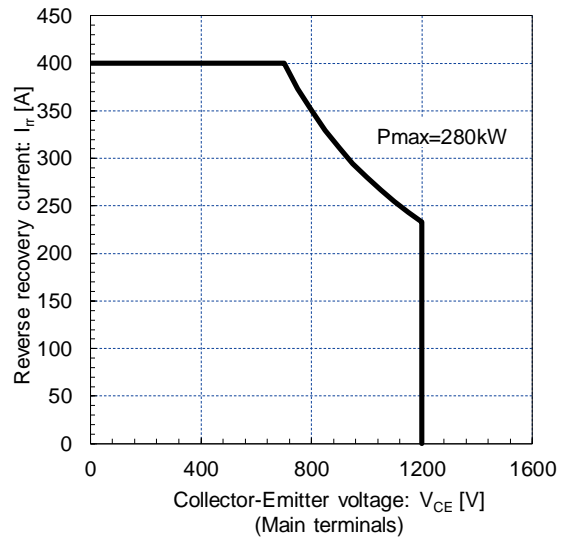

Warnings

1. This Catalog contains the product specifications, characteristics, data, materials, and structures as of 8/2014 .
The contents are subject to change without notice for specification changes or other reasons. When using a product listed in this Catalog, be sure to obtain the latest specifications.

2. All applications described in this Catalog exemplify the use of Fuji's products for your reference only. No right or license, either express or implied, under any patent, copyright, trade secret or other intellectual property right owned by Fuji Electric Co., Ltd. is (or shall be deemed) granted. Fuji Electric Co., Ltd. makes no representation or warranty, whether express or implied, relating to the infringement or alleged infringement of other's intellectual property rights which may arise from the use of the applications described herein.

3. Although Fuji Electric Co., Ltd. is enhancing product quality and reliability, a small percentage of semiconductor products may become faulty. When using Fuji Electric semiconductor products in your equipment, you are requested to take adequate safety measures to prevent the equipment from causing a physical injury, fire, or other problem if any of the products become faulty. It is recommended to make your design fail-safe, flame retardant, and free of malfunction.

4. The products introduced in this Catalog are intended for use in the following electronic and electrical equipment which has normal reliability requirements.
 - Computers · OA equipment · Communications equipment (terminal devices) · Measurement equipment
 - Machine tools · Audiovisual equipment · Electrical home appliances · Personal equipment · Industrial robots etc.

5. If you need to use a product in this Catalog for equipment requiring higher reliability than normal, such as for the equipment listed below, it is imperative to contact Fuji Electric Co., Ltd. to obtain prior approval. When using these products for such equipment, take adequate measures such as a backup system to prevent the equipment from malfunctioning even if a Fuji's product incorporated in the equipment becomes faulty.
 - Transportation equipment (mounted on cars and ships) · Trunk communications equipment
 - Traffic-signal control equipment · Gas leakage detectors with an auto-shut-off feature
 - Emergency equipment for responding to disasters and anti-burglary devices · Safety devices · Medical equipment

6. Do not use products in this Catalog for the equipment requiring strict reliability such as the following and equivalents to strategic equipment (without limitation).
 - Space equipment · Aeronautic equipment · Nuclear control equipment · Submarine repeater equipment

7. Copyright (c)1996-2014 by Fuji Electric Co., Ltd. All rights reserved.
No part of this Catalog may be reproduced in any form or by any means without the express permission of Fuji Electric Co., Ltd.

8. If you have any question about any portion in this Catalog, ask Fuji Electric Co., Ltd. or its sales agents before using the product. Neither Fuji Electric Co., Ltd. nor its agents shall be liable for any injury caused by any use of the products not in accordance with instructions set forth herein.

Technical Information

IGBT Modules

- Please refer to URLs below for further information about products, application manuals and technical documents.
- 关于本规格书中没有记载的产品信息·应用手册·技术资料等·请参考以下链接。
- 本データシートに記載されていない製品情報，アプリケーションマニュアル，技術資料は以下の URL をご参照下さい。

FUJI ELECTRIC Power Semiconductor WEB site

日本	www.fujielectric.co.jp/products/semiconductor/
Global	www.fujielectric.com/products/semiconductor/
中国	www.fujielectric.com.cn/products/semiconductor/
Europe	www.fujielectric-europe.com/components/semiconductors/
North America	www.americas.fujielectric.com/components/semiconductors/

Information

日本

1 半導体総合カタログ	www.fujielectric.co.jp/products/semiconductor/catalog/
2 製品情報	www.fujielectric.co.jp/products/semiconductor/model/
3 アプリケーションマニュアル	www.fujielectric.co.jp/products/semiconductor/model/igbt/application/
4 技術資料	www.fujielectric.co.jp/products/semiconductor/model/igbt/technical/
5 マウンティングインストラクション	www.fujielectric.co.jp/products/semiconductor/model/igbt/mounting/
6 IGBT 損失シミュレーションソフト	www.fujielectric.co.jp/products/semiconductor/model/igbt/simulation/
7 AT-NPC 3-Level 損失シミュレーションソフト	www.fujielectric.co.jp/products/semiconductor/model/igbt/simulation_3level/
8 富士電機技報	www.fujielectric.co.jp/products/semiconductor/journal/
9 製品のお問い合わせ	www.fujielectric.co.jp/products/semiconductor/contact/
10 改廃のお知らせ	www.fujielectric.co.jp/products/semiconductor/discontinued/

Global

1 Semiconductors General Catalog	www.fujielectric.com/products/semiconductor/catalog/
2 Product Information	www.fujielectric.com/products/semiconductor/model/
3 Application Manuals	www.fujielectric.com/products/semiconductor/model/igbt/application/
4 Technical Documents	www.fujielectric.com/products/semiconductor/model/igbt/technical/
5 Mounting Instructions	www.fujielectric.com/products/semiconductor/model/igbt/mounting/
6 IGBT Loss Simulation Software	www.fujielectric.com/products/semiconductor/model/igbt/simulation/
7 AT-NPC 3-Level Loss Simulation Software	www.fujielectric.com/products/semiconductor/model/igbt/simulation_3level/
8 Fuji Electric Journal	www.fujielectric.com/products/semiconductor/journal/
9 Contact	www.fujielectric.com/products/semiconductor/contact/
10 Revised and discontinued product information	www.fujielectric.com/products/semiconductor/discontinued/

中国

1 半导体综合目录	www.fujielectric.com.cn/products/semiconductor/catalog/
2 产品信息	www.fujielectric.com.cn/products/semiconductor/model/
3 应用手册	www.fujielectric.com.cn/products/semiconductor/model/igbt/application/
4 技术资料	www.fujielectric.com.cn/products/semiconductor/model/igbt/technical/
5 安装说明书	www.fujielectric.com.cn/products/semiconductor/model/igbt/mounting/
6 IGBT 损耗模拟软件	www.fujielectric.com.cn/products/semiconductor/model/igbt/simulation/
7 AT-NPC 3-Level 损耗模拟软件	www.fujielectric.com.cn/products/semiconductor/model/igbt/simulation_3level/
8 富士电机技报	www.fujielectric.com.cn/products/semiconductor/journal/
9 产品咨询	www.fujielectric.com.cn/products/semiconductor/contact/
10 产品更改和停产信息	www.fujielectric.com.cn/products/semiconductor/discontinued/