

# 2MBI200N-060

IGBT Module

## 600V / 200A 2 in one-package

### ■ Features

- High speed switching
- Voltage drive
- Low inductance module structure

### ■ Applications

- Inverter for Motor drive
- AC and DC Servo drive amplifier
- Uninterruptible power supply
- Industrial machines, such as Welding machines



### ■ Maximum ratings and characteristics

#### ● Absolute maximum ratings (at Tc=25°C unless otherwise specified)

Item	Symbol	Rating	Unit
Collector-Emitter voltage	V <sub>CEs</sub>	600	V
Gate-Emitter voltage	V <sub>GES</sub>	±20	V
Collector current	Continuous	I <sub>c</sub>	200 A
	1ms	I <sub>c</sub> pulse	400 A
	Continuous	-I <sub>c</sub>	200 A
	1ms	-I <sub>c</sub> pulse	400 A
Max. power dissipation	P <sub>c</sub>	780	W
Operating temperature	T <sub>j</sub>	+150	°C
Storage temperature	T <sub>stg</sub>	-40 to +125	°C
Isolation voltage	V <sub>is</sub>	AC 2500 (1min.)	V
Screw torque	Mounting *1	3.5	N·m
	Terminals *1	3.5	N·m

\*1 : Recommendable value : 2.5 to 3.5 N·m(M5)

#### ■ Equivalent Circuit Schematic

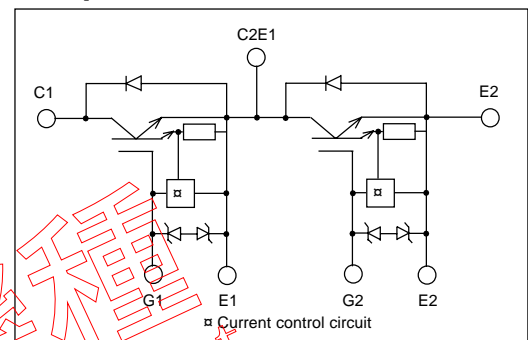

#### ● Electrical characteristics (at Tj=25°C unless otherwise specified)

Item	Symbol	Characteristics			Conditions	Unit
		Min.	Typ.	Max.		
Zero gate voltage collector current	I <sub>CEs</sub>	–	–	2.0	V <sub>GE</sub> =0V, V <sub>CE</sub> =600V	mA
Gate-Emitter leakage current	I <sub>GES</sub>	–	–	30	V <sub>CE</sub> =0V, V <sub>GE</sub> =±20V	μA
Gate-Emitter threshold voltage	V <sub>GE(th)</sub>	4.5	–	7.5	V <sub>CE</sub> =20V, I <sub>c</sub> =200mA	V
Collector-Emitter saturation voltage	V <sub>CE(sat)</sub>	–	–	2.8	V <sub>GE</sub> =15V, I <sub>c</sub> =200A	V
Input capacitance	C <sub>ies</sub>	–	13200	–	V <sub>GE</sub> =0V	pF
Output capacitance	C <sub>oes</sub>	–	2930	–	V <sub>CE</sub> =10V	
Reverse transfer capacitance	C <sub>res</sub>	–	1330	–	f=1MHz	
Turn-on time	t <sub>on</sub>	–	0.6	1.2	V <sub>CC</sub> =300V	μs
	t <sub>r</sub>	–	0.2	0.6	I <sub>c</sub> =200A	
Turn-off time	t <sub>off</sub>	–	0.6	1.0	V <sub>GE</sub> =±15V	μs
	t <sub>f</sub>	–	0.2	0.35	R <sub>G</sub> =9.1 ohm	
Diode forward on voltage	V <sub>F</sub>	–	–	3.0	I <sub>F</sub> =200A, V <sub>GE</sub> =0V	V
Reverse recovery time	t <sub>rr</sub>	–	–	0.3	I <sub>F</sub> =200A	μs

#### ● Thermal resistance characteristics

Item	Symbol	Characteristics			Conditions	Unit
		Min.	Typ.	Max.		
Thermal resistance	R <sub>th(j-c)</sub>	–	–	0.16	IGBT	°C/W
	R <sub>th(j-c)</sub>	–	–	0.35	Diode	°C/W
	R <sub>th(c-f)*2</sub>	–	0.025	–	the base to cooling fin	°C/W

\*2 : This is the value which is defined mounting on the additional cooling fin with thermal compound

Characteristics (Representative)

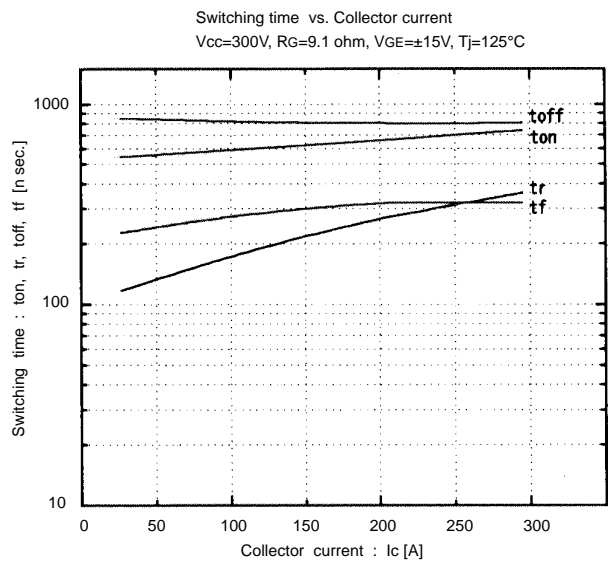
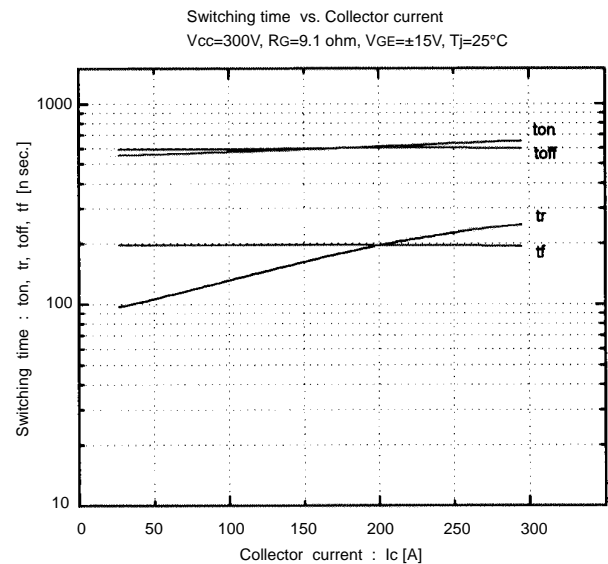
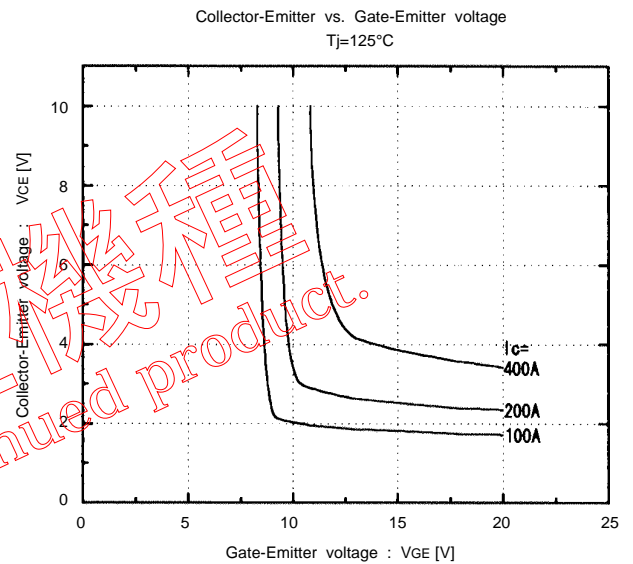
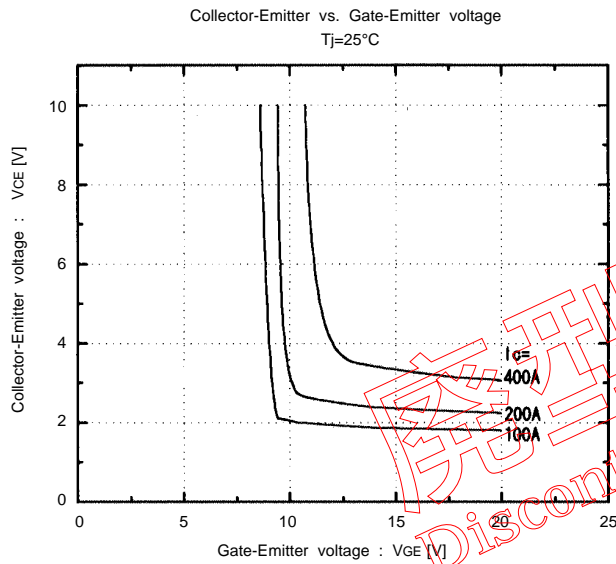
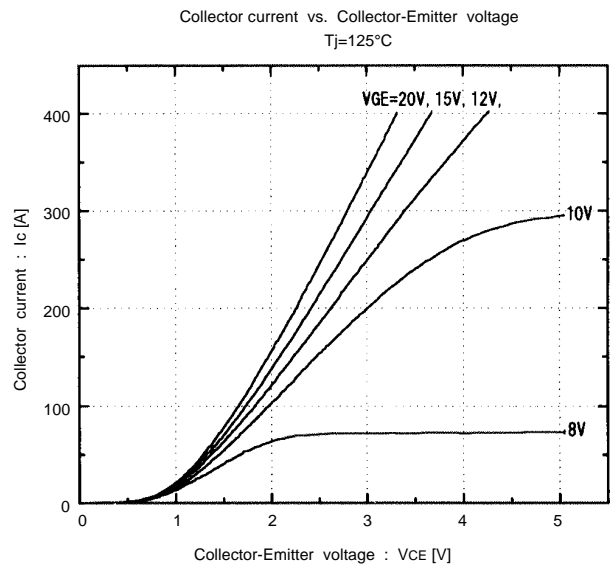
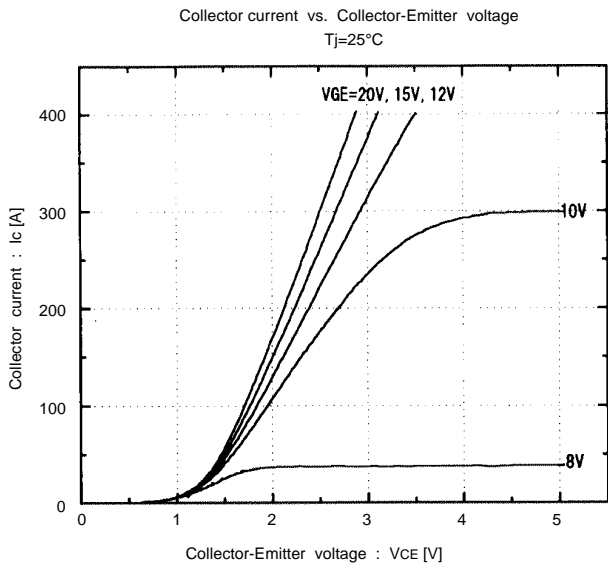

Switching time vs.  $R_G$   
 $V_{CC}=300V, I_c=200A, V_{GE}=\pm 15V, T_j=25^\circ C$

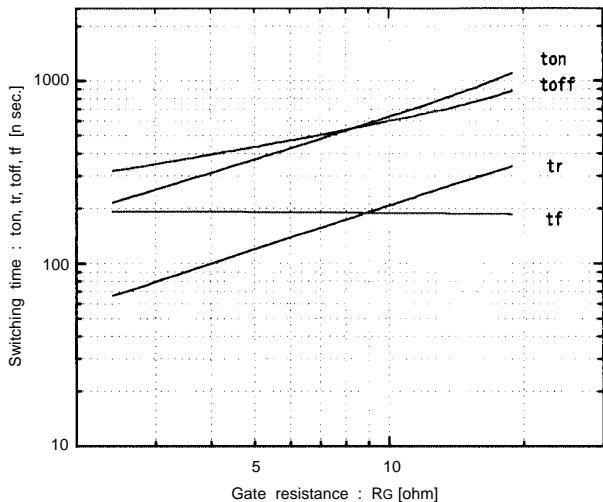

Dynamic input characteristics  
 $T_j=25^\circ C$

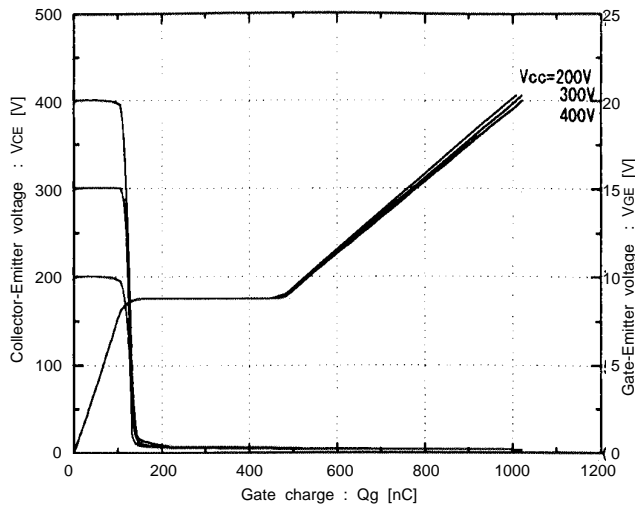

Forward current vs. Forward voltage  
 $V_{GE}=0V$

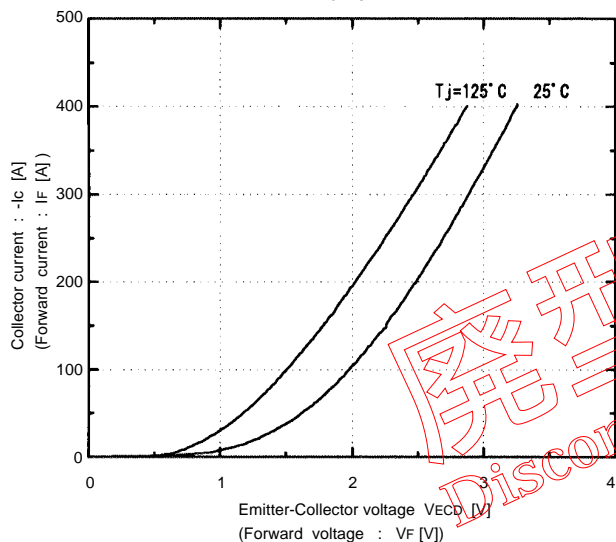

Reverse recovery characteristics  
 $t_{rr}, I_{rr}$ , vs.  $I_F$

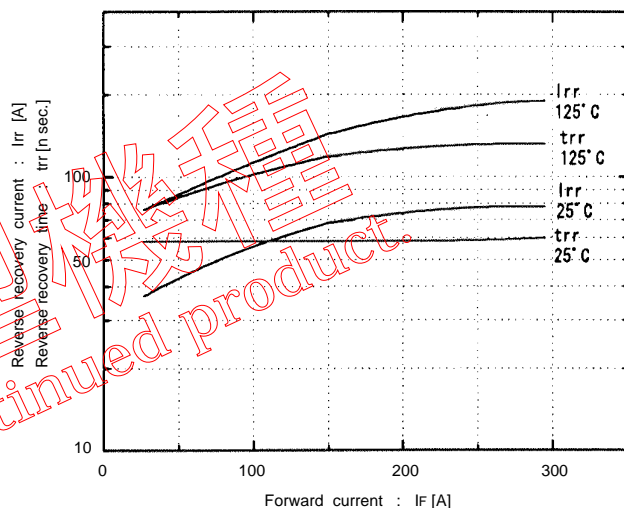

Switching loss vs. Collector current  
 $V_{CC}=300V, R_G=9.1\text{ ohm}, V_{GE}=\pm 15V$

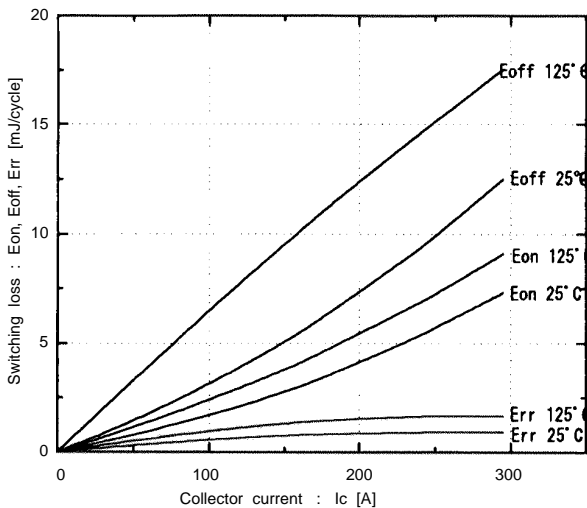

Reversed biased safe operating area  
 $+V_{GE}=15V, -V_{GE} \leq 15V, T_j \leq 125^\circ C, R_G \geq 9.1\text{ ohm}$

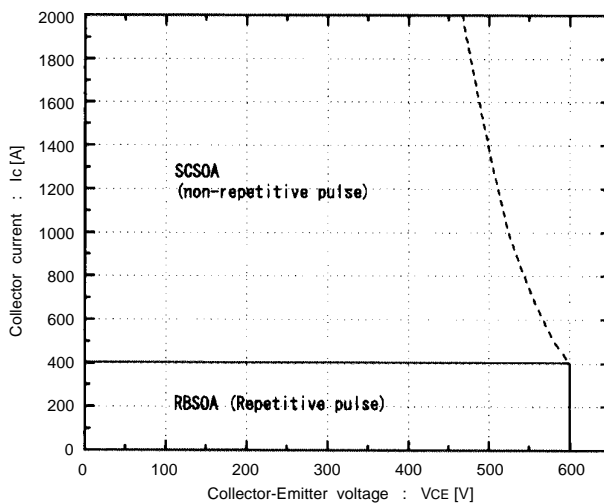

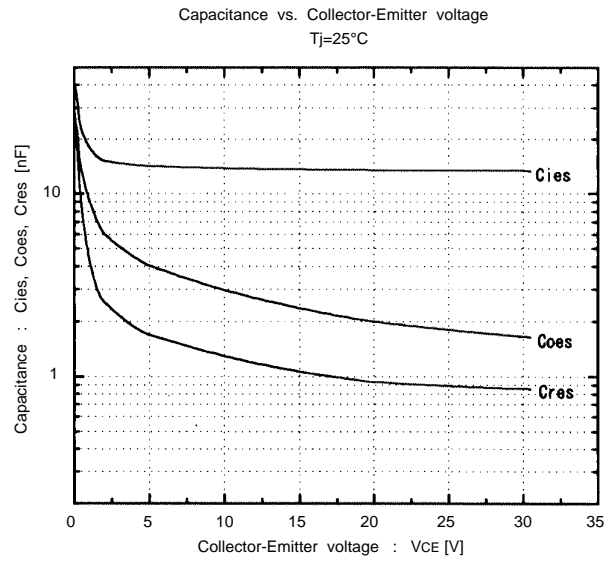
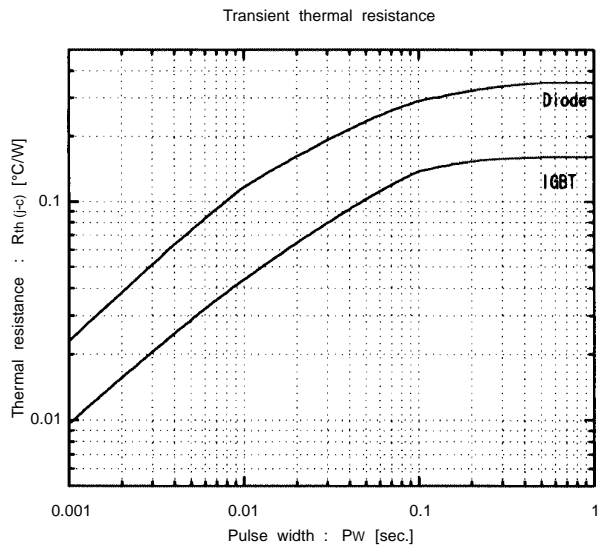

■ Outline Drawings, mm

