

SPECIFICATION

Device Name : IGBT module

Type Name : 2MBI200NT-120-02

Spec. No. : **MS5F3938**

This material and the information herein is the property of Fuji Electric Co., Ltd. They shall be neither reproduced, copied, lent, or disclosed in any way whatsoever for the use of any third party nor used for the manufacturing purposes without the express written consent of Fuji Electric Co., Ltd.

Fuji Electric Co., Ltd.
Matsumoto Factory

	DATE	NAME	APPROVED	Fuji Electric Co., Ltd.	
DRAWN	Feb. -21-'97	<i>Z. Kobayashi</i>	<i>S.K</i>	MS5F3938	1/7
CHECKED	Feb. -21-'97	<i>S. Hiyasaka</i>			a

Revised Records

Date	Classi- fication	Ind.	Content	Applied date	Drawn	Checked	Approved
Feb. 21. '47	enactment	—	—	Issued date	—	S. Koyama	S. K.
Apr. 18. '47	Revision	a	P5/T Revers gate bias voltage		J. Koyama	S. Koyama	S. K.

This material and the information herein is the property of Fuji Electric Co. Ltd. They shall be neither reproduced, copied, lent, or disclosed in any way whatsoever for the use of any third party nor used for the manufacturing purposes without the express written consent of Fuji Electric Co., Ltd.

2MBI200NT-120-02

1. Outline Drawing
Unit : mm

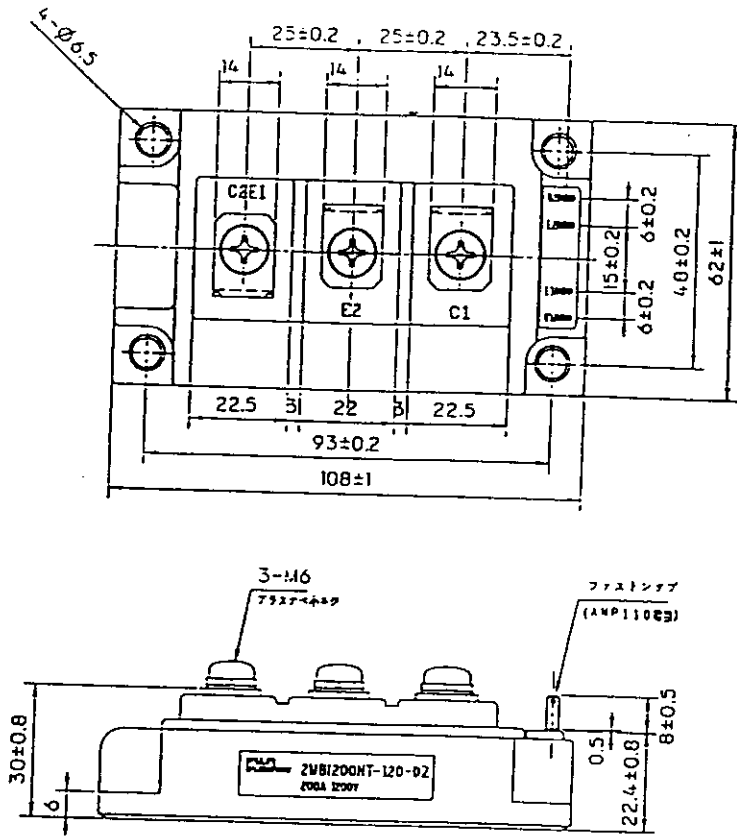

This material and the information herein is the property of Fuji Electric Co., Ltd. They shall be neither reproduced, copied, lent, or disclosed in any way whatsoever for the use of any third party nor used for the manufacturing purposes without the express written consent of Fuji Electric Co., Ltd.

2. Equivalent circuit

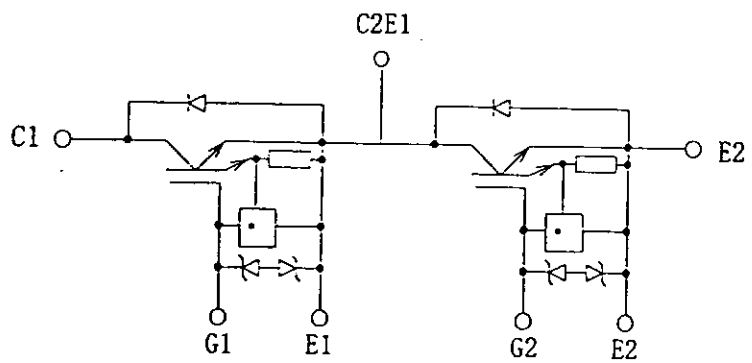

* NLU (Over Current Limiting Circuit)

Fuji Electric Co., Ltd.

DWG. NO.

MS5F3938

3/7

1	
2	
3	

H04-004-03

3. Absolute Maximum Ratings (at Tc=25°C unless otherwise specified)

Items		Symbols	Ratings	Units
Collector-Emitter voltage		V _{CEs}	1200	V
Gate-Emitter voltage		V _{GES}	±20	V
Collector current	Continuous	I _c	200	A
	1ms	I _c pulse	400	
		-I _c	200	
	1ms	-I _c pulse	400	
Max. power dissipation		PC	1650	W
Operating temperature		T _j	+150	°C
Storage temperature		T _{stg}	-40~+125	°C
Isolation voltage		V _{is}	AC 2500 (1min.)	V
Screw torque		Mounting *1	3.5	N·m
		Terminals *2	4.5	

Note : *1 Recommendable value : 2.5~3.5 N·m (M5) or (M6)

*2 Recommendable value : 3.5~4.5 N·m (M6)

4. Electrical characteristics (at T_j=25°C unless otherwise specified)

Items	Symbols	Characteristics			Conditions	Units
		min.	typ.	max.		
Zero gate voltage Collector current	I _{CEs}			2.0	V _{GE} =0V, V _{CE} =1200V	mA
Gate-Emitter leakage current	I _{GES}			30	V _{CE} =0V, V _{GE} =±20V	μA
Gate-Emitter threshold voltage	V _{GE(th)}	4.5		7.5	V _{CE} =20V, I _c =200mA	V
Collector-Emitter saturation voltage	V _{CE(sat)}			3.5	V _{GE} =15V, I _c =200A	V
Input capacitance	C _{ies}		32000		V _{GE} =0V	pF
Output capacitance	C _{oes}		15000		V _{CE} =10V	
Reverse transfer capacitance	C _{res}		12500		f=1MHz	
Turn-on time	t _{on}		0.65	1.2	V _{cc} =600V	μs
	t _r		0.25	0.6	I _c =200A	
Turn-off time	t _{off}		0.85	1.5	V _{GE} =±15V	μs
	t _f		0.35	0.5	R _G =4.7Ω	
Diode forward on voltage	V _F			3.4	I _F =200A, V _{GE} =0V	V
Reverse recovery time	t _{rr}			350	I _F =200A	ns
Short-circuit withstand capability	P _w	10			V _{cc} =800V, V _{GE} =-15V R _G =1.8Ω	μs

5. Thermal resistance characteristics

Items	Symbols	Characteristics			Conditions	Units
		min.	typ.	max.		
Thermal resistance	R _{th(j-c)}			0.077	IGBT	°C/W
	R _{th(j-c)}			0.20	Diode	
	※		0.025		the base to cooling	
	R _{th(c-f)}				fin	

※ This is the value which is defined mounting on the additional cooling fin with thermal compound.

Fuji Electric Co., Ltd.

DWG. NO.

MS5F3938

4/7

104-C04-03

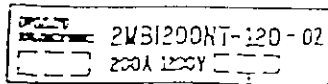

Lot No.

Place of manufacturing (code)

7. Applicable category (適用範囲)

This specification is applied to IGBT module named 2MBI200NT-120-02.
 本納入仕様書は、IGBTモジュール 2MBI200NT-120-02 に適用する。

8. Storage and transportation notes (保管、運搬上の注意事項)

- The IGBT module should be stored at a standard temperature of 5 to 35°C and humidity of 45 to 75%.
 常温保管が望ましい。(5~35°C、45~75%)
- Store modules in a place with few temperature changes in order to avoid condensation on the module surface.
 急激な温度変化の無きこと。(モジュール表面が結露しないこと)
- Avoid exposure to corrosive gases and dust.
 腐蝕性ガスの発生場所、塵埃の多い場所は避けること。
- Avoid excessive external force on the module.
 製品に荷重がかからないように十分注意すること。
- Store modules with unprocessed terminals.
 モジュールの端子は未加工の状態で保管すること。
- Do not drop or otherwise shock the modules when transporting.
 製品の運搬時に衝撃を与えたり、落下させたりしないこと。

9. Heat sink mounting notes (ヒートシンク取り付け上の注意事項)

- The mounting surface of the heat sink should be finished to a roughness of 10 μ m or less and a warp between screw holes of 100 μ m or less.
 本モジュールを取り付ける冷却体の取付面の仕上げは、粗さ10 μ m以下、取付ネジ間で平坦度100 μ m以下とする。
- Each mounting screw should be fastened using a specified torque after pre-fastening using a 1/3 specified torque.
 取付けネジは、規定の1/3のトルクで仮締を行った後、規定のトルクで本締を行って下さい。
- If the above notes are not met, it has a possibility to break the insulation between the IGBT module's chips and metal base.
 上記注意事項の範囲外で御適用した場合、IGBTモジュールのチップと金属ベース間の絶縁破壊を生ずる可能性があります。

⑩ Revers gate bias voltage (ゲート逆バイアス電圧)

- ① Recommendable value of the revers gate bias voltage : -7V(typ.), -5V(min.) $R_G=4.7\Omega$
 ゲート逆バイアス電圧の推奨値 : -7V(typ.), -5V(min.) $R_G=4.7\Omega$
- ② The revers gate bias voltage means the voltage between the gate terminal and the auxiliary emitter terminal of the modules.
 ゲート逆バイアス電圧は、モジュールのゲート端子と補助エミッタ端子間の電圧である。

Fuji Electric Co., Ltd

DWG. NO.

MS5F3938

5/7

a
1
1
1

This manual and the information herein is the property of Fuji Electric Co., Ltd. They shall be neither reproduced, copied, lent, or disclosed in any way whatsoever for the use of any third party or used for the manufacturing purposes without the express written consent of Fuji Electric Co., Ltd.

Collector current vs. Collector-Emitter voltage
Tj=25°C

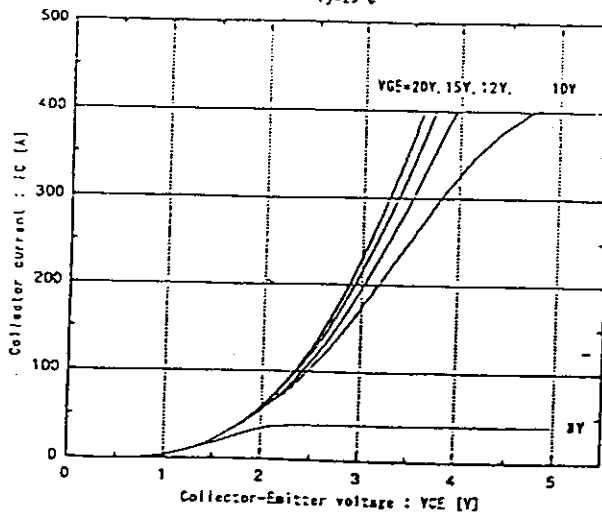

Collector current vs. Collector-Emitter voltage
Tj=135°C

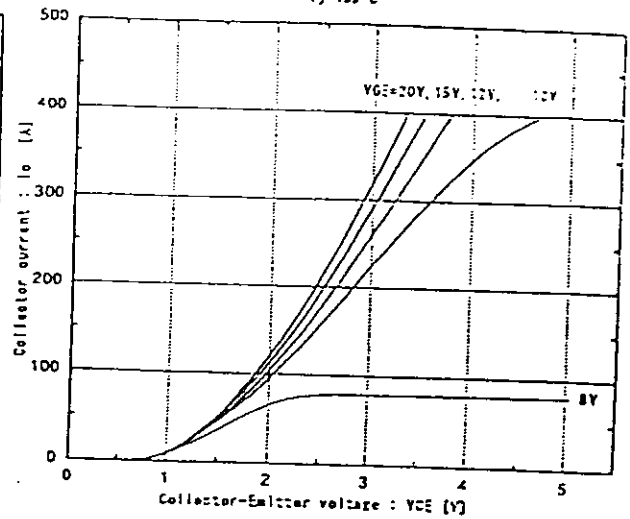

Switching time vs. Collector current
Vcc=700V, Rθ=1.8Ω, VGE=15V/-5V, Tj=25°C

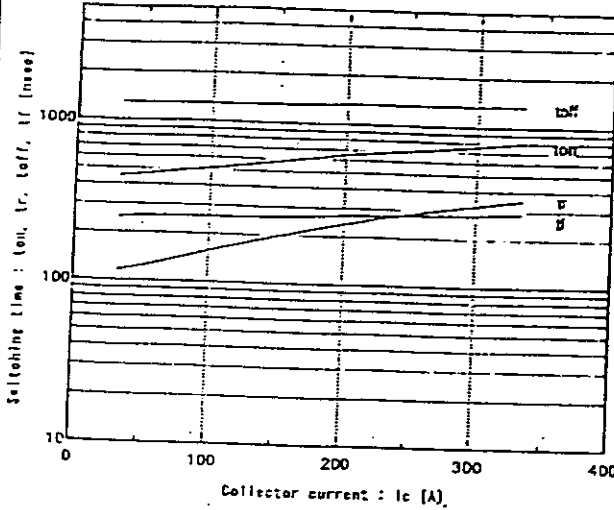

Switching time vs. Collector current
Vcc=700V, Rθ=1.8Ω, VGE=15V/-5V, Tj=135°C

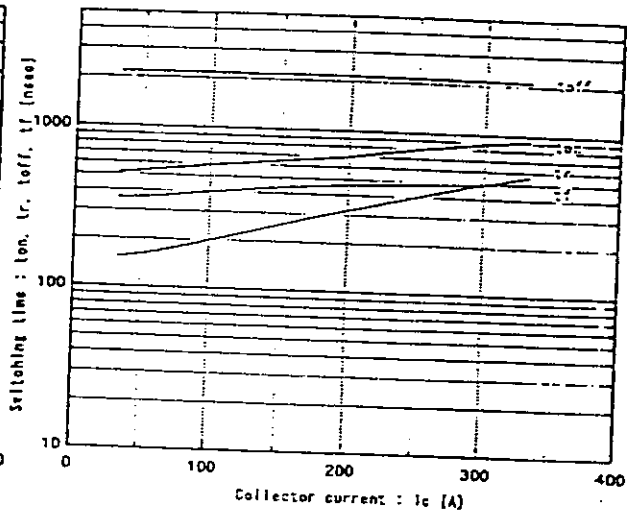

Switching loss vs. Collector current
Vcc=700V, Rθ=1.8Ω, VGE=15V/-5V

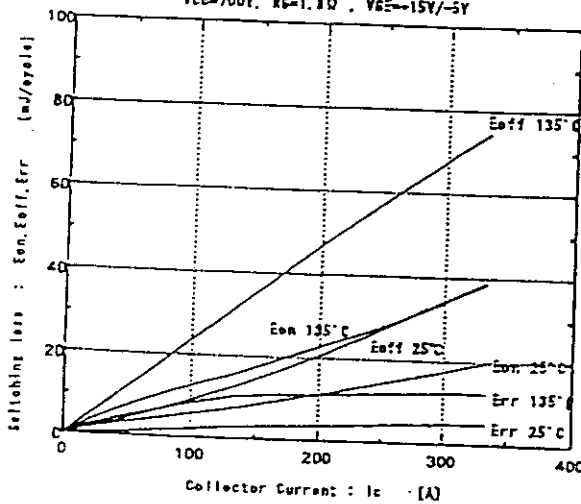

Capacitance vs. Collector-Emitter voltage
Tj=25°C

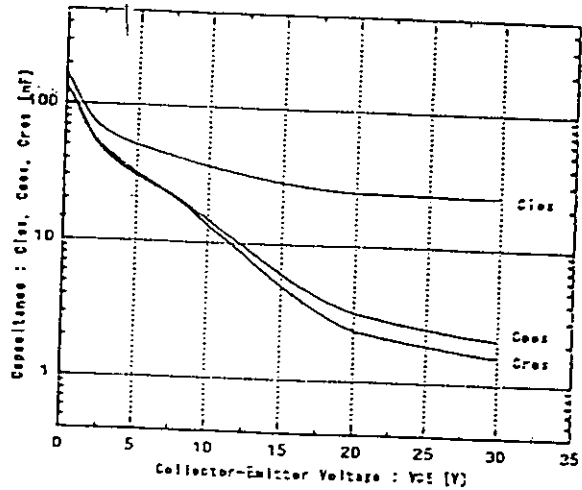

This material and the information herein is the property of Fuji Electric Co., Ltd. They shall be neither reproduced, copied, lent, or disclosed in any way whatsoever for the use of any third party nor used for the manufacturing purposes without the express written consent of Fuji Electric Co., Ltd.

Fuji Electric Co., Ltd.

DWG.NO.

MS5F3938

6/7

ai

This material and the information herein is the property of Fuji Electric Co., Ltd. They shall be neither reproduced, copied, lent, or disclosed in any way whatsoever for the use of any third party nor used for the manufacturing purposes without the express written consent of Fuji Electric Co., Ltd.

Switching time vs. R_G
 $V_{CC}=700V, I_c=200A, V_{GE}=-15V/-5V, T_j=25^\circ C$

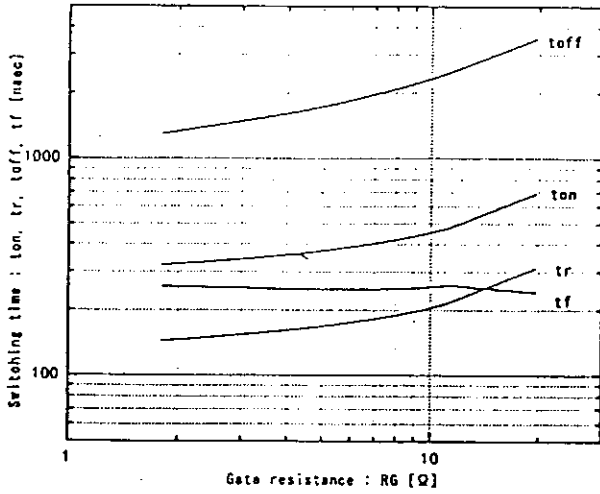

Dynamic input characteristics
 $T_j=25^\circ C$

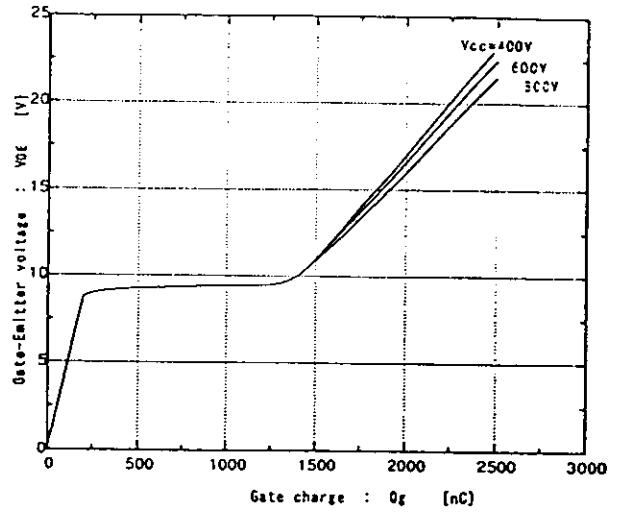

Forward current vs. Forward voltage
 $V_{GE}=0V$

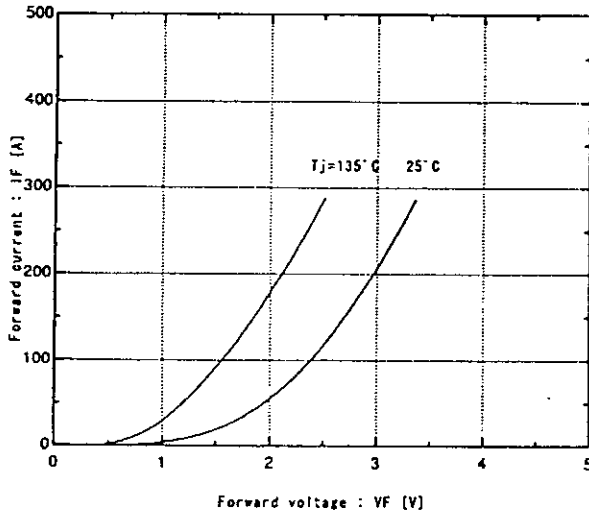

Reverse recovery characteristics
 t_{rr}, I_{rr} vs. I_F

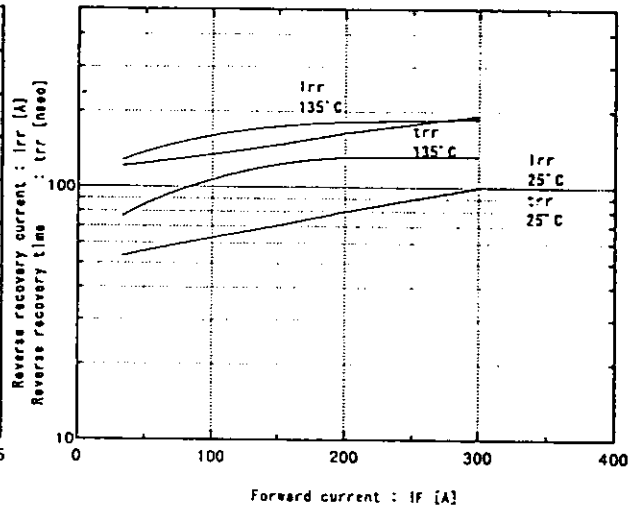

Transient thermal resistance

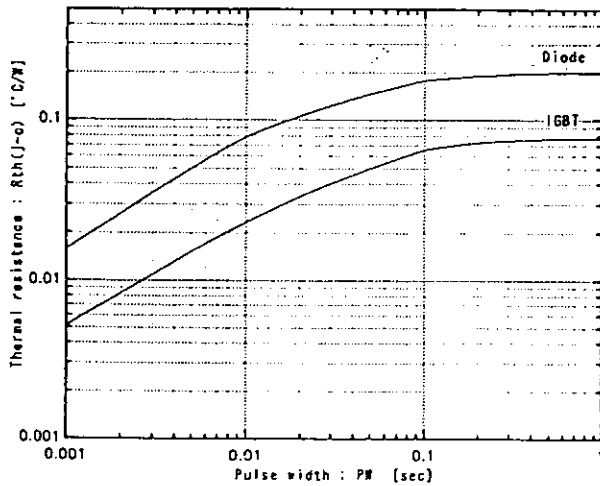

Reversed biased safe operating area
 $-V_{GE}=15V, -V_{GE} \leq 15V, T_j \leq 135^\circ C, R_G \geq 1.8\Omega$

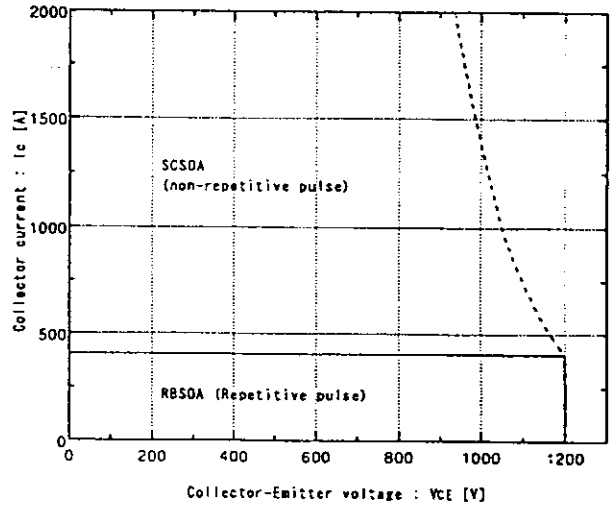

Fuji Electric Co., Ltd.

DWG/NO

MS5F3938

7/7