

2MBI300N-060-04

IGBT Module

600V / 300A 2 in one-package

■ Features

- VCE(sat) classified for easy parallel connection
- High speed switching
- Voltage drive
- Low inductance module structure

■ Applications

- Inverter for Motor drive
- AC and DC Servo drive amplifier
- Uninterruptible power supply
- Industrial machines, such as Welding machines

■ Maximum ratings and characteristics

● Absolute maximum ratings (at Tc=25°C unless otherwise specified)

Item	Symbol	Rating	Unit
Collector-Emitter voltage	V _{CEs}	600	V
Gate-Emitter voltage	V _{GEs}	±20	V
Collector current	Continuous	I _c	300
	1ms	I _c pulse	600
		-I _c	300
	1ms	-I _c pulse	600
Max. power dissipation	P _c	1100	W
Operating temperature	T _j	+150	°C
Storage temperature	T _{stg}	-40 to +125	°C
Isolation voltage	V _{is}	AC 2500 (1min.)	V
Screw torque	Mounting *1	3.5	N·m
	Terminals *1	3.5	N·m

*1 : Recommendable value : 2.5 to 3.5 N·m(M5)

● Electrical characteristics (at T_j=25°C unless otherwise specified)

Item	Symbol	Characteristics			Conditions	Unit
		Min.	Typ.	Max.		
Zero gate voltage collector current	I _{CEs}	–	–	2.0	V _{GE} =0V, V _{CE} =600V	mA
Gate-Emitter leakage current	I _{GEs}	–	–	30	V _{CE} =0V, V _{GE} =±20V	μA
Gate-Emitter threshold voltage	V _{GE(th)}	4.5	–	7.5	V _{CE} =20V, I _c =300mA	V
Collector-Emitter saturation voltage	V _{CE(sat)}	–	–	2.8	V _{GE} =15V, I _c =300A	V
Input capacitance	C _{ies}	–	19800	–	V _{GE} =0V	pF
Output capacitance	C _{oes}	–	4400	–	V _{CE} =10V	
Reverse transfer capacitance	C _{res}	–	2000	–	f=1MHz	
Turn-on time	t _{on}	–	0.6	1.2	V _{CC} =300V	μs
	t _r	–	0.2	0.6	I _c =300A	
Turn-off time	t _{off}	–	0.6	1.0	V _{GE} =±15V	μs
	t _f	–	0.2	0.35	R _G =6.8ohm	
Diode forward on voltage	V _F	–	–	3.0	I _F =300A, V _{GE} =0V	V
Reverse recovery time	t _{rr}	–	–	0.3	I _F =300A	μs

● Thermal resistance characteristics

Item	Symbol	Characteristics			Conditions	Unit
		Min.	Typ.	Max.		
Thermal resistance	R _{th(j-c)}	–	–	0.11	IGBT	°C/W
	R _{th(j-c)}	–	–	0.24	Diode	°C/W
	R _{th(c-f)*2}	–	0.025	–	the base to cooling fin	°C/W

*2 : This is the value which is defined mounting on the additional cooling fin with thermal compound



■ Equivalent Circuit Schematic

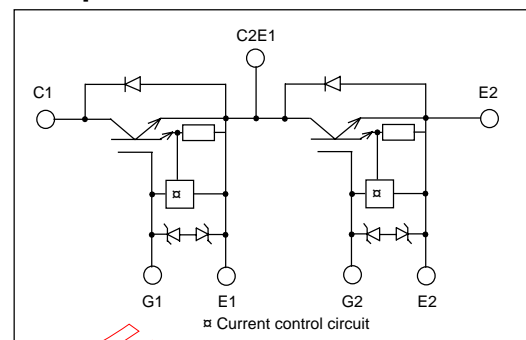

● V_{CE(sat)} classification

Rank	Length	Conditions
F	1.85 to 2.10V	I _c = 300A V _{GE} = 15V T _j = 25°C
A	2.00 to 2.25V	
B	2.15 to 2.40V	
C	2.30 to 2.60V	
D	2.50 to 2.80V	

■ Characteristics (Representative)

Collector current vs. Collector-Emitter voltage
T_j=25°C

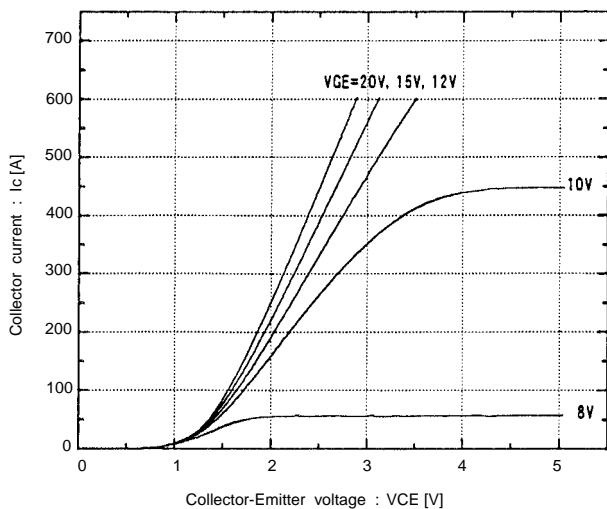

Collector current vs. Collector-Emitter voltage
T_j=125°C

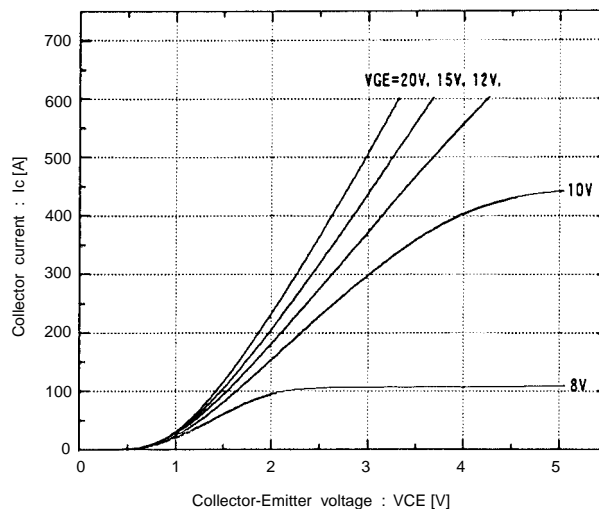

Collector-Emitter vs. Gate-Emitter voltage
T_j=25°C

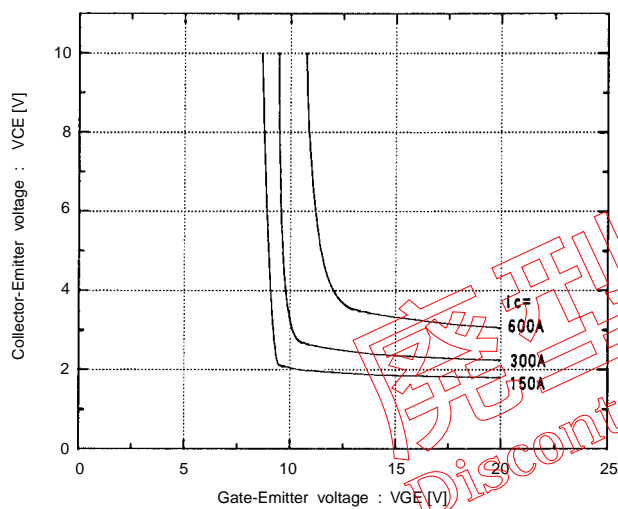

Collector-Emitter vs. Gate-Emitter voltage
T_j=125°C

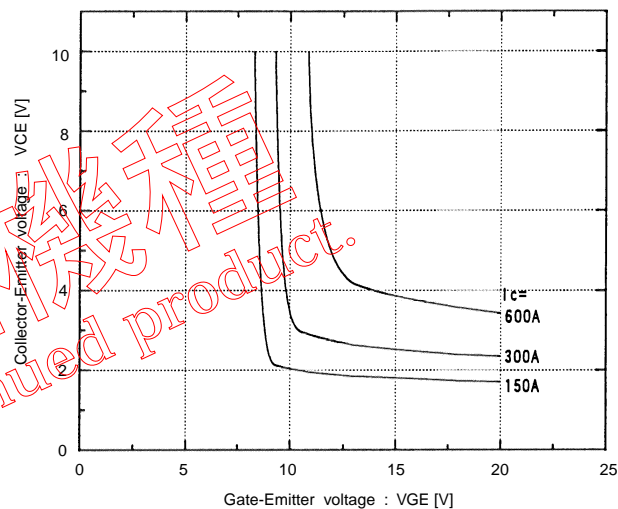

Switching time vs. Collector current
V_{cc}=300V, R_G=6.8 ohm, V_{GE}=±15V, T_j=25°C

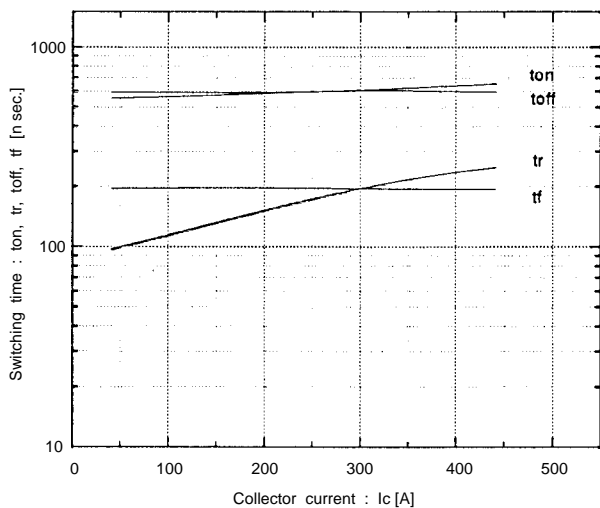

Switching time vs. Collector current
V_{cc}=300V, R_G=6.8 ohm, V_{GE}=±15V, T_j=125°C

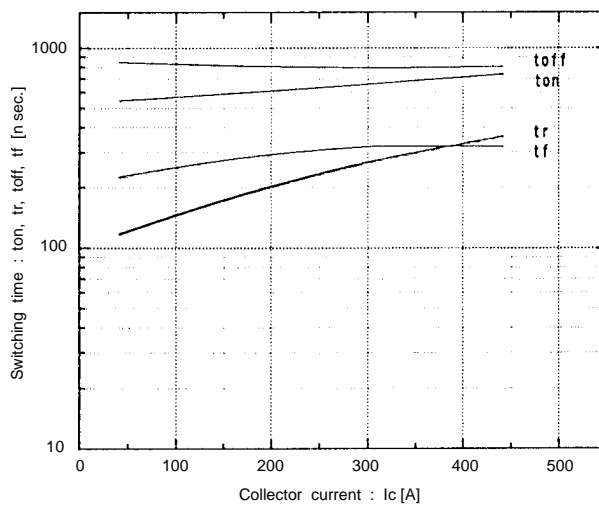

廢型機種
 Discontinued product

Switching time vs. RG
Vcc=300V, Ic=300A, VGE=±15V, Tj=25°C

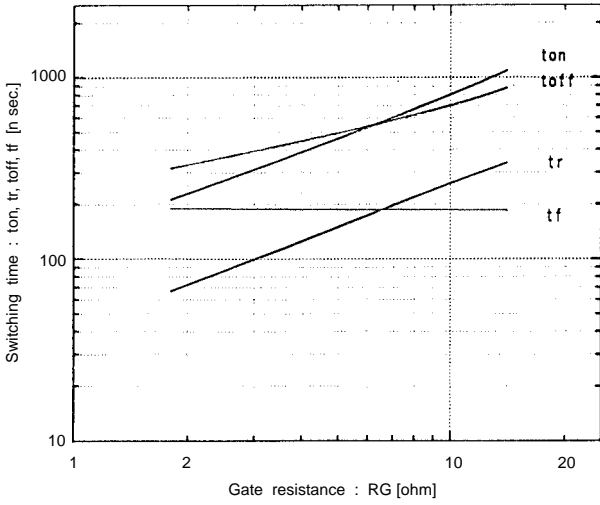

Dynamic input characteristics
Tj=25°C

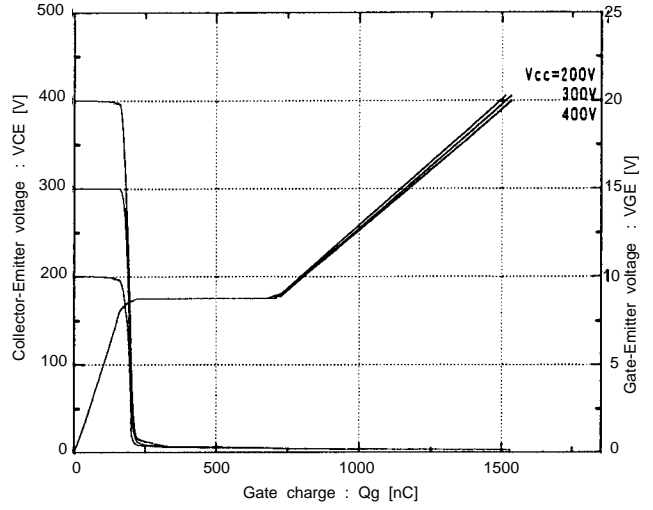

Forward current vs. Forward voltage
VGE=0V

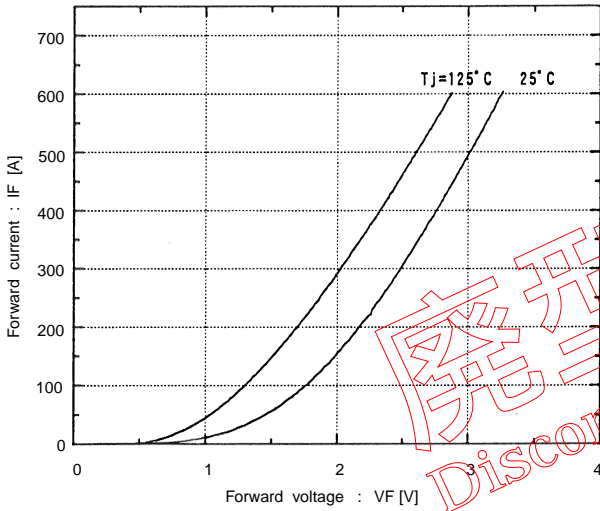

Reverse recovery characteristics
trr, Irr, vs. IF

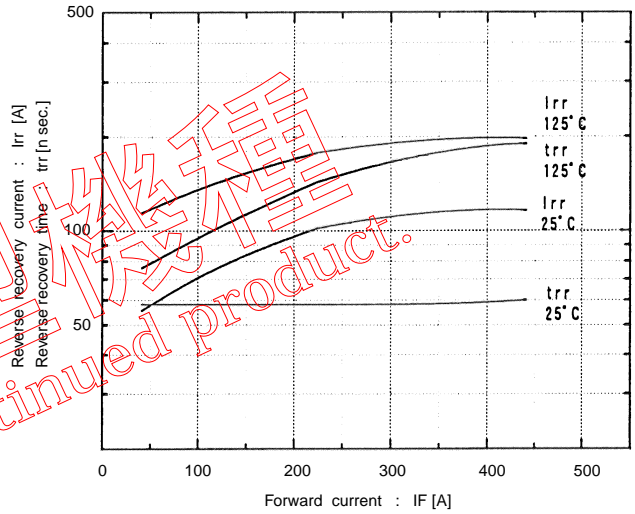

Transient thermal resistance

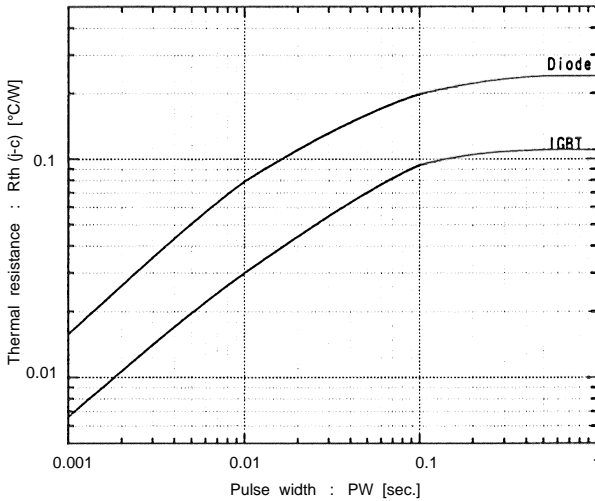

Reversed biased safe operating area
+VGE=15V, -VGE ≤ 15V, Tj ≤ 125°C, RG ≥ 6.8 ohm

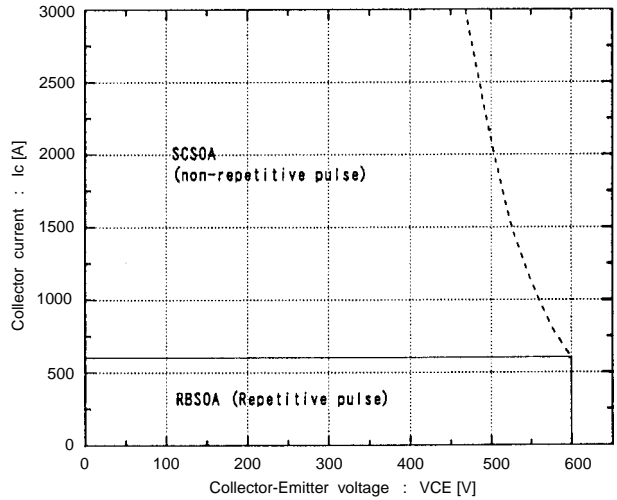

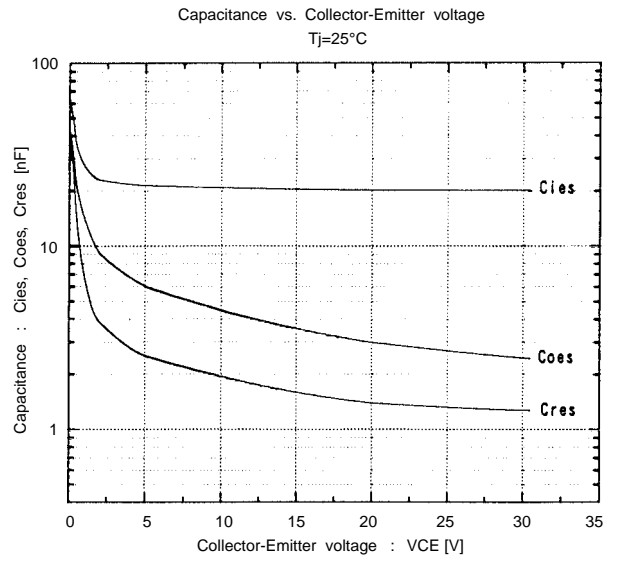
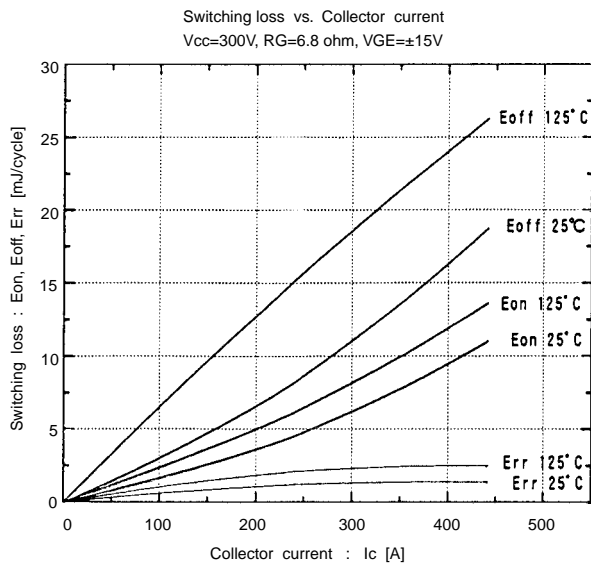

■ Outline Drawings, mm

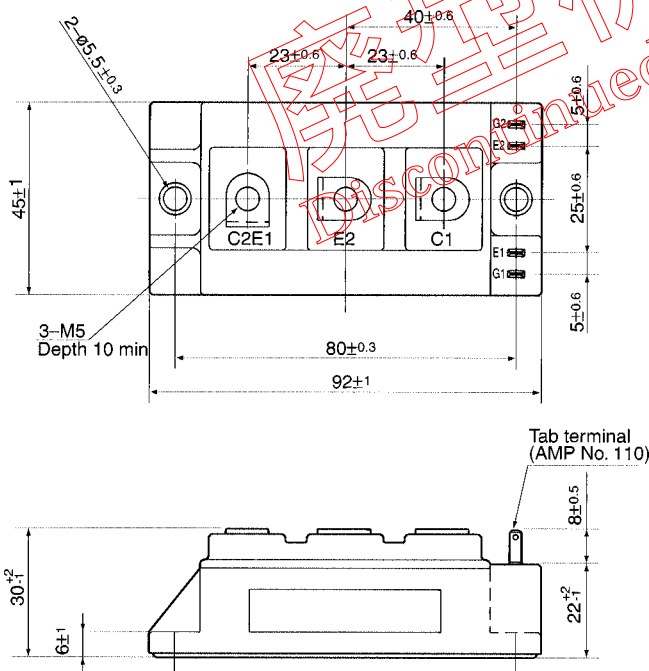

Mass : 240g