

## IGBT MODULE ( F series)

### ■ Features

- Low Saturation Voltage
- Voltage Drive
- Variety of Power Capacity Series

### ■ Applications

- Inverter for Motor Drive
- AC and DC Servo Drive Amplifier
- Uninterruptible Power Supply
- Industrial Machines, such as Welding Machines

### ■ Maximum Ratings and Characteristics

#### ● Absolute Maximum Ratings

Items	Symbols	Ratings	Units
Collector-Emitter Voltage	V <sub>CEs</sub>	600	V
Gate-Emitter Voltage	V <sub>GES</sub>	±20	V
Collector Current	Continuous	I <sub>c</sub>	50
	1ms	I <sub>c pulse</sub>	100
	Continuous	-I <sub>c</sub>	50
	1ms	-I <sub>c pulse</sub>	100
Max. Power Dissipation	P <sub>c</sub>	220	W
Operating Temperature	T <sub>j</sub>	+150	°C
Storage Temperature	T <sub>stg</sub>	-40 to +125	°C
Net. Weight		185	g
Isolation Voltage	AC. 1min.	V <sub>isol</sub>	2500
Screw Torque	Mounting *1	3.5 [35]	N · m
	Terminals *1	3.5 [35]	{kg · cm}

\*1 Recommendable Value 2.5 to 3.5 N·m {25 to 35 kg·cm} (M5)

#### ● Electrical Characteristics (T<sub>c</sub>=25°C)

Items	Symbols	Test Conditions	Min.	Typ.	Max.	Units
Zero Gate Voltage Collector Current	I <sub>CEs</sub>	V <sub>GE</sub> =0V V <sub>CE</sub> =600V T <sub>j</sub> =25°C			1.0	mA
		V <sub>GE</sub> =0V V <sub>CE</sub> =600V T <sub>j</sub> =125°C			—	mA
Gate-Emitter Leakage Current	I <sub>GES</sub>	V <sub>CE</sub> =0V V <sub>GE</sub> =±20V			100	nA
Gate-Emitter Threshold Voltage	V <sub>GE(th)</sub>	V <sub>CE</sub> =20V I <sub>c</sub> =50mA	3.0		6.0	V
Collector-Emitter Saturation Voltage	V <sub>CE(sat)</sub>	V <sub>GE</sub> =15V I <sub>c</sub> =50A			2.5	V
Input Capacitance	C <sub>ies</sub>	V <sub>GE</sub> =0V		4750		pF
Output Capacitance	C <sub>oes</sub>	V <sub>CE</sub> =10V		—		
Reverse Transfer Capacitance	C <sub>res</sub>	f=1MHz		—		
Turn-on Time	t <sub>on</sub>	V <sub>CC</sub> =300V			0.8	μs
	t <sub>r</sub>	I <sub>c</sub> =50A			0.6	
Turn-off Time	t <sub>off</sub>	V <sub>GE</sub> =±15V			1.5	
	t <sub>f</sub>	R <sub>G</sub> =51Ω			1.0	
Diode Forward On-Voltage	V <sub>F</sub>	I <sub>F</sub> =50A, V <sub>GE</sub> =0V			2.5	V
Reverse Recovery Time	t <sub>rr</sub>	I <sub>F</sub> =50A, -di/dt=150A/μs V <sub>GE</sub> =-10V			300	ns

#### ● Thermal Characteristics

Items	Symbols	Test Conditions	Min.	Typ.	Max.	Units
Thermal Resistance	R <sub>th(j-c)</sub>	IGBT			4.31	°C/W
	R <sub>th(j-e)</sub>	Diode			0.888	
	R <sub>th(c-f)</sub>	With Thermal compound		0.05		

### ■ Outline Drawings

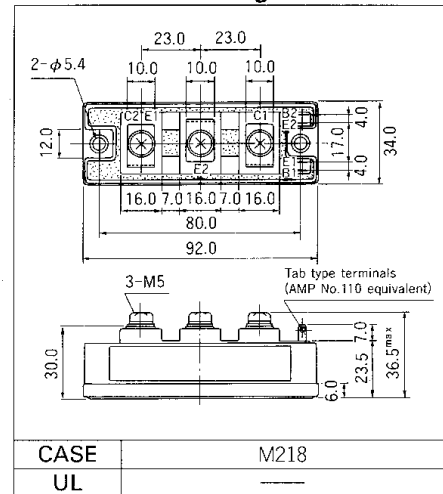

### ■ Equivalent Circuit Schematic

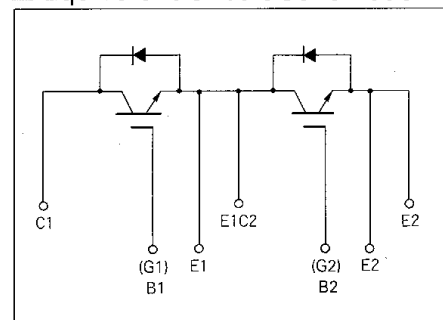

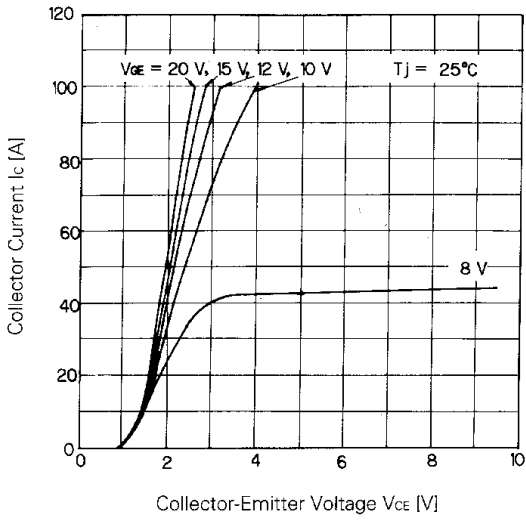

Collector Current vs. Collector-Emitter Voltage

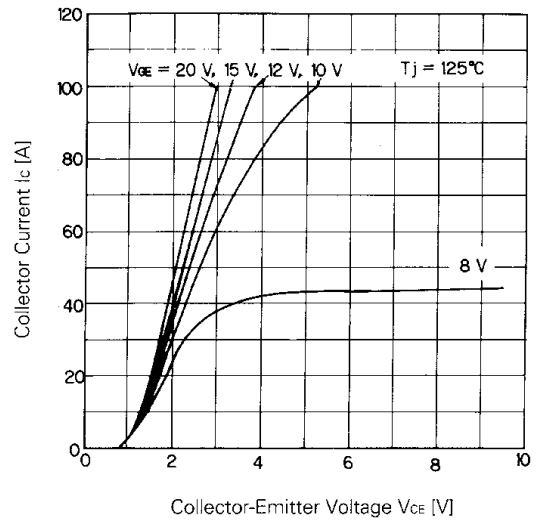

Collector Current vs. Collector-Emitter Voltage

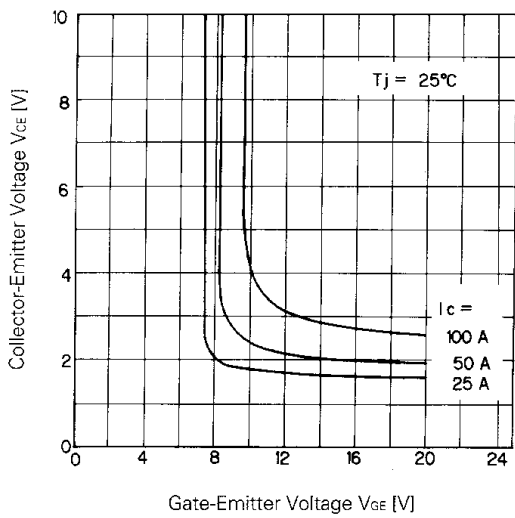

Collector-Emitter Voltage vs. Gate-Emitter Voltage

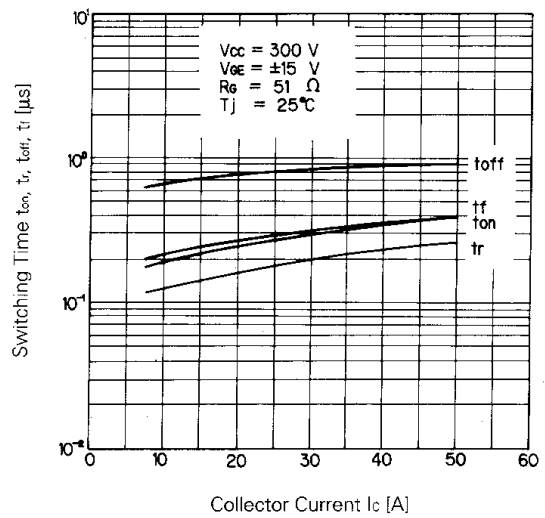

Switching Time

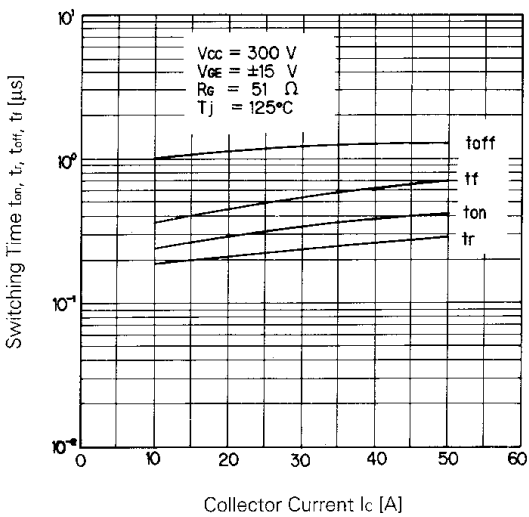

Switching Time

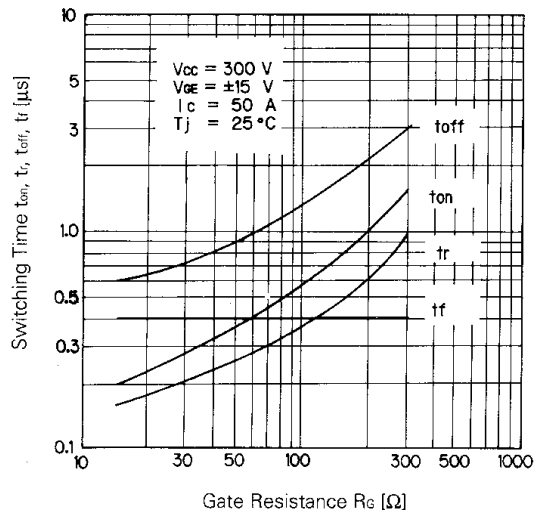

Switching Time-Gate Resistance

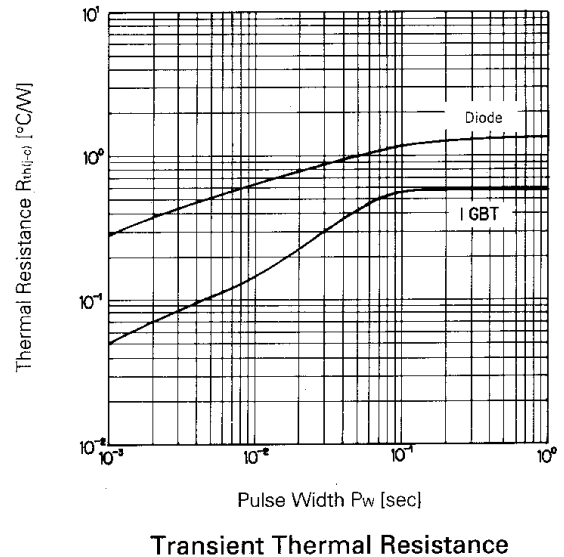
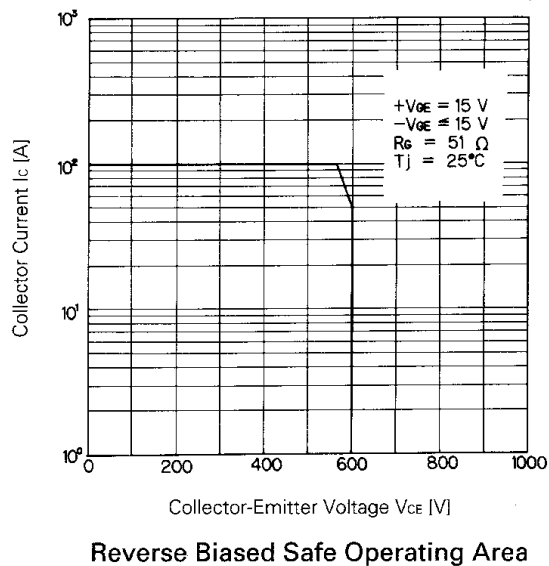
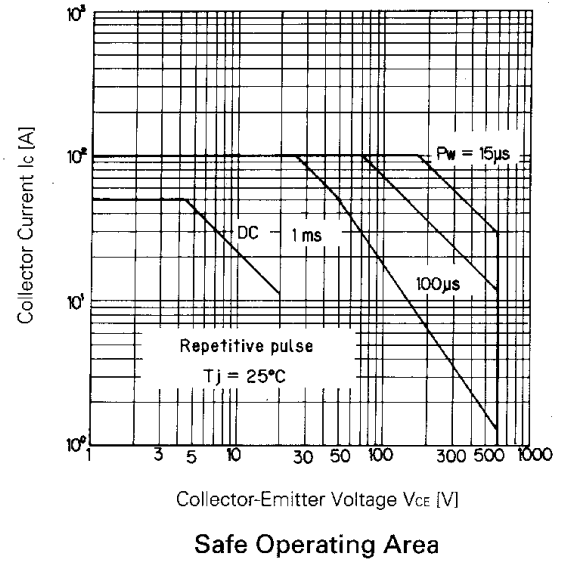
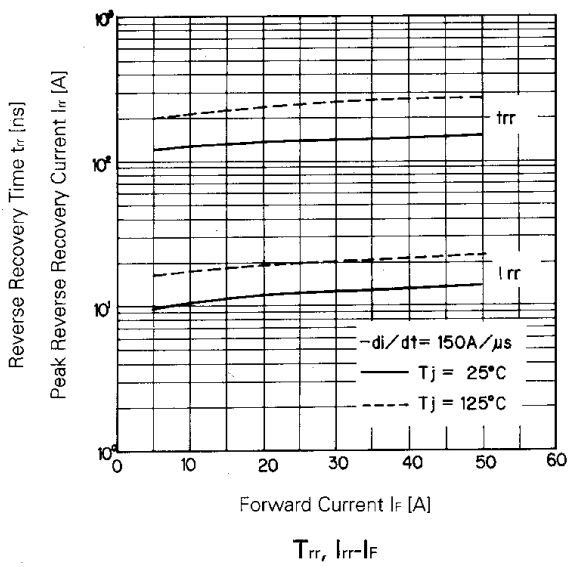
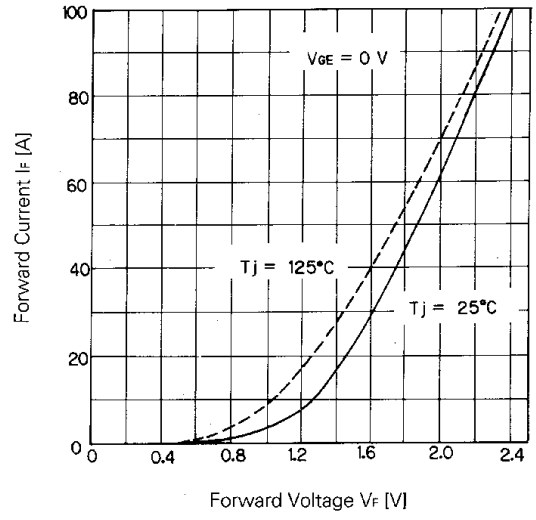
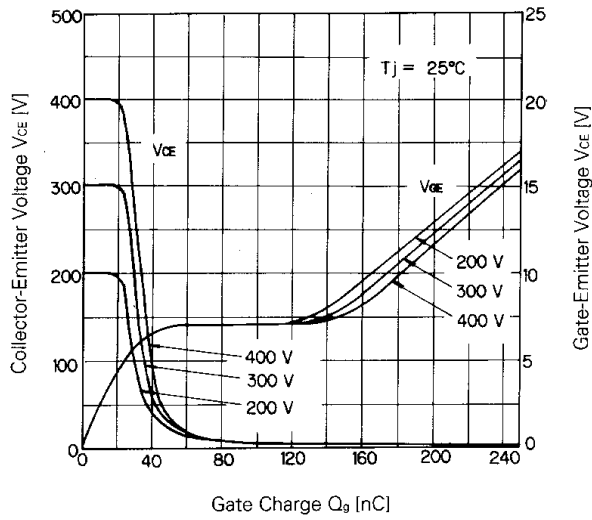

For more information, contact:

**Collmer Semiconductor, Inc.**

P.O. Box 702708

Dallas, TX 75370

972-733-1700

972-381-9991 Fax

<http://www.collmer.com>