

P-CHANNEL SILICON POWER MOSFET

FAP-III SERIES

Features

- High speed switching
- Low on-resistance
- No secondary breakdown
- Low driving power
- High forward Transconductance
- Avalanche-proof

Applications

- Switching regulators
- DC-DC converters
- General purpose power amplifier

Outline Drawings

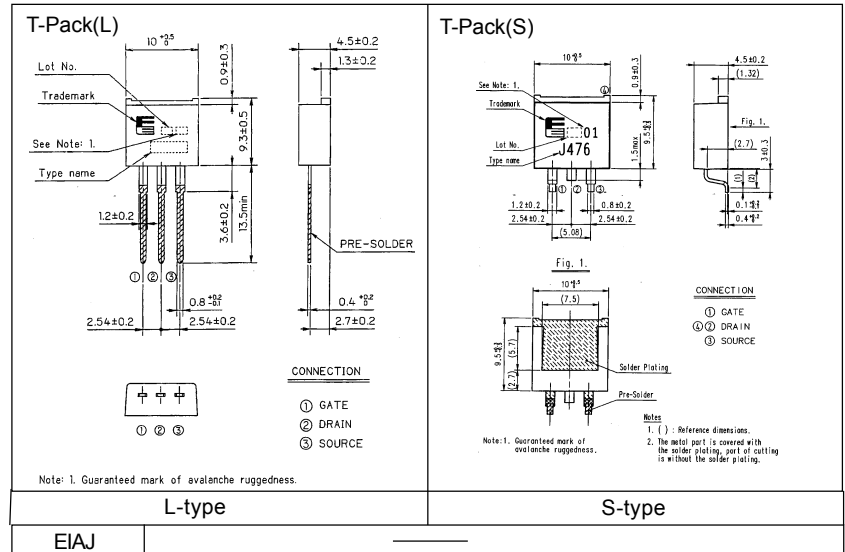

Maximum ratings and characteristics

Absolute maximum ratings (Tc=25°C unless otherwise specified)

Item	Symbol	Rating	Unit
Drain-source voltage	V _{DS}	-60	V
Continuous drain current	I _D	±25	A
Pulsed drain current	I _{D(puls)}	±100	A
Gate-source voltage	V _{GS}	±20	V
Maximum avalanche energy *1	E _{AV}	325.9	mJ
Maximum power dissipation(Tc=25°C)	P _D	50	W
Operating and storage temperature range	T _{ch} T _{stg}	+150 -55 to +150	°C

*1 L=0.695mH, V_{CC}= -24V

Equivalent circuit schematic

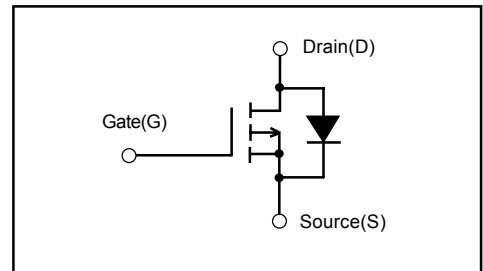

Electrical characteristics (Tc =25°C unless otherwise specified)

Item	Symbol	Test Conditions	Min.	Typ.	Max.	Units
Drain-source breakdown voltage	BV _{DSS}	I _D =1mA V _{GS} =0V	-60			V
Gate threshold voltage	V _{GS(th)}	I _D =1mA V _{DS} =V _{GS}	-1.0	-1.5	-2.5	V
Zero gate voltage drain current	I _{DSS}	V _{DS} = -60V V _{GS} =0V	T _{ch} =25°C	-10	-500	μA
			T _{ch} =125°C	-0.2	-1.0	mA
Gate-source leakage current	I _{GSS}	V _{GS} =±20V V _{DS} =0V		10	100	nA
Drain-source on-state resistance	R _{DSON}	I _D = -12.5A	V _{GS} = -4V	80	110	mΩ
			V _{GS} = -10V	45	60	mΩ
Forward transconductance	g _{fs}	I _D =12.5A V _{DS} = -25V	7.5	15.0		S
Input capacitance	C _{iss}	V _{DS} = -25V		2000	3000	pF
Output capacitance	C _{oss}	V _{GS} =0V		700	1050	
Reverse transfer capacitance	C _{rss}	f=1MHz		450	680	ns
Turn-on time	t _{d(on)}	V _{CC} = -30V R _G =10 Ω		15	25	
	t _r	I _D = -25A		80	120	
Turn-off time	t _{d(off)}	V _{GS} = -10V		190	290	
	t _f			90	140	
Avalanche capability	I _{AV}	L=100μH T _{ch} =25°C	-25			A
Diode forward on-voltage	V _{SD}	I _F =2I _{IDR} V _{GS} =0V T _{ch} =25°C		-2	-3	V
Reverse recovery time	t _{rr}	I _F =I _{IDR} V _{GS} =0V		160		ns
Reverse recovery charge	Q _{rr}	-di/dt=100A/μs T _{ch} =25°C		0.9		μC

Thermal characteristics

Item	Symbol	Min.	Typ.	Max.	Units
Thermal resistance	R _{th(ch-c)}			2.50	°C/W
	R _{th(ch-a)}			75	°C/W

Characteristics

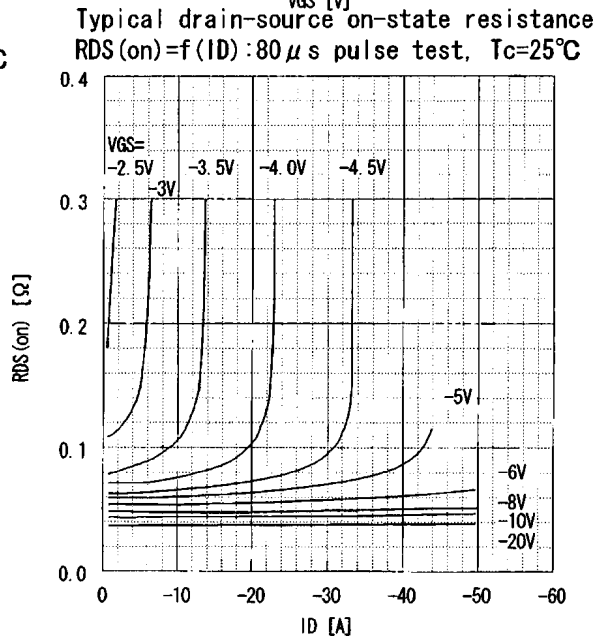
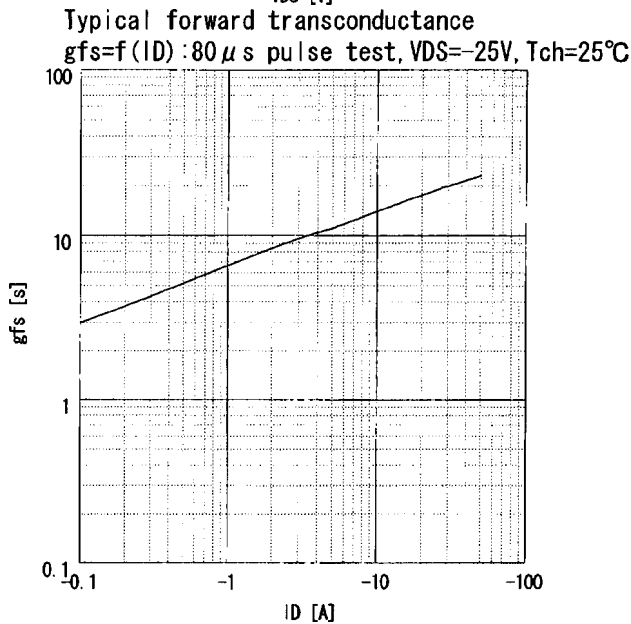
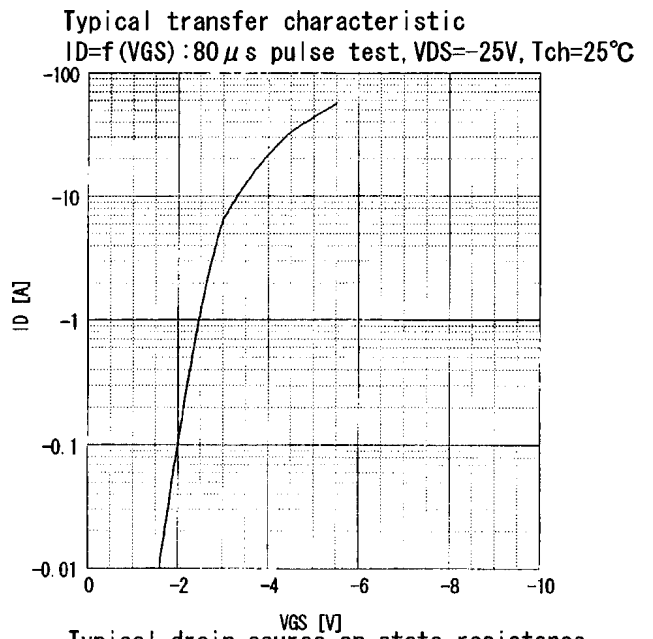
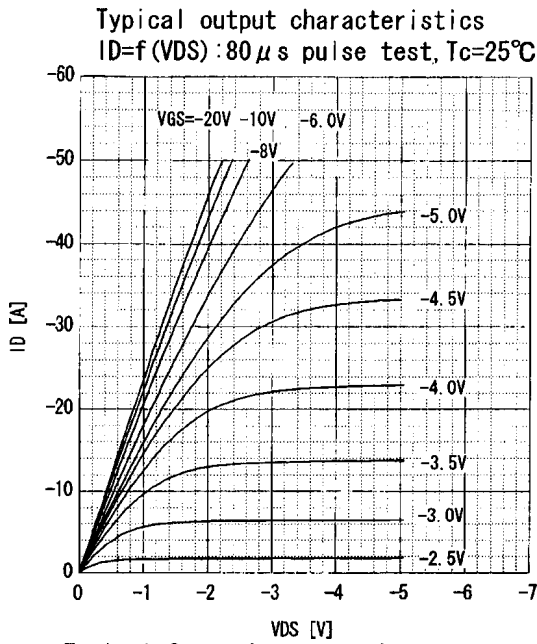
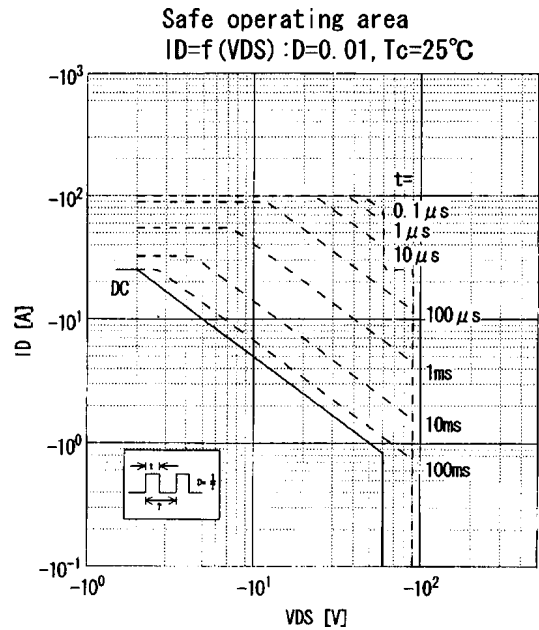
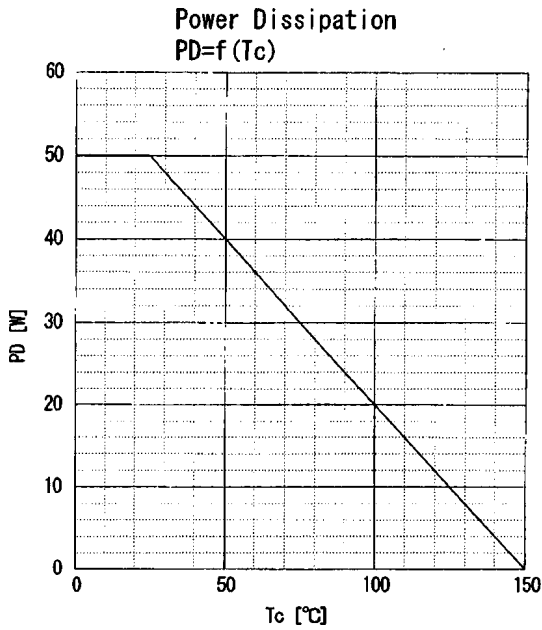

Drain-source on-state resistance
 $R_{DS(on)} = f(T_{ch}) : I_D = -12.5A, V_{GS} = 10V$

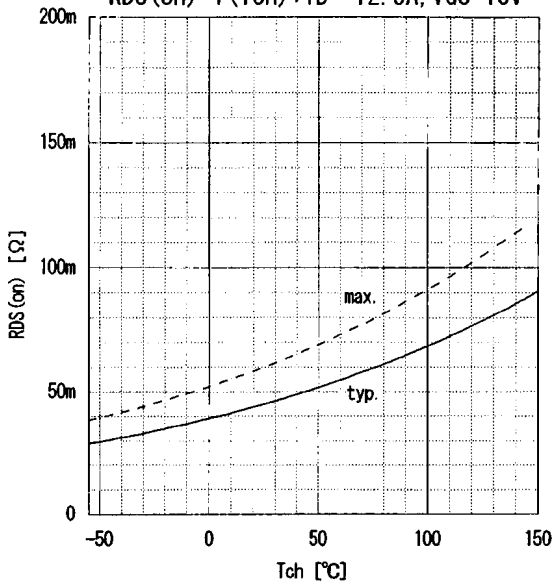

Gate threshold voltage
 $V_{GS(th)} = f(T_{ch}) : I_D = -1mA, V_{DS} = V_{GS}$

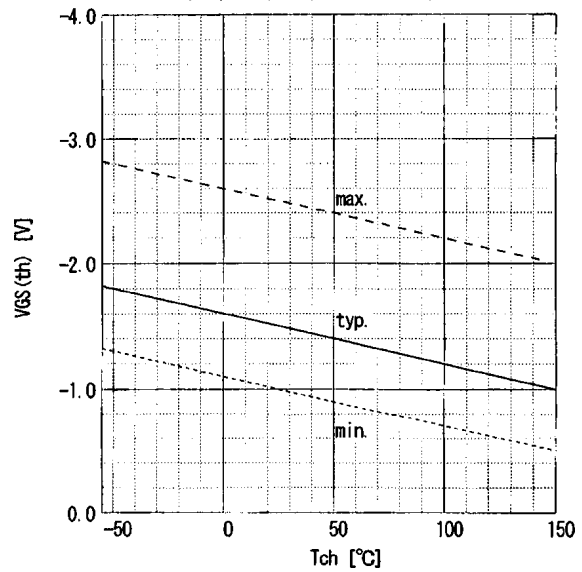

Typical gate charge characteristic
 $V_{GS} = f(Q_g) : I_D = -25A, T_c = 25°C$

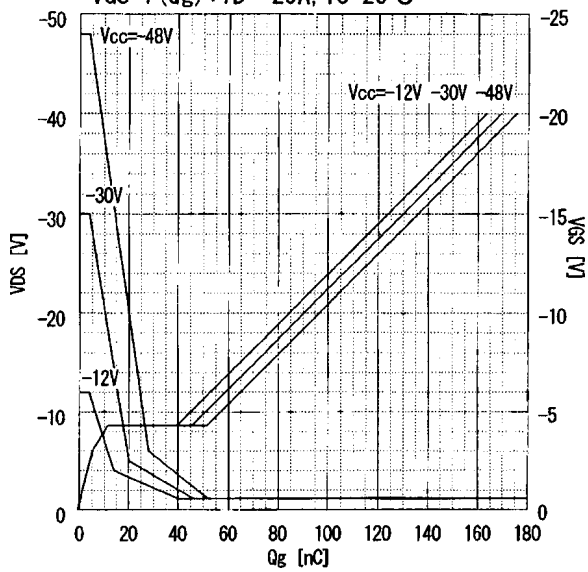

Typical capacitances
 $C = f(V_{DS}) : V_{GS} = 0V, f = 1MHz$

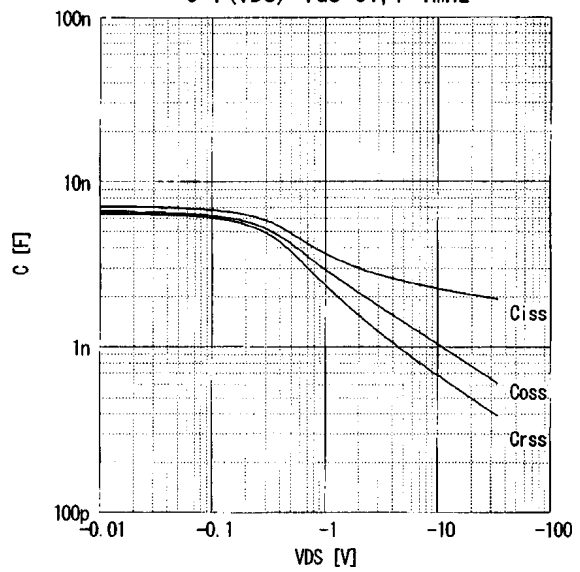

Maximum Avalanche Current vs. starting T_{ch}
 $I_{(AV)} = f(\text{starting } T_{ch})$

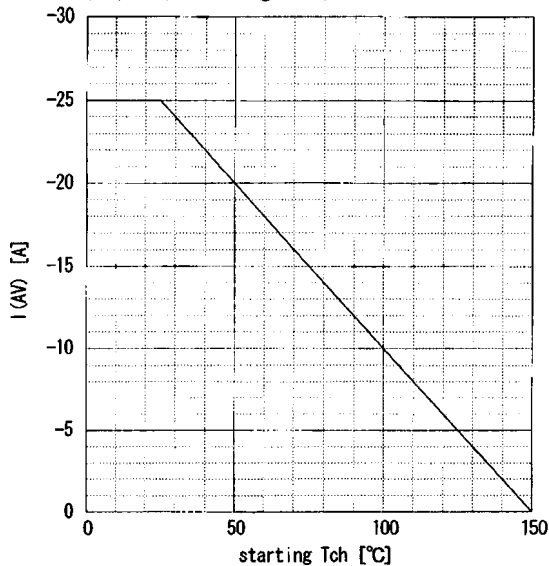

Maximum Avalanche Energy vs. starting T_{ch}
 $E_{(AV)} = f(\text{starting } T_{ch}) : V_{CC} = -24V, I_{(AV)} \geq -25A$

