

### P-CHANNEL SILICON POWER MOSFET

### FAP-III SERIES

#### Features

- High speed switching
- Low on-resistance
- No secondary breakdown
- Low driving power
- High forward Transconductance
- Avalanche-proof

#### Applications

- Switching regulators
- DC-DC converters
- General purpose power amplifier

#### Maximum ratings and characteristics

##### Absolute maximum ratings (Tc=25°C unless otherwise specified)

Item	Symbol	Rating	Unit
Drain-source voltage	V <sub>DS</sub>	-60	V
Continuous drain current	I <sub>D</sub>	±25	A
Pulsed drain current	I <sub>D(puls)</sub>	±100	A
Gate-source voltage	V <sub>GS</sub>	±20	V
Maximum avalanche energy *1	E <sub>AV</sub>	519.8	mJ
Maximum power dissipation(Tc=25°C)	P <sub>D</sub>	40	W
Operating and storage temperature range	T <sub>ch</sub>	+150	°C
	T <sub>stg</sub>	-55 to +150	°C

\*1 L=1.11mH, V<sub>cc</sub>= -24V

##### Electrical characteristics (Tc =25°C unless otherwise specified)

	Symbol	Test Conditions	Min.	Typ.	Max.	Units
	BV <sub>DSS</sub>	I <sub>D</sub> =1mA V <sub>GS</sub> =0V	-60			V
	V <sub>GS(th)</sub>	I <sub>D</sub> =1mA V <sub>DS</sub> =V <sub>GS</sub>	-1.0	-1.5	-2.5	V
Zero gate voltage drain current	I <sub>DSS</sub>	V <sub>DS</sub> = -60V V <sub>GS</sub> =0V	T <sub>ch</sub> =25°C	-10	-500	μA
			T <sub>ch</sub> =125°C	-0.2	-1.0	mA
	I <sub>GSS</sub>	V <sub>GS</sub> =±20V V <sub>DS</sub> =0V		10	100	nA
	R <sub>DS(on)</sub>	I <sub>D</sub> = -12.5A	V <sub>GS</sub> = -4V	80	110	mΩ
			V <sub>GS</sub> = -10V	45	60	mΩ
	g <sub>fs</sub>	I <sub>D</sub> =12.5A V <sub>DS</sub> = -25V	7.5	15.0		S
	C <sub>iss</sub>	V <sub>DS</sub> = -25V V <sub>GS</sub> =0V f=1MHz		2000	3000	pF
	C <sub>oss</sub>			700	1050	
	C <sub>rss</sub>			450	680	
	t <sub>d(on)</sub>	V <sub>CC</sub> = -30V R <sub>G</sub> =10 Ω I <sub>D</sub> = -25A V <sub>GS</sub> = -10V		15	25	ns
	t <sub>r</sub>			80	120	
	t <sub>d(off)</sub>			190	290	
	t <sub>f</sub>			90	140	
	I <sub>AV</sub>		L=100μH T <sub>ch</sub> =25°C	-25		
	V <sub>SD</sub>	I <sub>F</sub> =2I <sub>DR</sub> V <sub>GS</sub> =0V T <sub>ch</sub> =25°C		-2	-3	V
	t <sub>rr</sub>	I <sub>F</sub> =I <sub>DR</sub> V <sub>GS</sub> =0V		160		ns
	Q <sub>rr</sub>	-di/dt=100A/μs T <sub>ch</sub> =25°C		0.9		μC

#### Thermal characteristics

Item	Symbol	Min.	Typ.	Max.	Units
Thermal resistance	R <sub>th(ch-c)</sub>			3.125	°C/W
	R <sub>th(ch-a)</sub>			62.5	°C/W

#### Outline Drawings

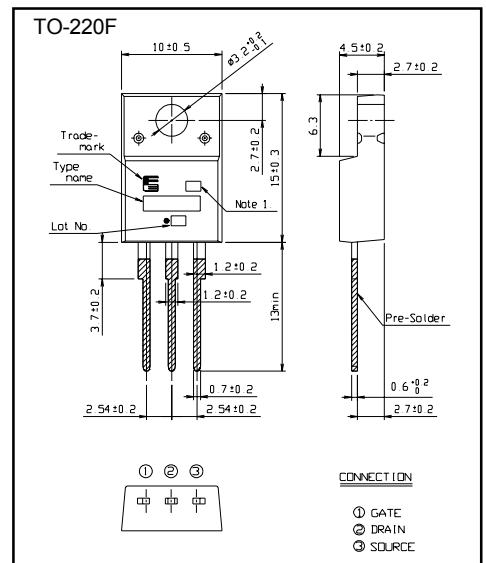

#### Equivalent circuit schematic

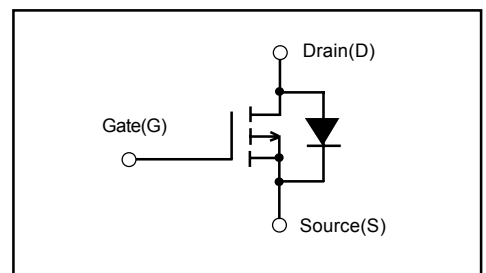

Characteristics

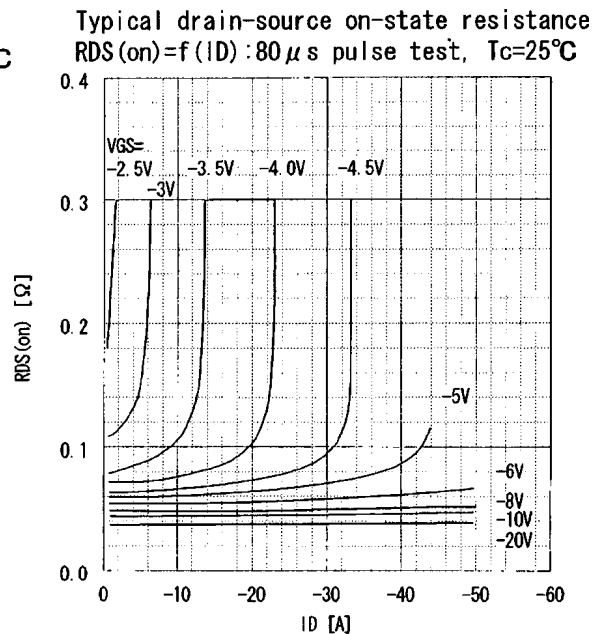
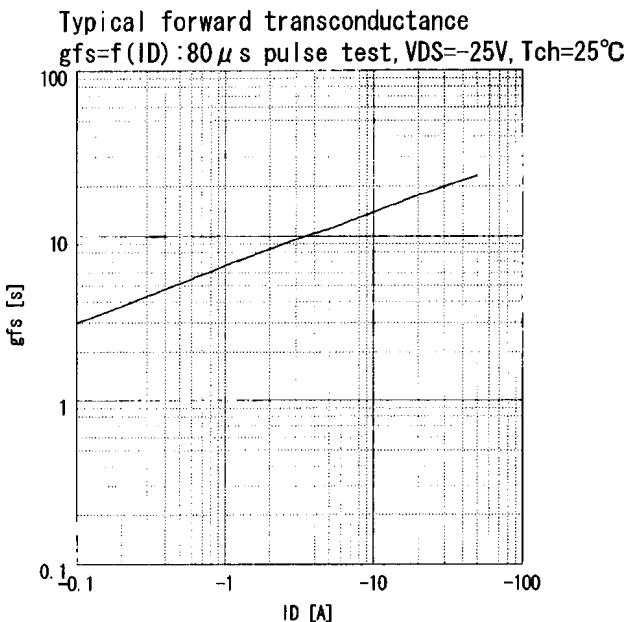
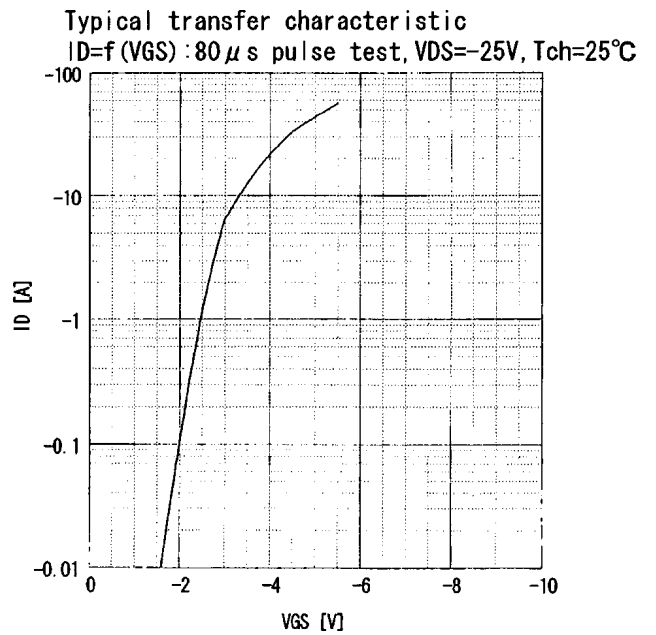
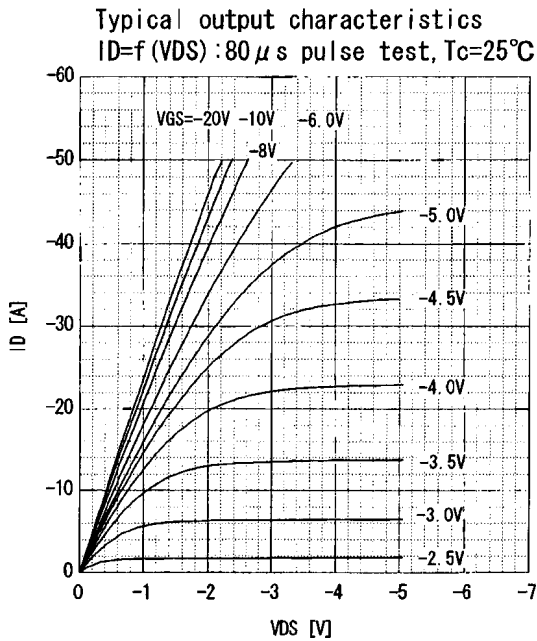
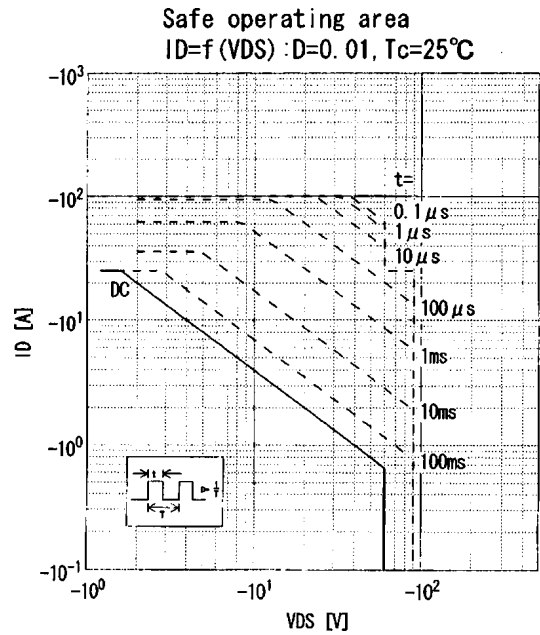
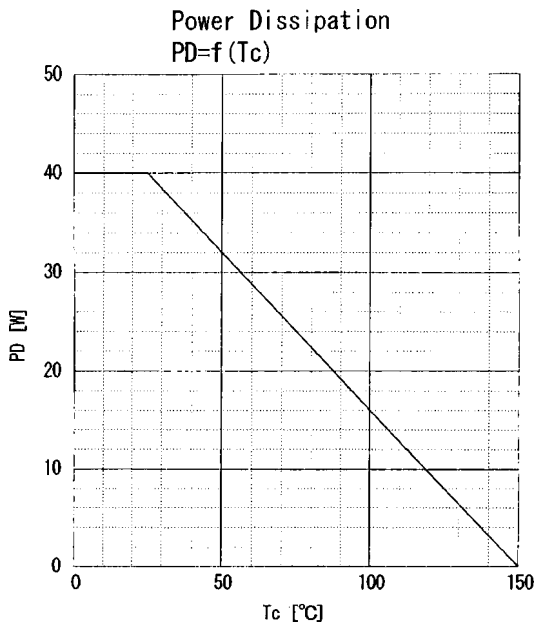

Drain-source on-state resistance  
 $R_{DS(on)} = f(T_{ch}) : I_D = -12.5A, V_{GS} = 10V$

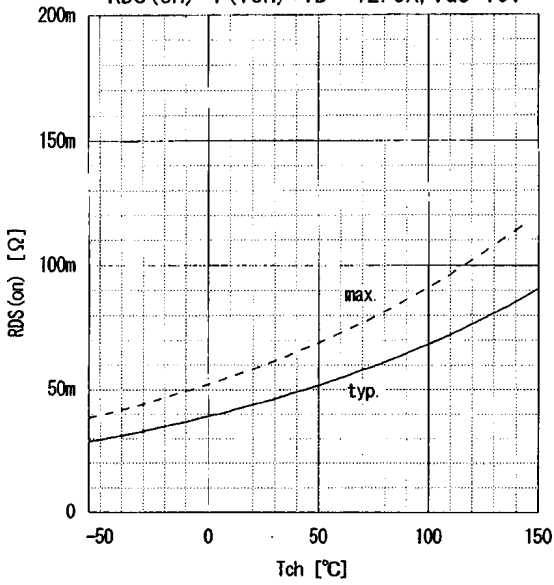

Gate threshold voltage  
 $V_{GS(th)} = f(T_{ch}) : I_D = -1mA, V_{DS} = V_{GS}$

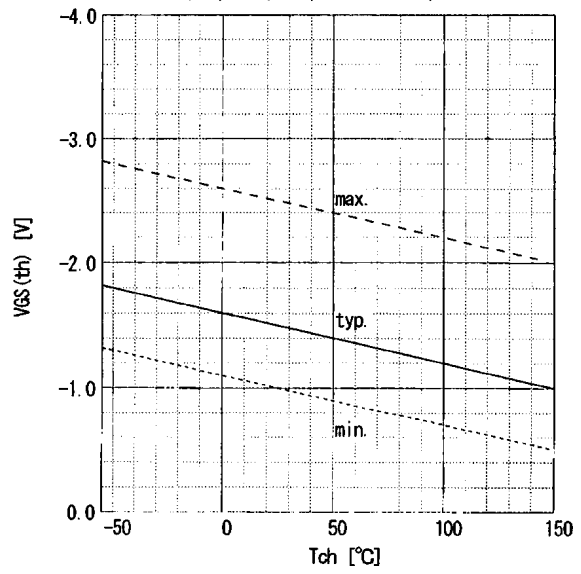

Typical gate charge characteristic  
 $V_{GS} = f(Q_g) : I_D = -25A, T_c = 25°C$

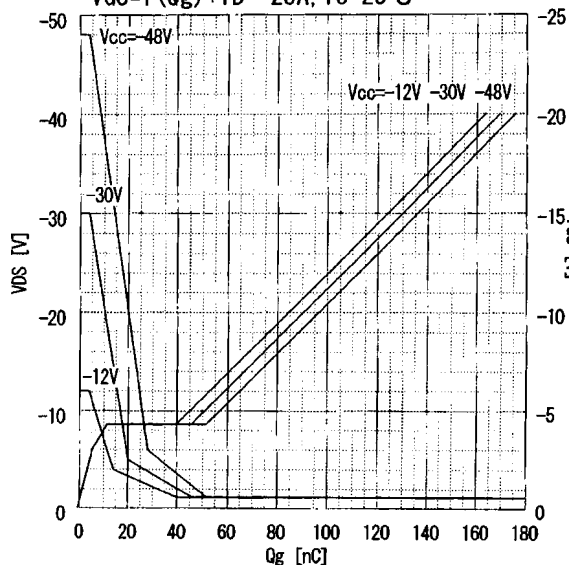

Typical capacitances  
 $C = f(V_{DS}) : V_{GS} = 0V, f = 1MHz$

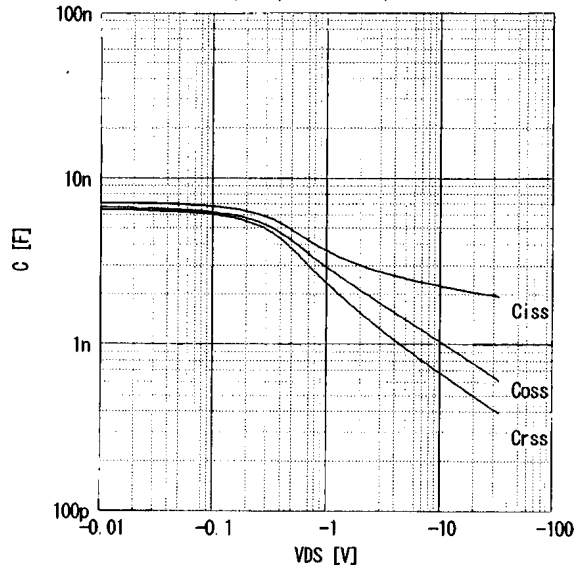

Maximum Avalanche Current vs. starting Tch  
 $I(AV) = f(\text{starting } Tch)$

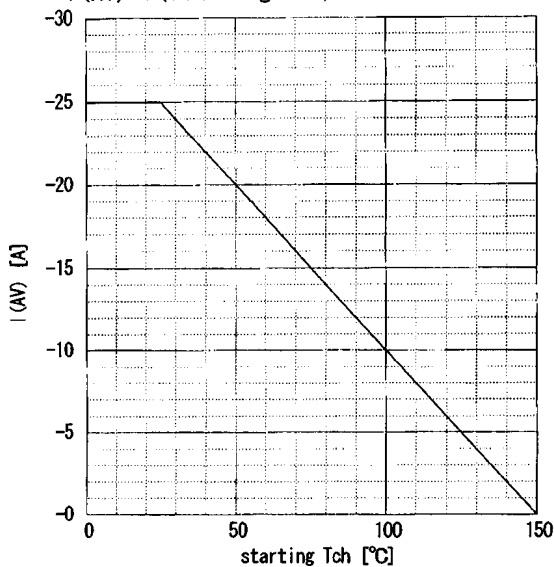

Maximum Avalanche Energy vs. starting Tch  
 $E(AV) = f(\text{starting } Tch) : V_{CC} = -24V, I(AV) \ge -25A$

