

N-CHANNEL SILICON POWER MOSFET

FAP-2S Series

Features

- High speed switching
- Low on-resistance
- No secondary breakdown
- Low driving power
- Avalanche-proof

Applications

- Switching regulators
- UPS (Uninterruptible Power Supply)
- DC-DC converters

Outline Drawings

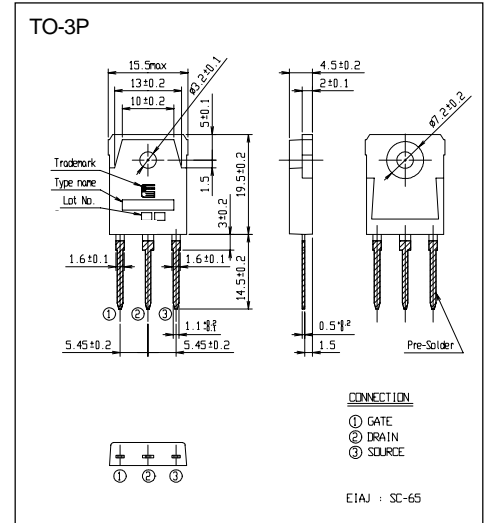

Maximum ratings and characteristic Absolute maximum ratings

(Tc=25°C unless otherwise specified)

Item	Symbol	Ratings	Unit
Drain-source voltage	V _{DS}	450	V
Continuous drain current	I _D	±10	A
Pulsed drain current	I _{D(puls)}	±40	A
Gate-source voltage	V _{GS}	±35	V
Repetitive or non-repetitive	IAR*2	10	A
Maximum Avalanche Energy	EAS*1	225	mJ
Max. power dissipation	P _D	100	W
Operating and storage temperature range	T _{ch} T _{stg}	+150 -55 to +150	°C °C

*1 L=4.70mH, V_{CC}=45V *2 T_{ch}≥150°C

Equivalent circuit schematic

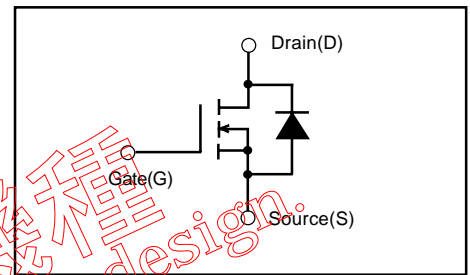

Electrical characteristics (Tc =25°C unless otherwise specified)

Item	Symbol	Test Conditions	Min.	Typ.	Max.	Units
Drain-source breakdown voltage	V _{(BR)DSS}	I _D =1mA V _{GS} =0V	450			V
Gate threshold voltage	V _{GS(th)}	I _D =1mA V _{DS} =V _{GS}	3.5	4.0	4.5	V
Zero gate voltage drain current	I _{DSS}	V _{DS} =450V V _{GS} =0V		10	500	μA
		V _{GS} =0V		0.2	1.0	mA
Gate-source leakage current	I _{GSS}	V _{GS} =±35V V _{DS} =0V		10	100	nA
Drain-source on-state resistance	R _{DS(on)}	I _D =5A V _{GS} =10V		0.58	0.65	Ω
Forward transconductance	g _{fs}	I _D =5A V _{DS} =25V	3	6		S
Input capacitance	C _{iss}	V _{DS} =25V		950	1450	pF
Output capacitance	C _{oss}	V _{GS} =0V		180	270	pF
Reverse transfer capacitance	C _{rss}	f=1MHz		80	120	pF
Turn-on time t _{on}	td(on)	V _{CC} =300V I _D =10A		25	40	ns
	t _r	V _{GS} =10V		70	110	
Turn-off time t _{off}	td(off)	R _{GS} =10Ω		70	110	ns
	t _f			50	80	
Avalanche capability	I _{AV}	L=100μH T _{ch} =25°C	10			A
Diode forward on-voltage	V _{SD}	I _F =2I _{DR} V _{GS} =0V T _{ch} =25°C		1.1	1.65	V
Reverse recovery time	t _{rr}	I _F =I _{DR} V _{GS} =0V		400		ns
Reverse recovery charge	Q _{rr}	-di/dt=100A/μs T _{ch} =25°C		5.0		μC

Thermal characteristics

Item	Symbol	Test Conditions	Min.	Typ.	Max.	Units
Thermal resistance	R _{th(ch-c)}	channel to case			1.25	°C/W
	R _{th(ch-a)}	channel to ambient			35.0	°C/W

Characteristics

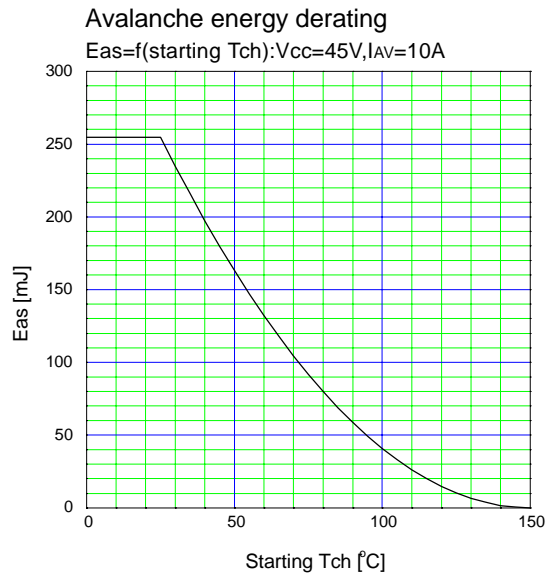
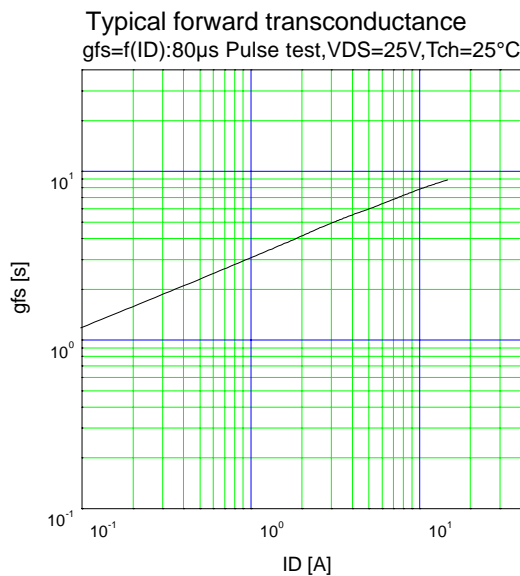
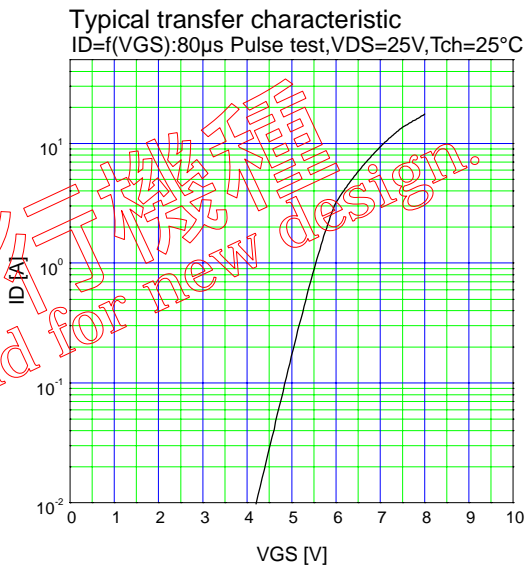
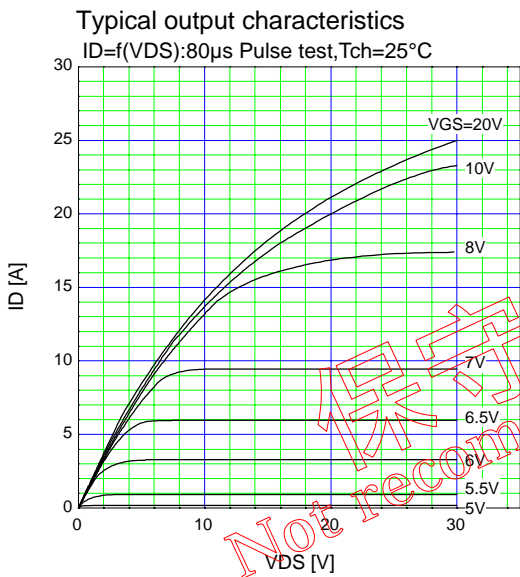
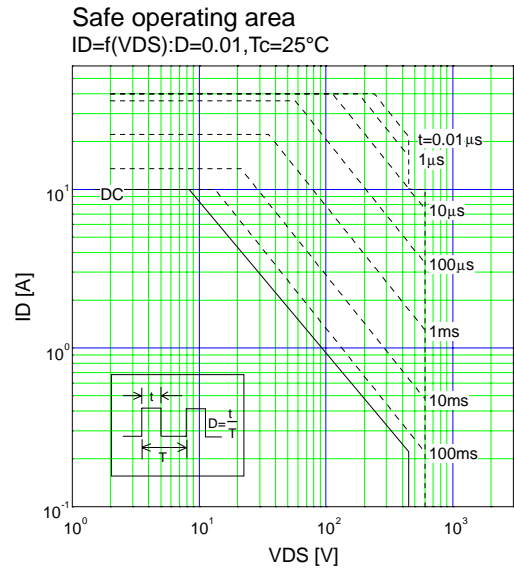
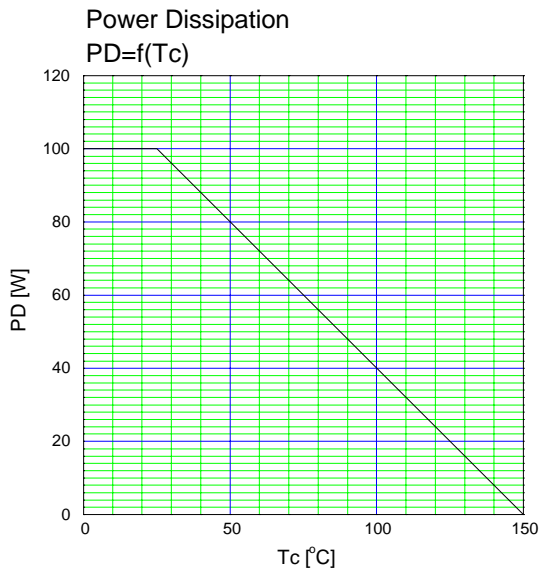

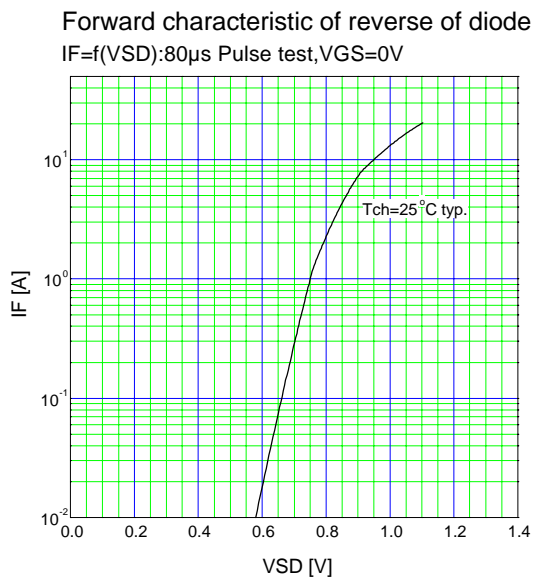
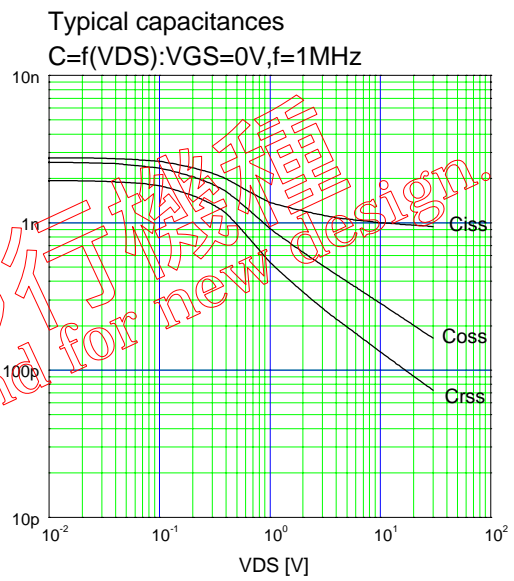
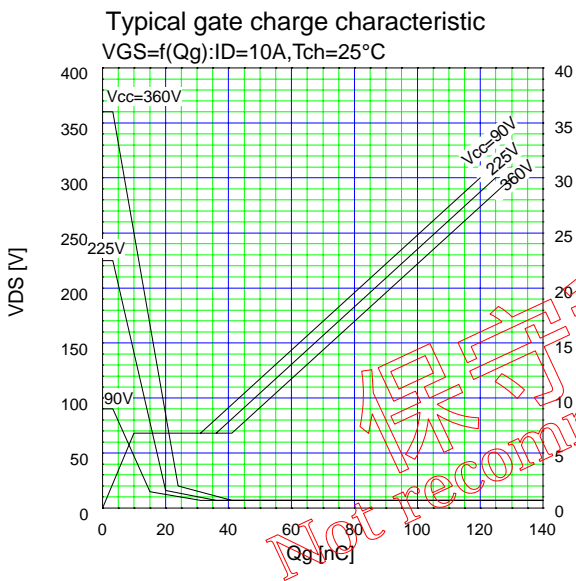
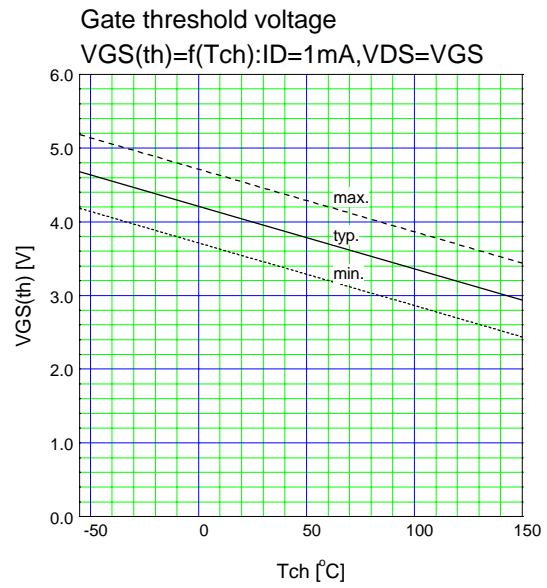
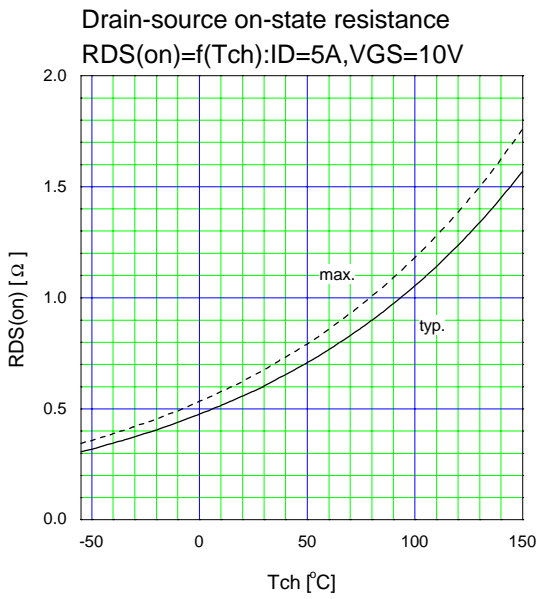

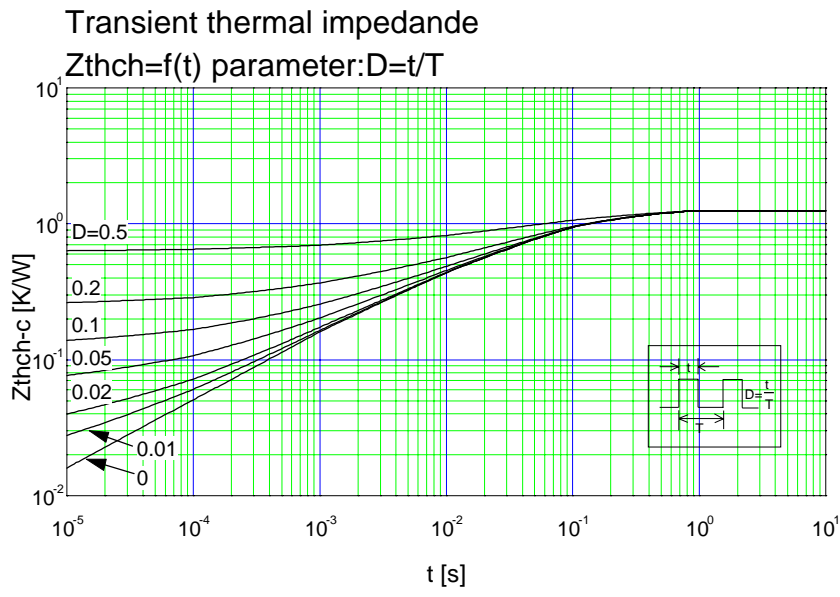

保守移行機種
Not recommend for new design.