

N-CHANNEL SILICON POWER MOSFET

FAP-IIS SERIES

Features

- High speed switching
- Low on-resistance
- No secondary breakdown
- Low driving power
- High voltage
- $V_{GS} = \pm 35V$ Guarantee
- Avalanche-proof

Applications

- Switching regulators
- UPS
- DC-DC converters
- General purpose power amplifier

Outline Drawings

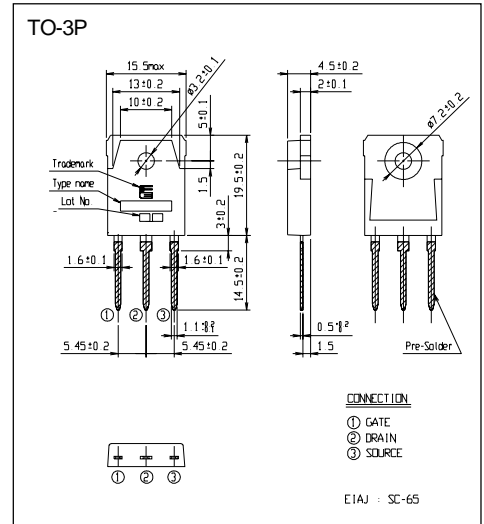

Maximum ratings and characteristics

Absolute maximum ratings ($T_c = 25^\circ C$ unless otherwise specified)

Item	Symbol	Rating	Unit	Remarks
Drain-source voltage	V_{DS}	500	V	
Continuous drain current	I_D	± 18	A	
Pulsed drain current	$I_{D[puls]}$	± 72	A	
Gate-source peak voltage	V_{GS}	± 35	V	
Repetitive or non-repetitive	I_{AV}	18	A	$R_{ch} \leq 150^\circ C$
Maximum avalanche energy	E_{AV}	518.5	μJ	
Maximum power dissipation	P_D	125	W	
Operating and storage temperature range	T_{ch} T_{stg}	+150 -55 to +150	$^\circ C$	

Equivalent circuit schematic

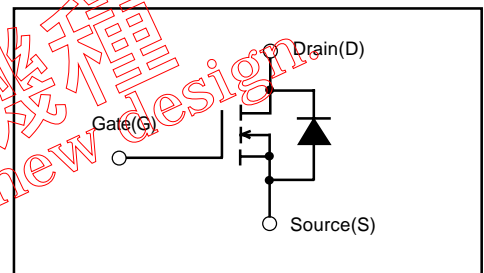

Electrical characteristics ($T_c = 25^\circ C$ unless otherwise specified)

Item	Symbol	Test Conditions	Min.	Typ.	Max.	Units	
Drain-source breakdown voltage	$V_{(BR)DSS}$	$I_D = 1mA$ $V_{GS} = 0V$	500			V	
Gate threshold voltage	$V_{GS(th)}$	$I_D = 1mA$ $V_{DS} = V_{GS}$	3.5	4.0	4.5	V	
Zero gate voltage drain current	I_{DSS}	$V_{DS} = 500V$ $V_{GS} = 0V$	$T_{ch} = 25^\circ C$		10	500	μA
			$T_{ch} = 125^\circ C$		0.2	1.0	mA
Gate-source leakage current	I_{GSS}	$V_{GS} = \pm 35V$ $V_{DS} = 0V$		10	100	nA	
Drain-source on-state resistance	$R_{DS(on)}$	$I_D = 9A$ $V_{GS} = 10V$		0.38	0.45	Ω	
Forward transconductance	g_{fs}	$I_D = 9A$ $V_{DS} = 25V$	5.5	11		S	
Input capacitance	C_{iss}	$V_{DS} = 25V$		1700	2600	pF	
Output capacitance	C_{oss}	$V_{GS} = 0V$		280	420		
Reverse transfer capacitance	C_{rss}	$f = 1MHz$		120	180		
Turn-on time	$t_{d(on)}$	$V_{CC} = 300V$ $R_G = 10\Omega$		20	30	ns	
	t_r	$I_D = 18A$		100	150		
Turn-off time	$t_{d(off)}$	$V_{GS} = 10V$		110	165		
	t_f			65	100		
Avalanche capability	I_{AV}	$L = 2.93mH$ $T_{ch} = 25^\circ C$	18			A	
Diode forward on-voltage	V_{SD}	$I_F = 2 \times I_{DR}$ $V_{GS} = 0V$ $T_{ch} = 25^\circ C$		1.1	1.65	V	
Reverse recovery time	t_{rr}	$I_F = I_{DR}$ $V_{GS} = 0V$		620		ns	
Reverse recovery charge	Q_{rr}	$-di/dt = 100A/\mu s$ $T_{ch} = 25^\circ C$		9.0		μC	

Thermal characteristics

Item	Symbol	Min.	Typ.	Max.	Units
Thermal resistance	$R_{th(ch-c)}$			1.0	$^\circ C/W$
	$R_{th(ch-a)}$			35.0	$^\circ C/W$

Characteristics

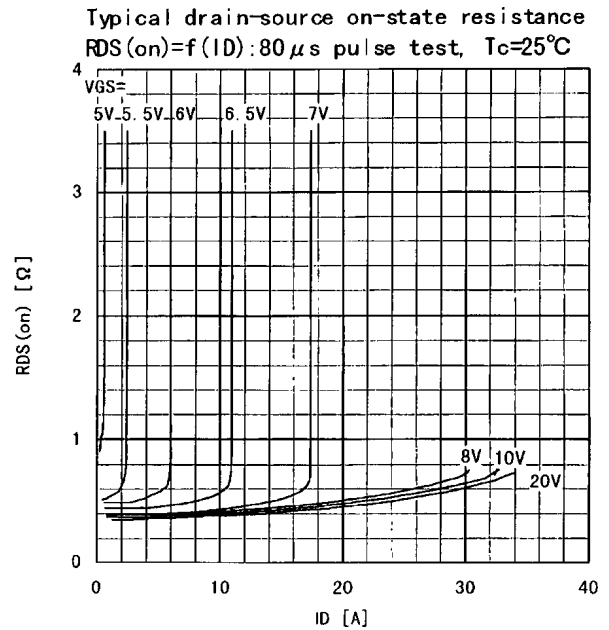
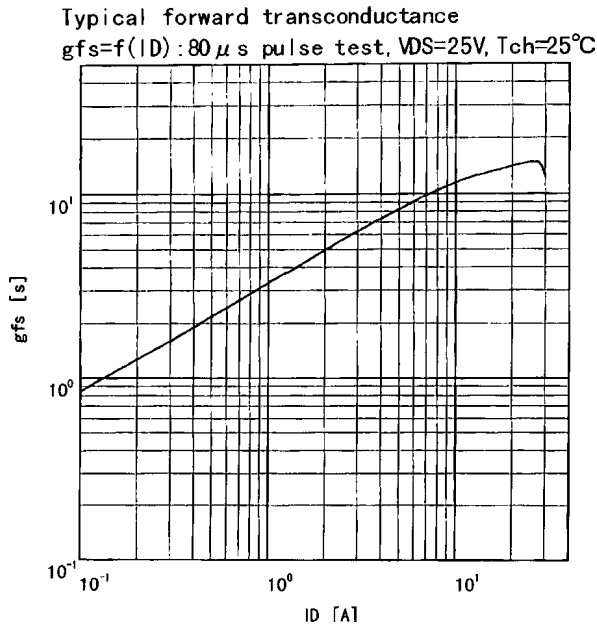
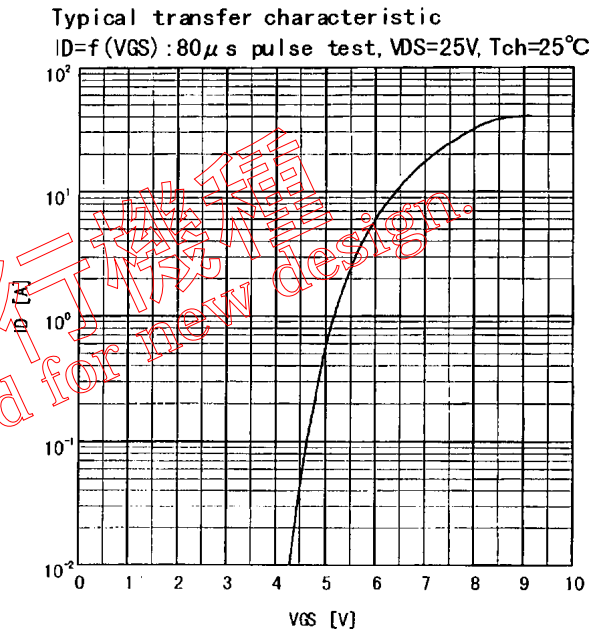
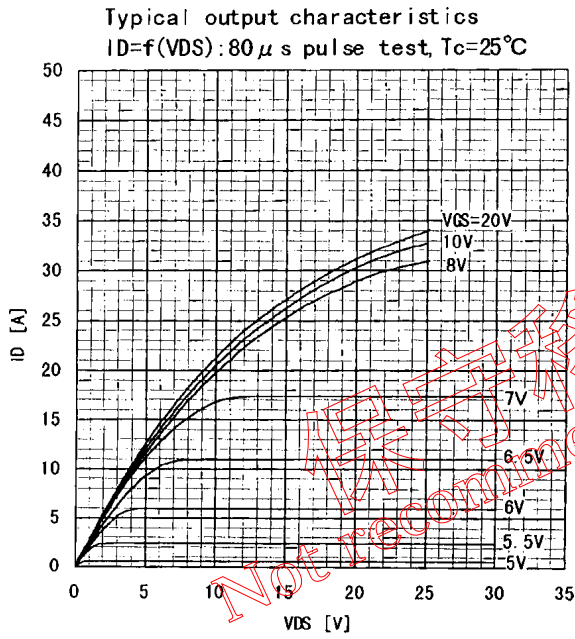
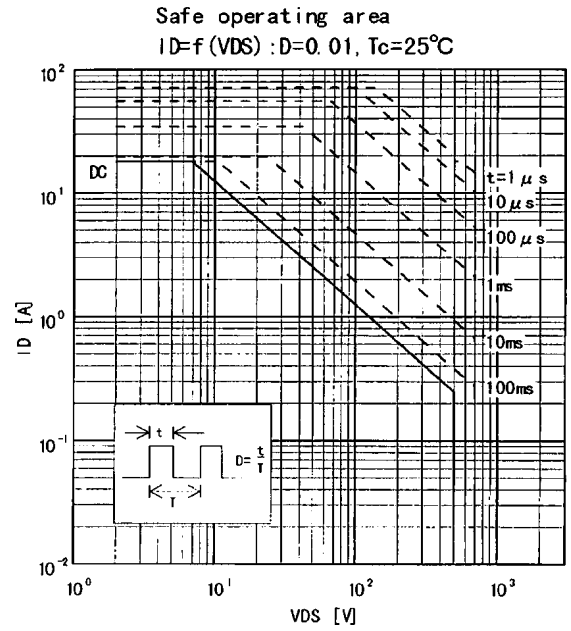
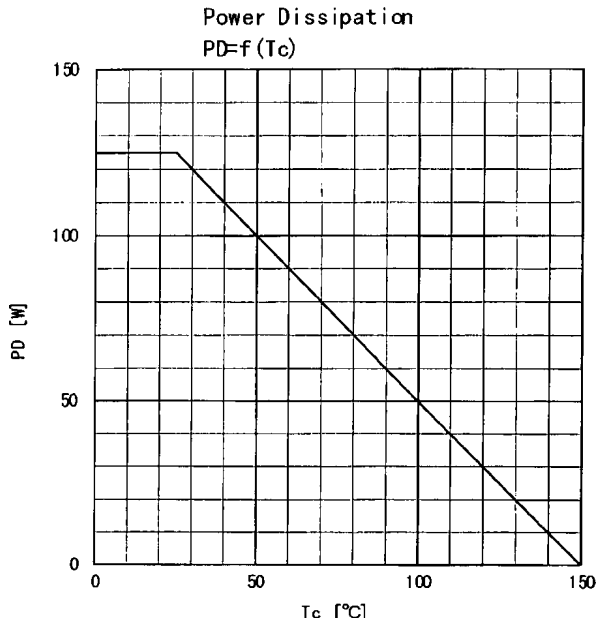

Drain-source on-state resistance
 $R_{DS(on)} = f(T_{ch}) : I_D = 9A, V_{GS} = 10V$

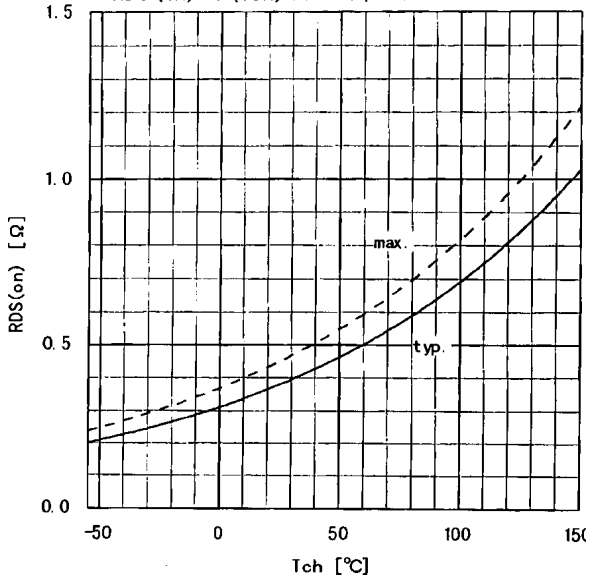

Gate threshold voltage
 $V_{GS(th)} = f(T_{ch}) : I_D = 1mA, V_{DS} = V_{GS}$

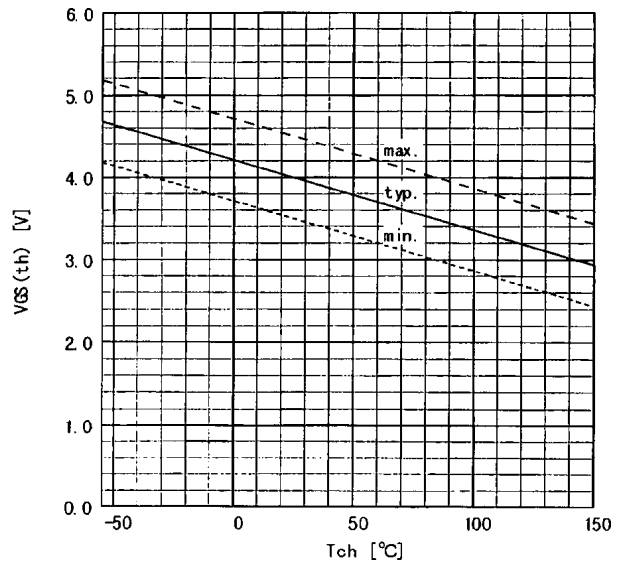

Typical gate charge characteristic
 $V_{GS} = f(Q_g) : I_D = 18A, T_c = 25°C$

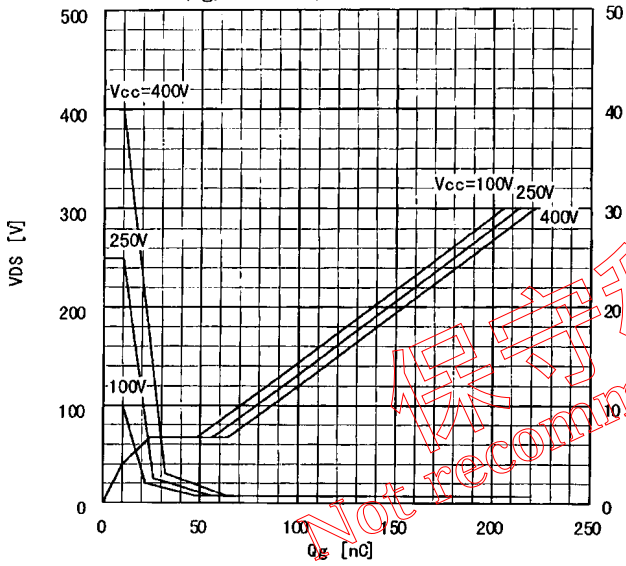

Typical capacitances
 $C = f(V_{DS}) : V_{GS} = 0V, f = 1MHz$

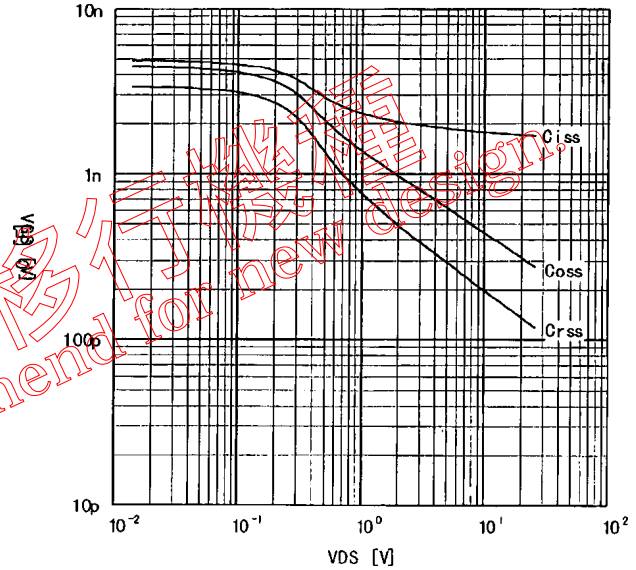

Forward characteristic of reverse of diode
 $I_F = f(V_{SD}) : 80 \mu s \text{ pulses test}, V_{GS} = 0V$

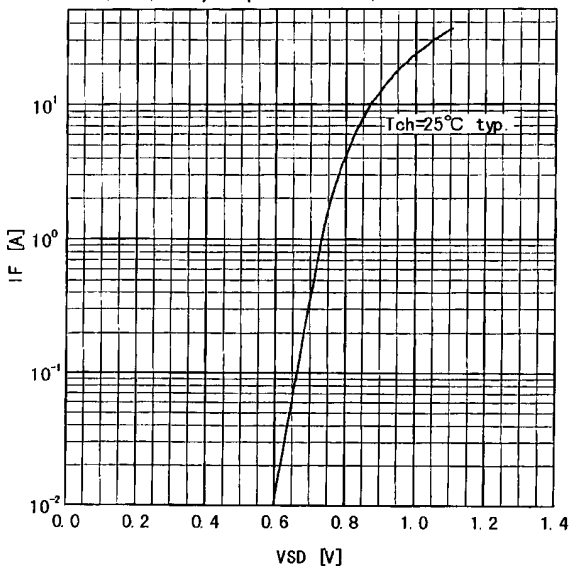

Avalanche energy derating
 $E_{as} = f(\text{starting } T_{ch}) : V_{CC} = 50V, I_{AV} = 18A$

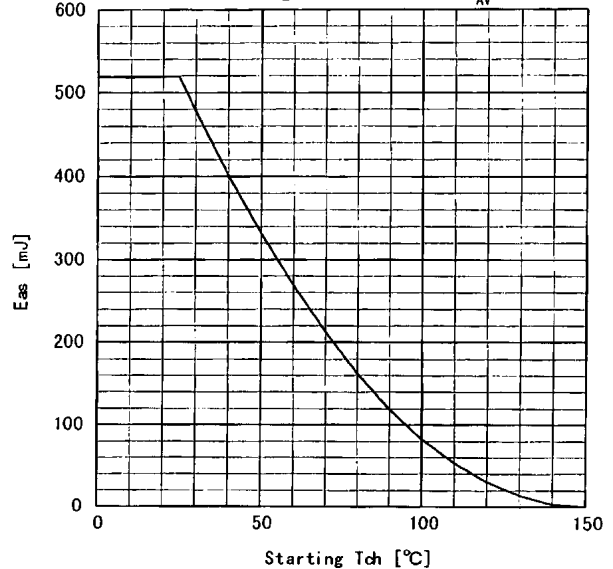

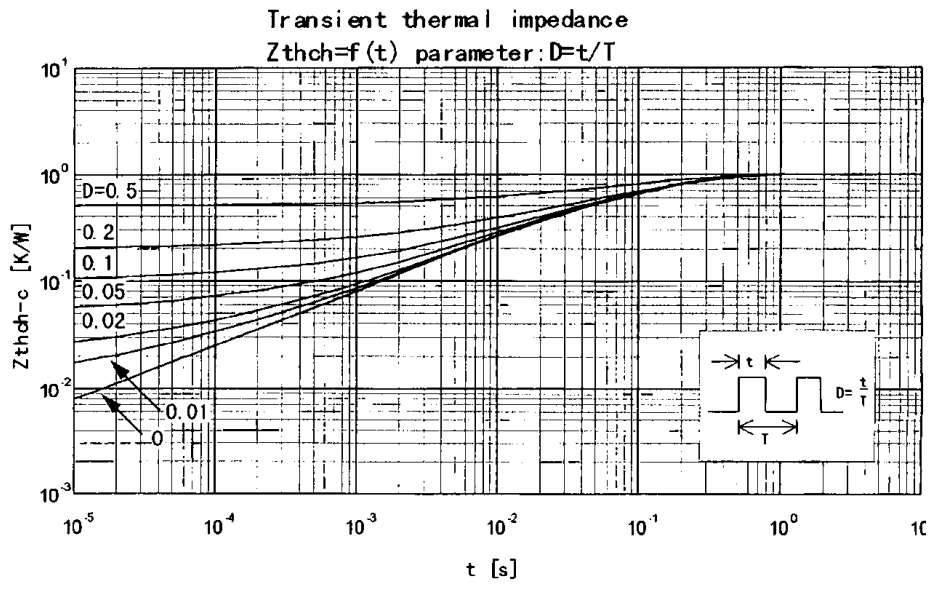

保守移行機種
Not recommend for new design.