

## N-CHANNEL SILICON POWER MOSFET

### FAP-2S Series

#### Features

- High speed switching
- Low on-resistance
- No secondary breakdown
- Low driving power
- Avalanche-proof

#### Applications

- Switching regulators
- UPS (Uninterruptible Power Supply)
- DC-DC converters

#### Outline Drawings

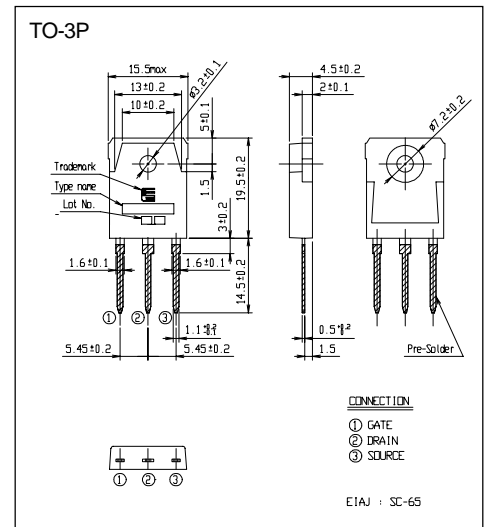

#### Maximum ratings and characteristic Absolute maximum ratings

(T<sub>c</sub>=25°C unless otherwise specified)

Item	Symbol	Ratings	Unit
Drain-source voltage	V <sub>DS</sub>	600	V
Continuous drain current	I <sub>D</sub>	±9	A
Pulsed drain current	I <sub>D(puls)</sub>	±32	A
Gate-source voltage	V <sub>GS</sub>	±35	V
Repetitive or non-repetitive	IAR*2	9	A
Maximum Avalanche Energy	EAS*1	162.3	mJ
Max. power dissipation	P <sub>D</sub>	80	W
Operating and storage temperature range	T <sub>ch</sub> T <sub>stg</sub>	+150 -55 to +150	°C °C

\*1 L=3.67mH, V<sub>CC</sub>=60V \*2 T<sub>ch</sub>≥150°C

#### Equivalent circuit schematic

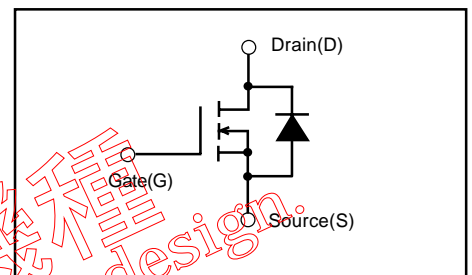

#### Electrical characteristics (T<sub>c</sub> =25°C unless otherwise specified)

Item	Symbol	Test Conditions	Min.	Typ.	Max.	Units
Drain-source breakdown voltage	V <sub>(BR)DSS</sub>	I <sub>D</sub> =1mA V <sub>GS</sub> =0V	600			V
Gate threshold voltage	V <sub>GS(th)</sub>	I <sub>D</sub> =1mA V <sub>DS</sub> =V <sub>GS</sub>	3.5	4.0	4.5	V
Zero gate voltage drain current	I <sub>DSS</sub>	V <sub>DS</sub> =600V		10	500	μA
		V <sub>GS</sub> =0V		0.2	1.0	mA
Gate-source leakage current	I <sub>GSS</sub>	V <sub>GS</sub> =±35V V <sub>DS</sub> =0V		10	100	nA
Drain-source on-state resistance	R <sub>DS(on)</sub>	I <sub>D</sub> =4.5A V <sub>GS</sub> =10V		1.0	1.2	Ω
Forward transconductance	g <sub>fs</sub>	I <sub>D</sub> =4.5A V <sub>DS</sub> =25V	2.5	5.0		S
Input capacitance	C <sub>iss</sub>	V <sub>DS</sub> =25V		900	1400	pF
Output capacitance	C <sub>oss</sub>	V <sub>GS</sub> =0V		150	230	pF
Reverse transfer capacitance	C <sub>rss</sub>	f=1MHz		70	110	pF
Turn-on time t <sub>on</sub>	td(on)	V <sub>CC</sub> =300V I <sub>D</sub> =9A		25	40	ns
	t <sub>r</sub>	V <sub>GS</sub> =10V		70	110	
Turn-off time t <sub>off</sub>	td(off)	R <sub>GS</sub> =10 Ω		60	90	ns
	t <sub>f</sub>			35	60	
Avalanche capability	I <sub>AV</sub>	L=3.67 mH T <sub>ch</sub> =25°C	9			A
Diode forward on-voltage	V <sub>SD</sub>	I <sub>F</sub> =2I <sub>DR</sub> V <sub>GS</sub> =0V T <sub>ch</sub> =25°C		1.0	1.5	V
Reverse recovery time	t <sub>rr</sub>	I <sub>F</sub> =I <sub>DR</sub> V <sub>GS</sub> =0V		550		ns
Reverse recovery charge	Q <sub>rr</sub>	-di/dt=100A/μs T <sub>ch</sub> =25°C		7.0		μC

#### Thermal characteristics

Item	Symbol	Test Conditions	Min.	Typ.	Max.	Units
Thermal resistance	R <sub>th(ch-c)</sub>	channel to case			1.56	°C/W
	R <sub>th(ch-a)</sub>	channel to ambient			35.0	°C/W

Characteristics

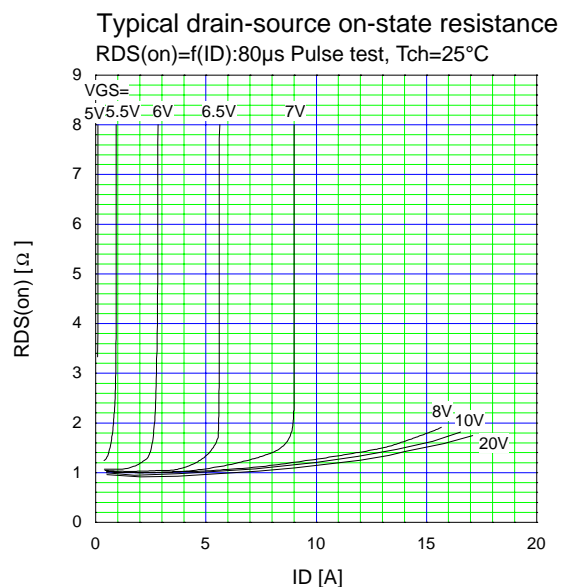
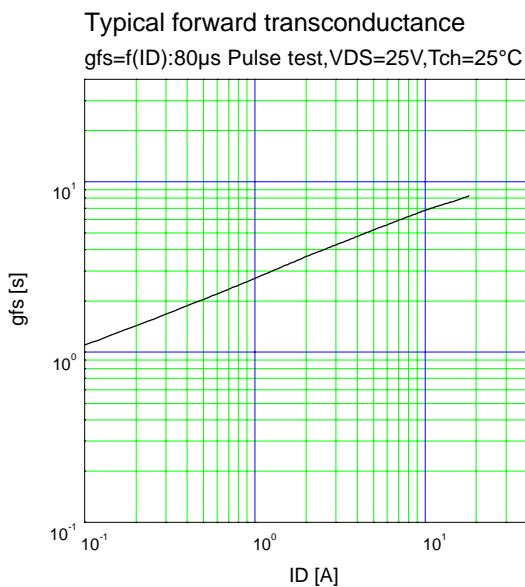
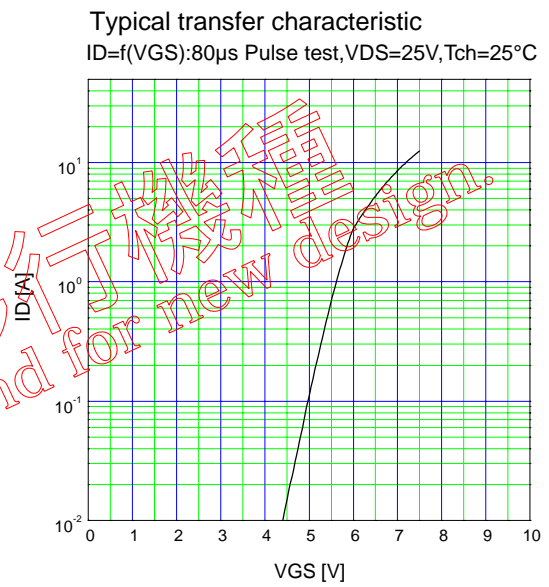
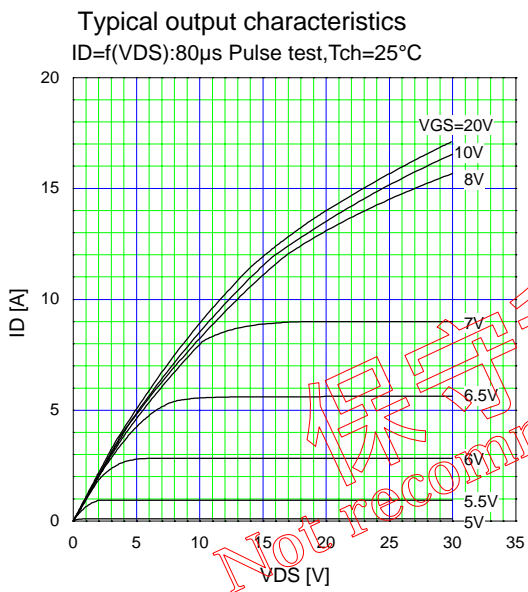
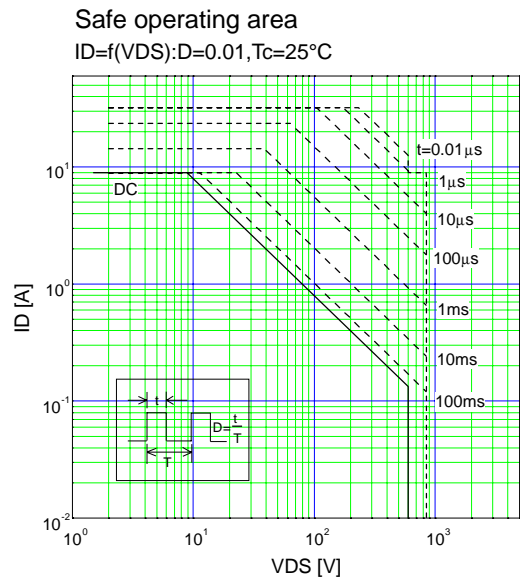
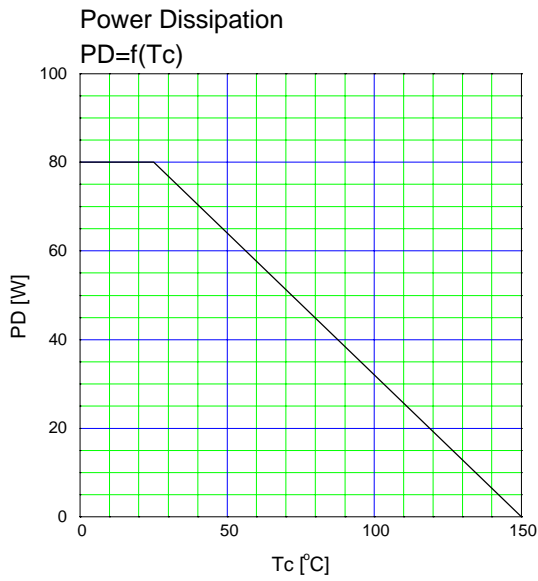

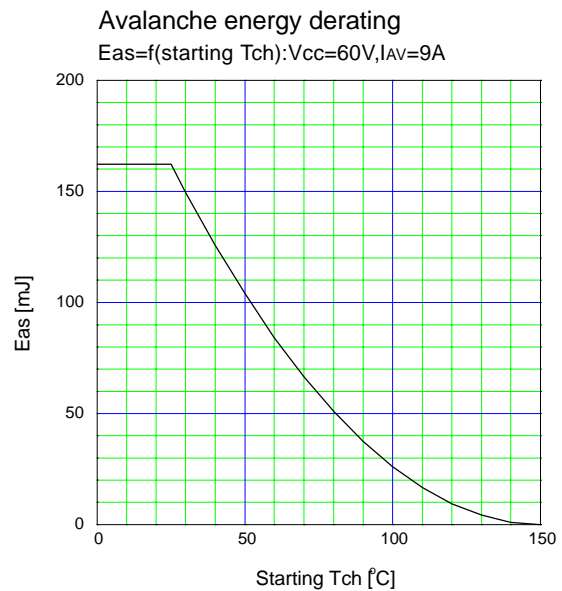
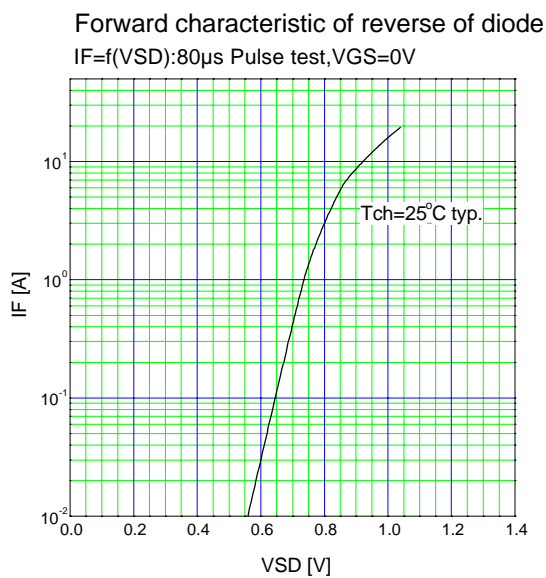
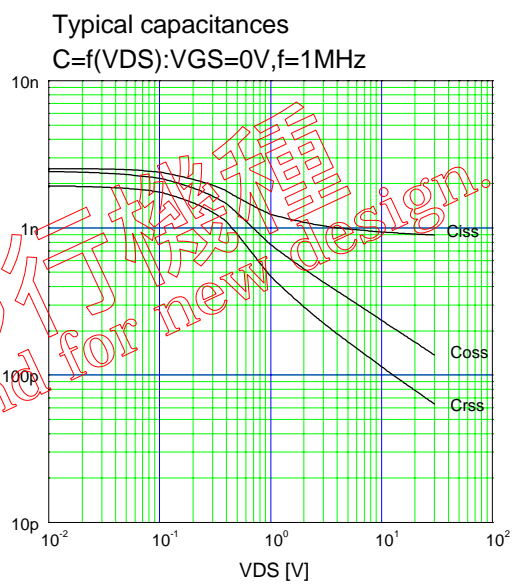
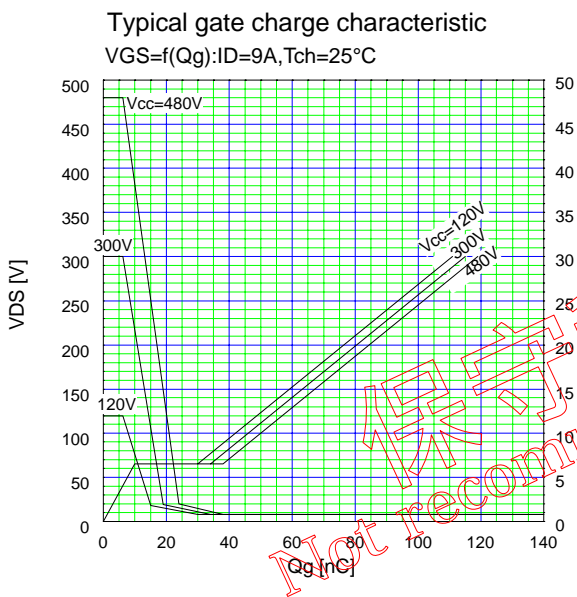
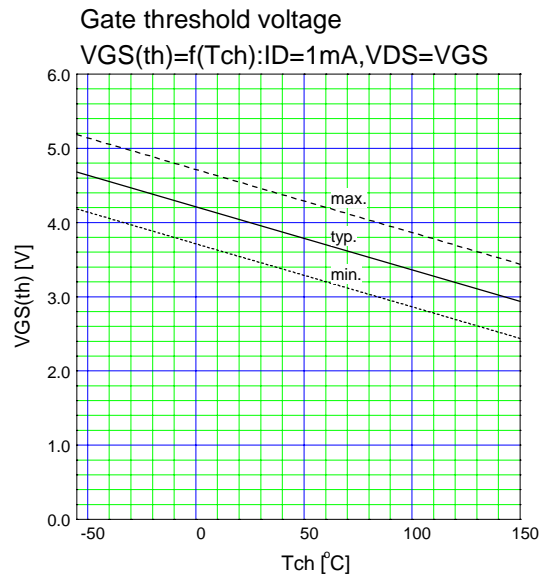
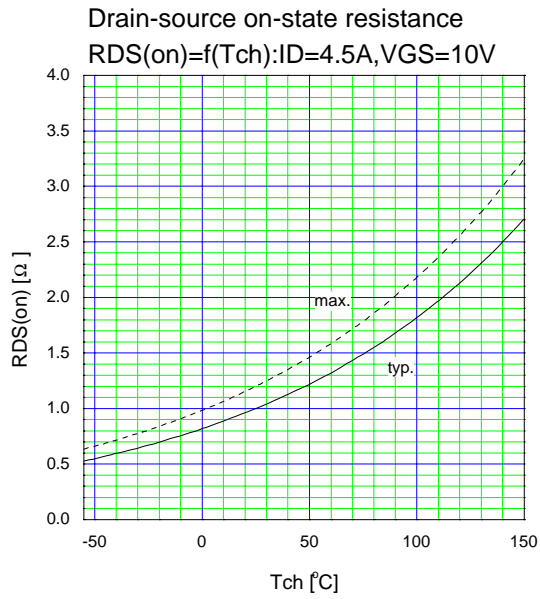

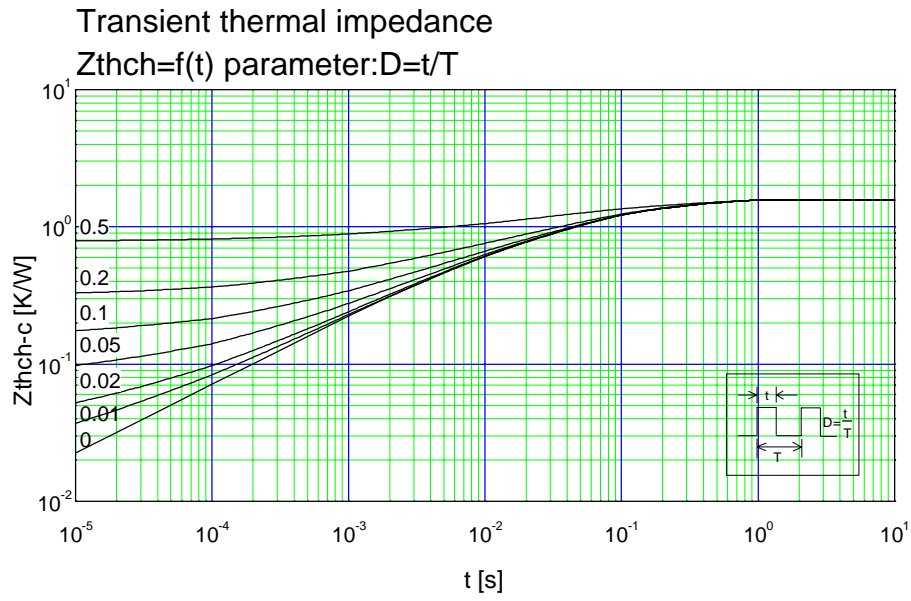

保守移行機種  
Not recommend for new design.