

N-CHANNEL SILICON POWER MOSFET

FAP-IIIB SERIES

■ Features

- High speed switching
- Low on-resistance
- No secondary breakdown
- Low driving power
- High voltage
- Avalanche-proof

■ Applications

- Switching regulators
- DC-DC converters
- General purpose power amplifier

■ Outline Drawings

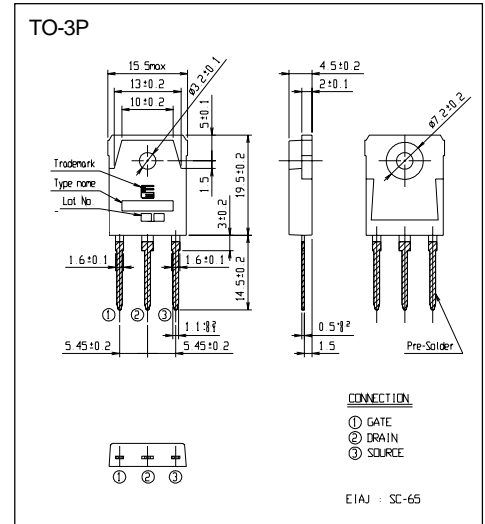

■ Maximum ratings and characteristics

● Absolute maximum ratings (T_c=25°C unless otherwise specified)

Item	Symbol	Rating	Unit	Remarks
Drain-source voltage	V _{DS}	30	V	
Continuous drain current	I _D	±100	A	
Pulsed drain current	I _D [puls]	±400	A	
Gate-source peak voltage	V _{GS}	±16	V	
Maximum avalanche energy	E _{AV}	2536.7	mJ	*1
Maximum power dissipation	P _D	150	W	
Operating and storage temperature range	T _{ch}	+150	°C	
	T _{stg}	-55 to +150	°C	

*1 L=0.338mH, V_{CC}=12V

■ Equivalent circuit schematic

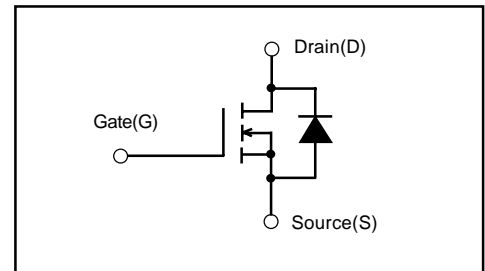

● Electrical characteristics (T_c =25°C unless otherwise specified)

Item	Symbol	Test Conditions	Min.	Typ.	Max.	Units	
Drain-source breakdown voltage	V _{(BR)DSS}	I _D =1mA V _{GS} =0V	30			V	
Gate threshold voltage	V _{GS(th)}	I _D =1mA V _{DS} =V _{GS}	1.0	1.5	2.0	V	
Zero gate voltage drain current	I _{DSS}	V _{DS} =30V V _{GS} =0V	T _{ch} =25°C		10	500	μA
			T _{ch} =125°C		0.2	1.0	mA
Gate-source leakage current	I _{GSS}	V _{GS} =±16V V _{DS} =0V		10	100	nA	
Drain-source on-state resistance	R _{DS(on)}	I _D =50A V _{GS} =10V	V _{GS} =4V		4.8	7.0	mΩ
			V _{GS} =10V		3.2	4.0	mΩ
Forward transconductance	g _{fs}	I _D =50A V _{DS} =25V	45	90		S	
Input capacitance	C _{iss}	V _{DS} =25V V _{GS} =0V f=1MHz		6600	9900	pF	
Output capacitance	C _{oss}			3300	4950		
Reverse transfer capacitance	C _{rss}			1400	2100		
Turn-on time	t _{d(on)}	V _{CC} =15V R _G =10 Ω I _D =100A		20	30	ns	
	t _r			150	230		
Turn-off time	t _{d(off)}	V _{GS} =10V		470	710		
	t _f			370	560		
Avalanche capability	I _{AV}	L=100μH T _{ch} =25°C	100			A	
Diode forward on-voltage	V _{SD}	I _F =100A V _{GS} =0V T _{ch} =25°C		1.0	1.5	V	
Reverse recovery time	t _{rr}	I _F =50A		95		ns	
Reverse recovery charge	Q _{rr}		-di/dt=100A/μs T _{ch} =25°C		0.22		μC

● Thermal characteristics

Item	Symbol	Min.	Typ.	Max.	Units
Thermal resistance	R _{th(ch-c)}			0.83	°C/W
	R _{th(ch-a)}			35.0	°C/W

Characteristics

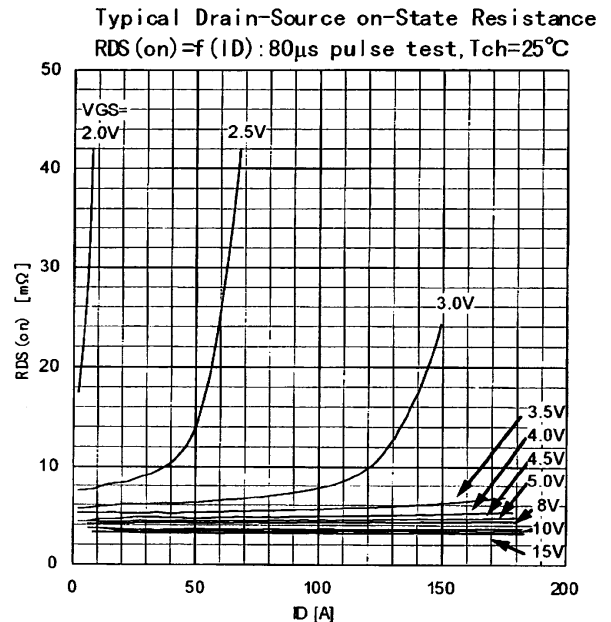
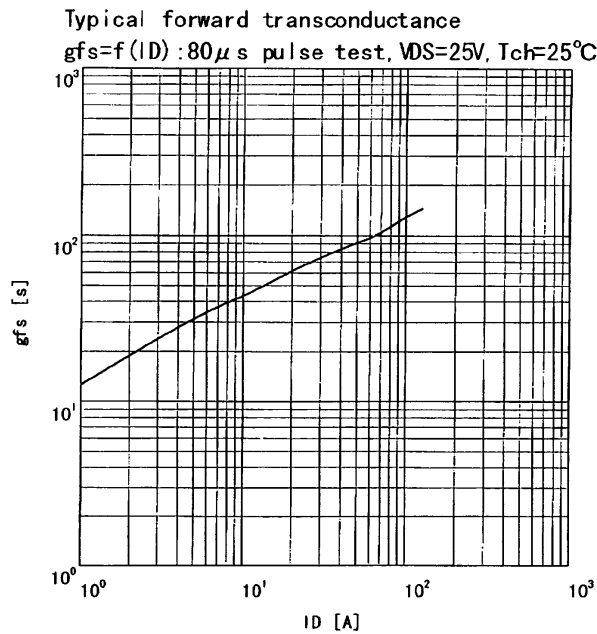
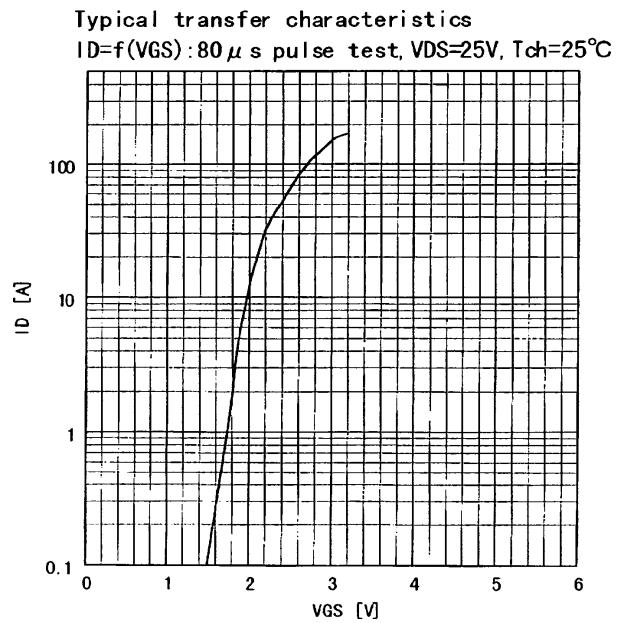
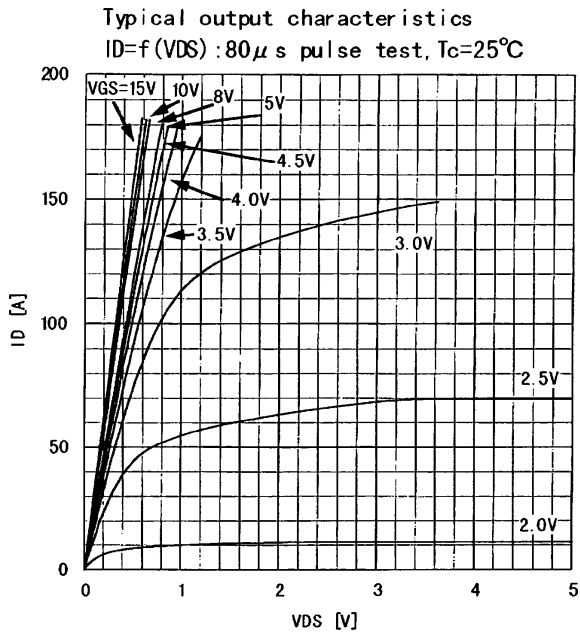
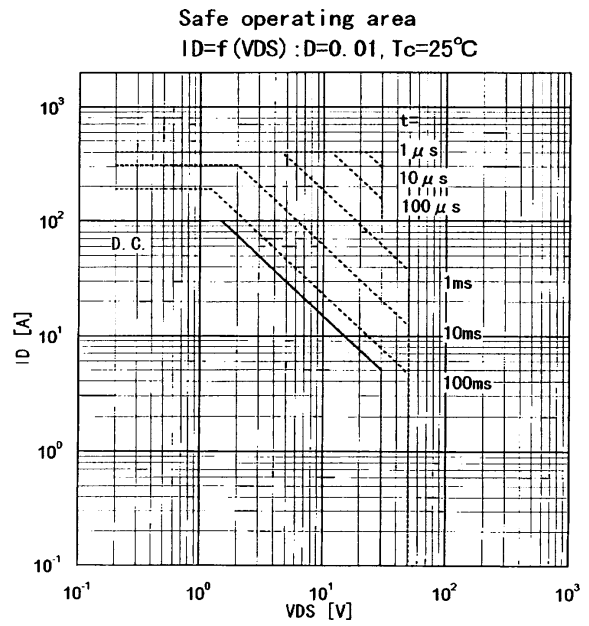
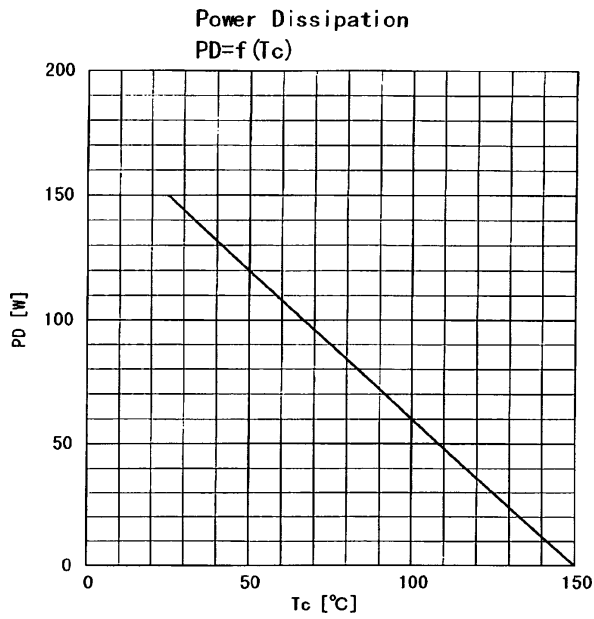

Drain-source on-state resistance
 $R_{DS(on)} = f(T_{ch}) : I_D = 50A, V_{GS} = 10V$

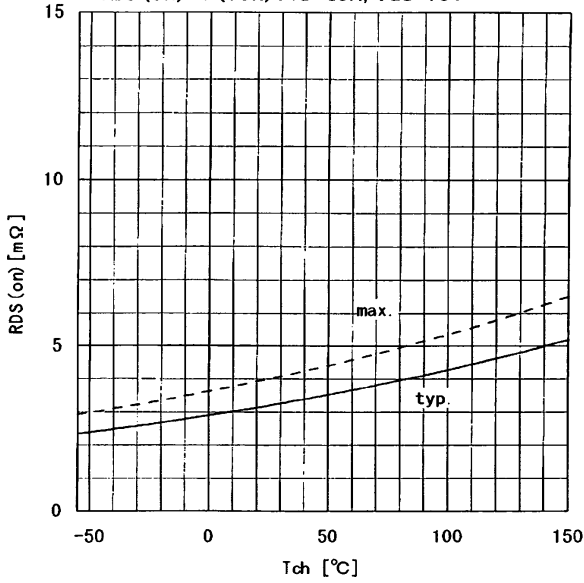

Gate Threshold Voltage vs. Tch
 $V_{GS(th)} = f(T_{ch}) : V_{DS} = V_{GS}, I_D = 1mA$

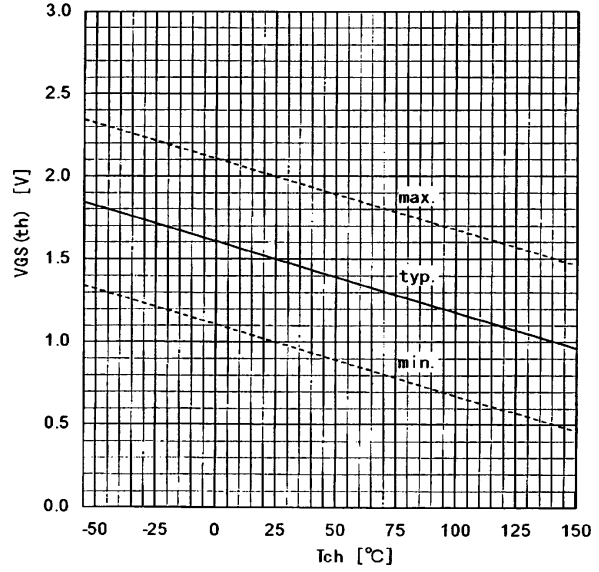

Typical Gate Charge Characteristics
 $V_{GS} = f(Q_g) : I_D = 100A, T_{ch} = 25°C$

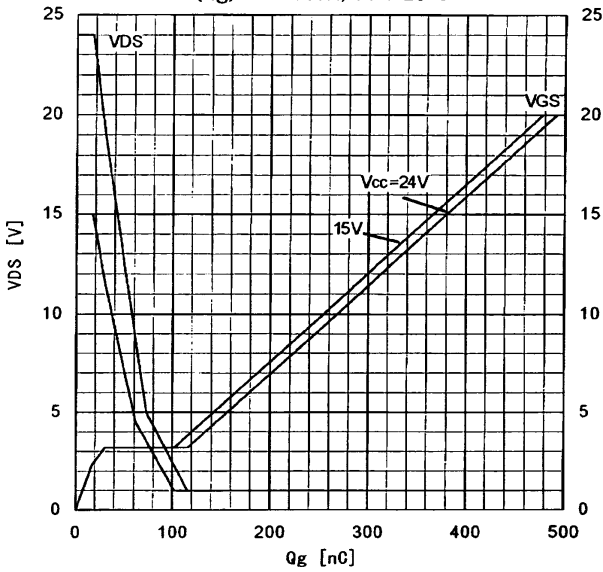

Typical capacitances
 $C = f(V_{DS}) : V_{GS} = 0V, f = 1MHz$

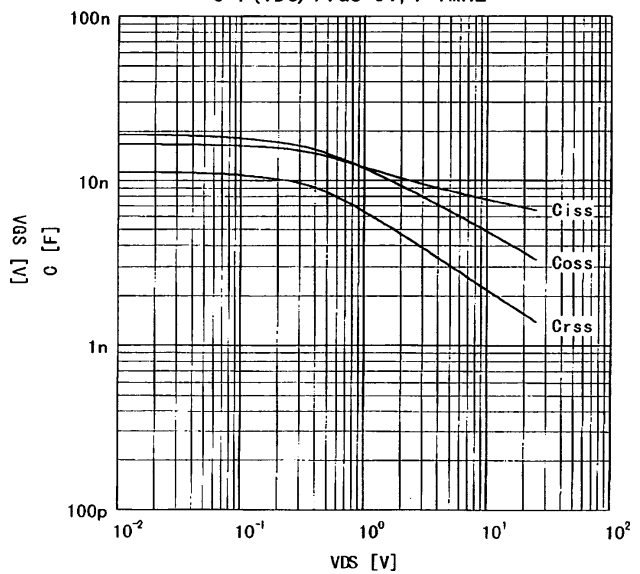

Typical Forward Characteristics of Reverse Diode
 $I_F = f(V_{SD}) : 80\mu s \text{ pulse test}, T_{ch} = 25°C$

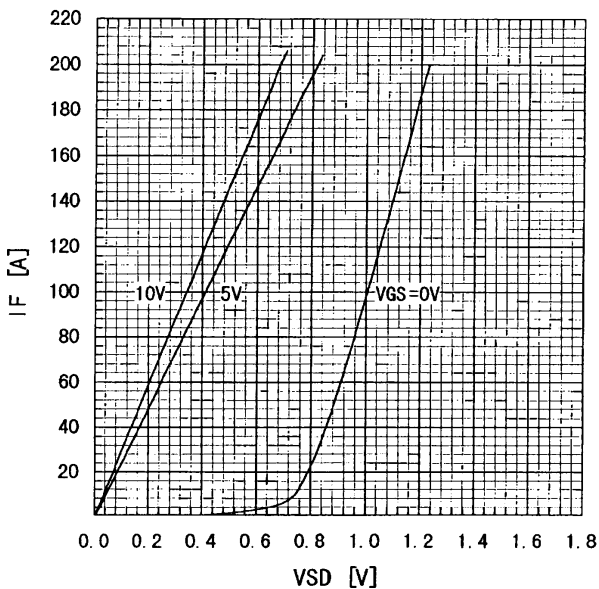

Typical Switching Characteristics vs. ID
 $t = f(I_D) : V_{CC} = 15V, V_{GS} = 10V, R_G = 10\Omega$

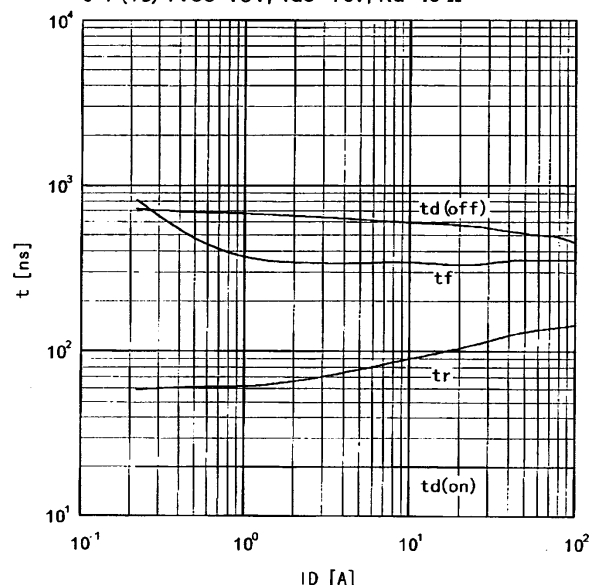

Maximum Avalanche Current vs. starting Tch
 $I_{AV} = f(\text{starting Tch})$

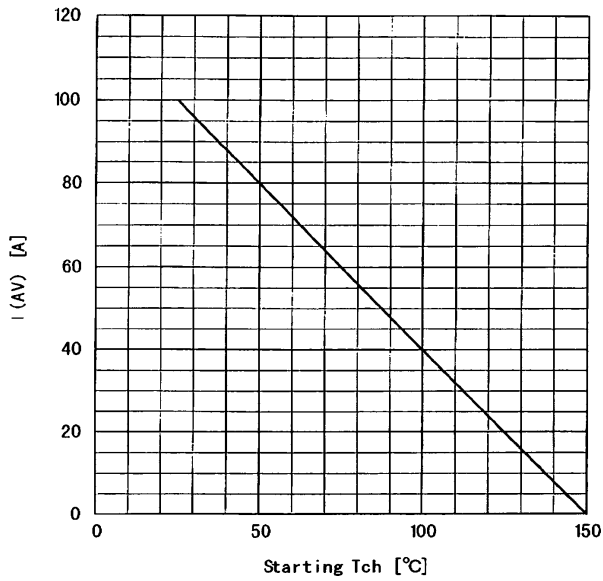

Maximum Avalanche energy vs. starting Tch
 $E_{as} = f(\text{starting Tch}) : V_{cc} = 12V, I_{AV} \leq 100A$

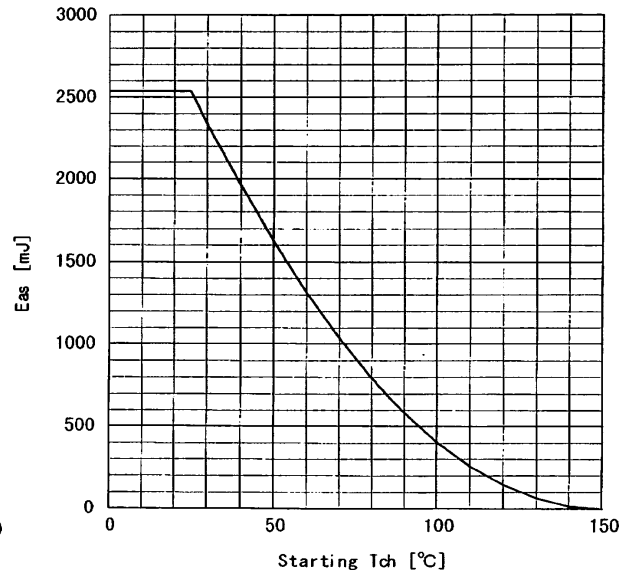

Transient thermal impedance
 $Z_{thch} = f(t)$ parameter: $D = t/T$

