

N-CHANNEL SILICON POWER MOSFET

FAP-IIS SERIES

Features

- High speed switching
- Low on-resistance
- No secondary breakdown
- Low driving power
- Avalanche-proof

Applications

- Switching regulators
- DC-DC converters
- General purpose power amplifier

Outline Drawings

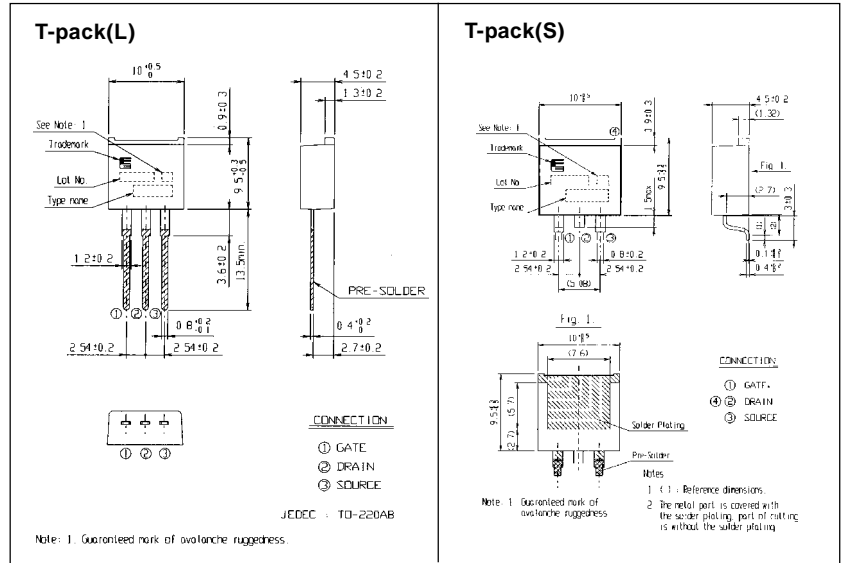

Maximum ratings and characteristics

Absolute maximum ratings (Tc=25°C unless otherwise specified)

Item	Symbol	Rating	Unit	Remarks
Drain-source voltage	V _{DS}	600	V	
Continuous drain current	I _D	±9	A	
Pulsed drain current	I _D [puls]	±32	A	
Gate-source peak voltage	V _{GS}	±35	V	
Repetitive or non-repetitive	I _{AR}	9	A	T _{ch} ≤ 150°C
Maximum avalanche energy	E _{AV}	144.4	mJ	*1
Maximum power dissipation	P _D	60	W	
Operating and storage temperature range	T _{ch} T _{stg}	+150 -55 to +150	°C	

*1 L=3.27mH, V_{cc}=60V

Equivalent circuit schematic

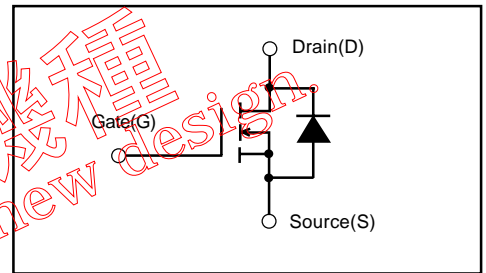

Electrical characteristics (Tc = 25°C unless otherwise specified)

Item	Symbol	Test Conditions	Min.	Typ.	Max.	Units	
Drain-source breakdown voltage	V(BR)DSS	I _D =1mA V _{GS} =0V	600			V	
Gate threshold voltage	V _{GS(th)}	I _D =1mA V _{DS} =V _{GS}	3.5	4.0	4.5	V	
Zero gate voltage drain current	I _{DSS}	V _{DS} =600V V _{GS} =0V	T _{ch} =25°C		10	500	μA
			T _{ch} =125°C		0.2	1.0	mA
Gate-source leakage current	I _{GSS}	V _{GS} =±35V V _{DS} =0V		10	100	nA	
Drain-source on-state resistance	R _{DS(on)}	I _D =4.5A V _{GS} =10V		1.0	1.2	Ω	
Forward transconductance	g _{fs}	I _D =4.5A V _{DS} =25V	2.5	5.0		S	
Input capacitance	C _{iss}	V _{DS} =25V		900	1400	pF	
Output capacitance	C _{oss}	V _{GS} =0V		150	230		
Reverse transfer capacitance	C _{rss}	f=1MHz		70	110		
Turn-on time	td(on)	V _{CC} =300V R _G =10 Ω		25	40	ns	
	t _r	I _D =9A		70	110		
Turn-off time	td(off)	V _{GS} =10V		60	90		
	t _f			35	60		
Avalanche capability	I _{AV}	L=3.27mH T _{ch} =25°C	9			A	
Diode forward on-voltage	V _{SD}	I _F =2xI _{DR} V _{GS} =0V T _{ch} =25°C		1.0	1.5	V	
Reverse recovery time	t _{rr}	I _F =I _{DR} V _{GS} =0V		550		ns	
Reverse recovery charge	Q _{rr}	-di/dt=100A/μs T _{ch} =25°C		7.0		μC	

Thermal characteristics

Item	Symbol	Min.	Typ.	Max.	Units
Thermal resistance	R _{th(ch-c)}			2.08	°C/W
	R _{th(ch-a)}			75.0	°C/W

Characteristics

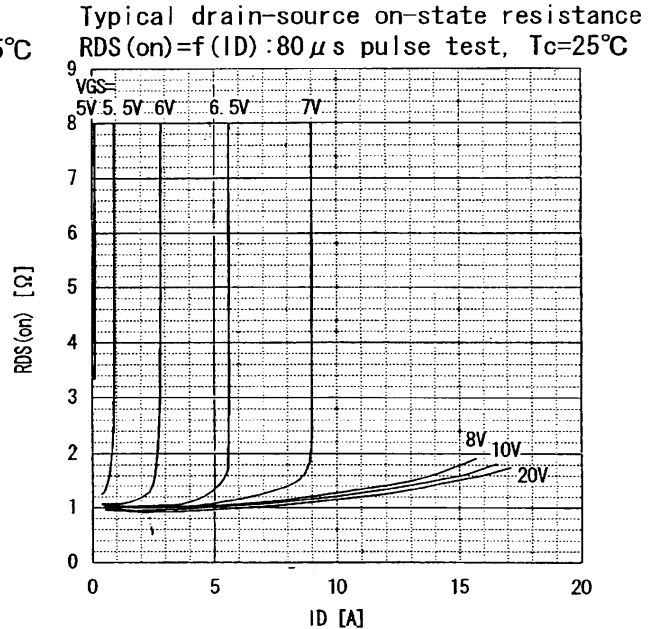
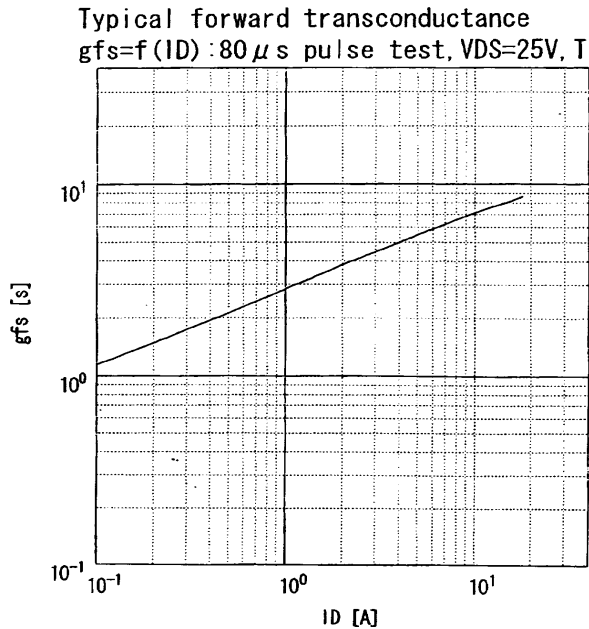
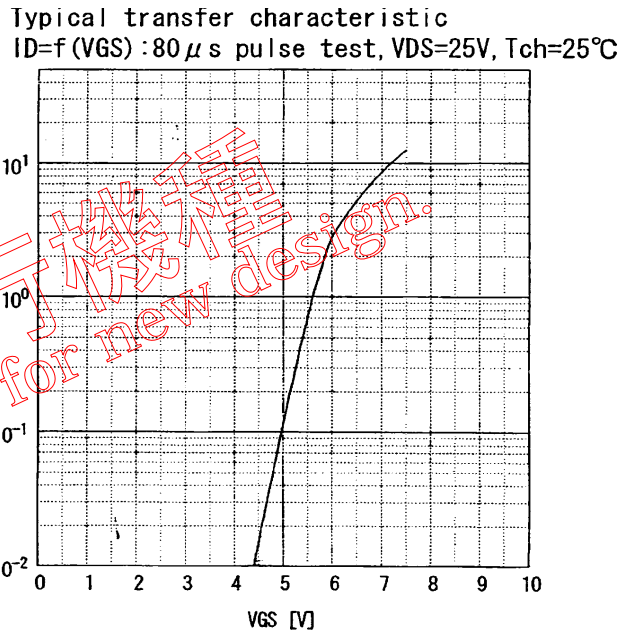
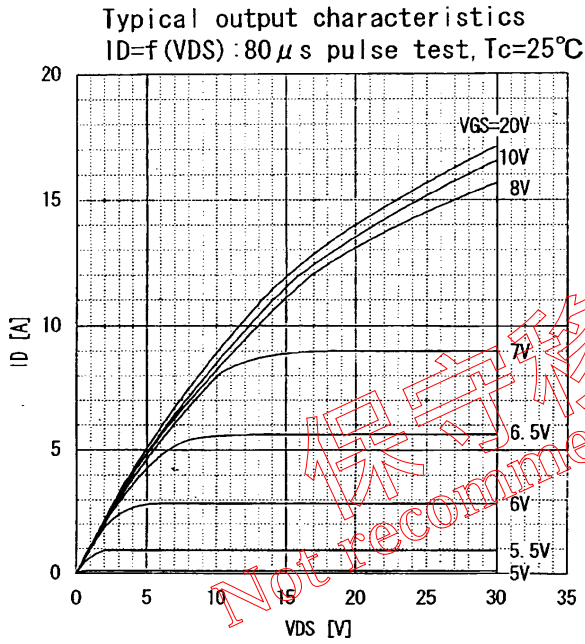
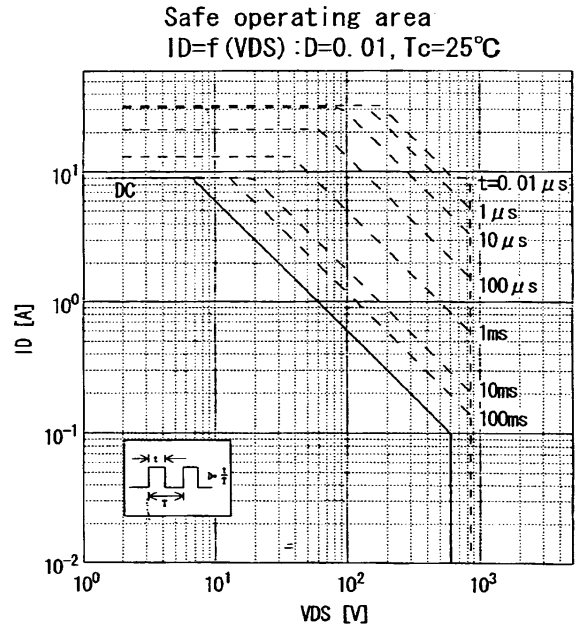
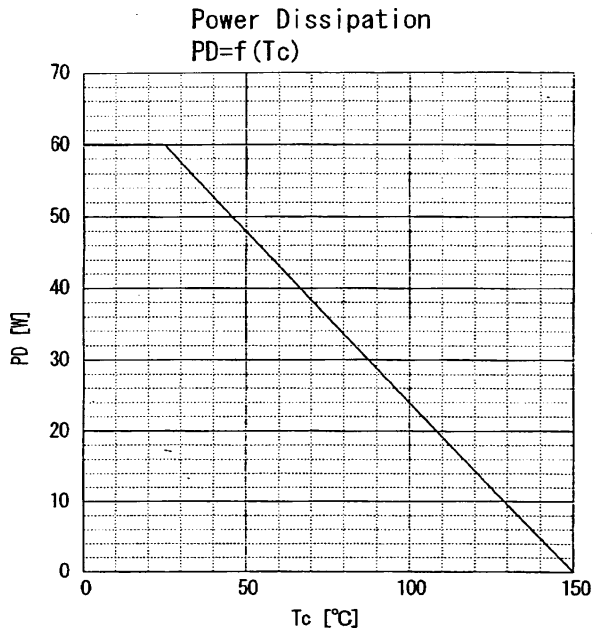

保守移行機種
 Not recommend for new design.

Drain-source on-state resistance
 $R_{DS(on)} = f(T_{ch}) : I_D = 4.5A, V_{GS} = 10V$

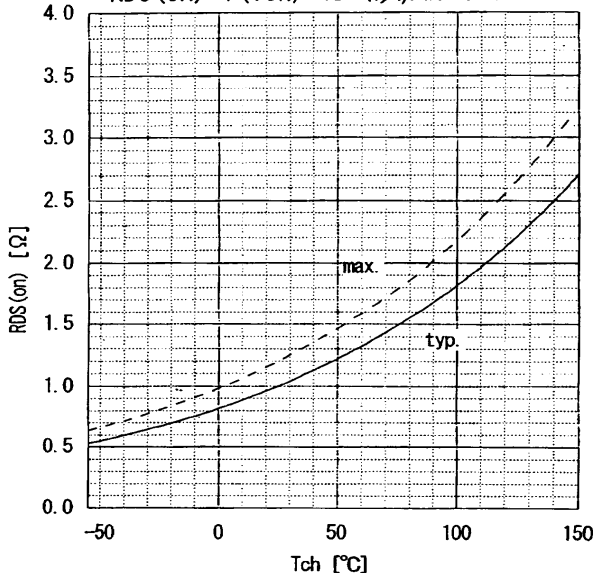

Gate threshold voltage
 $V_{GS(th)} = f(T_{ch}) : I_D = 1mA, V_{DS} = V_{GS}$

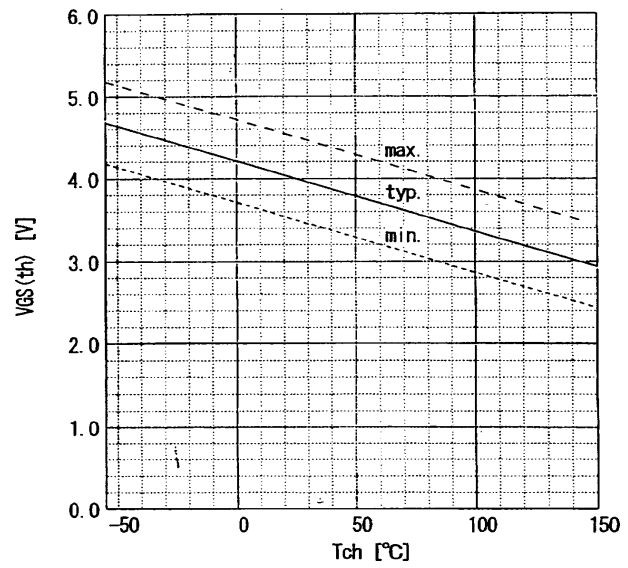

Typical gate charge characteristic
 $V_{GS} = f(Q_g) : I_D = 9A, T_c = 25°C$

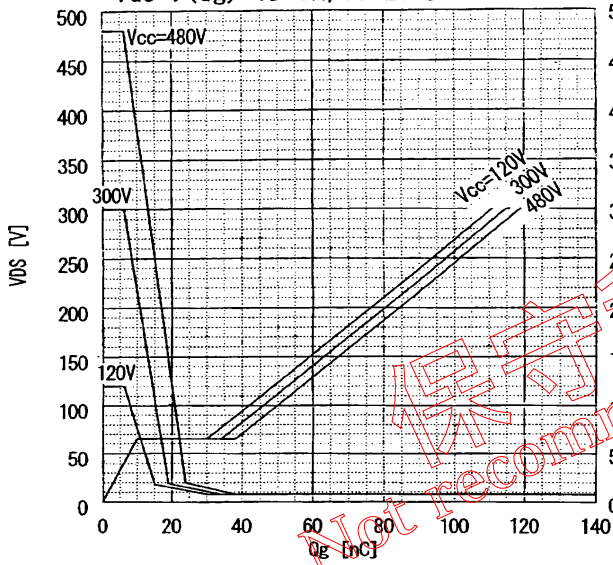

Typical capacitances
 $C = f(V_{DS}) : V_{GS} = 0V, f = 1MHz$

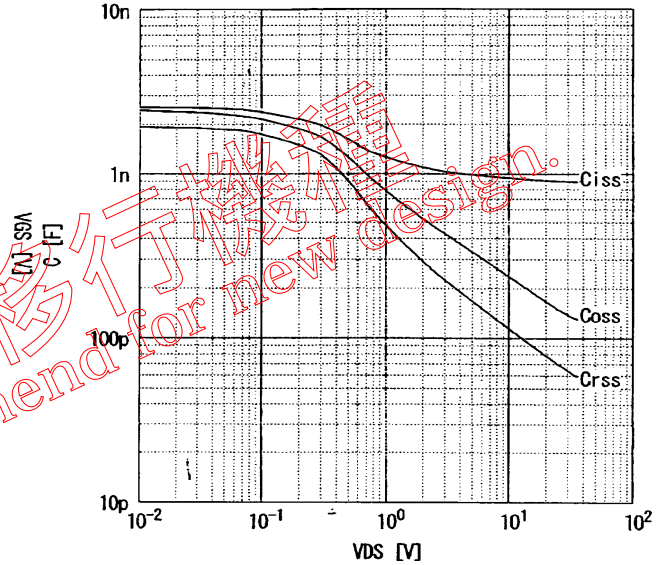

Forward characteristic of reverse of diode
 $I_F = f(V_{SD}) : 80\mu s \text{ pulses test}, V_{GS} = 0V$

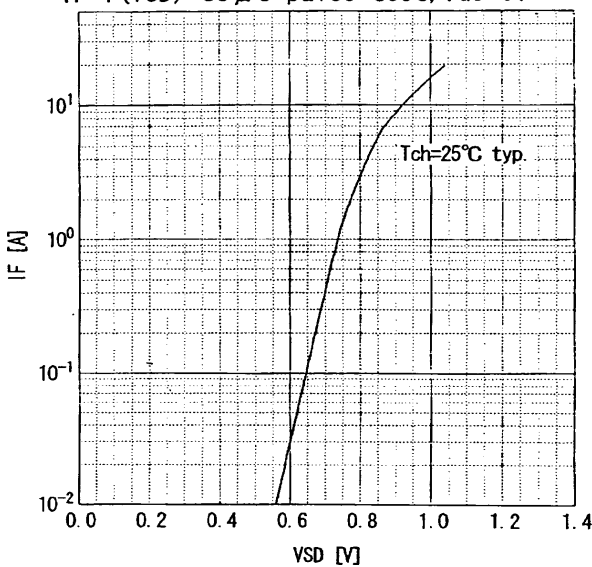

Avalanche energy derating
 $E_{as} = f(\text{starting } T_{ch}) : V_{CC} = 60V, I_{AV} = 9A$

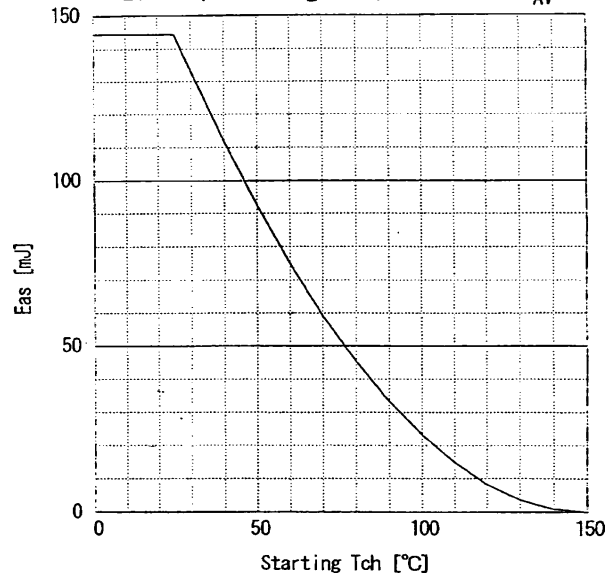

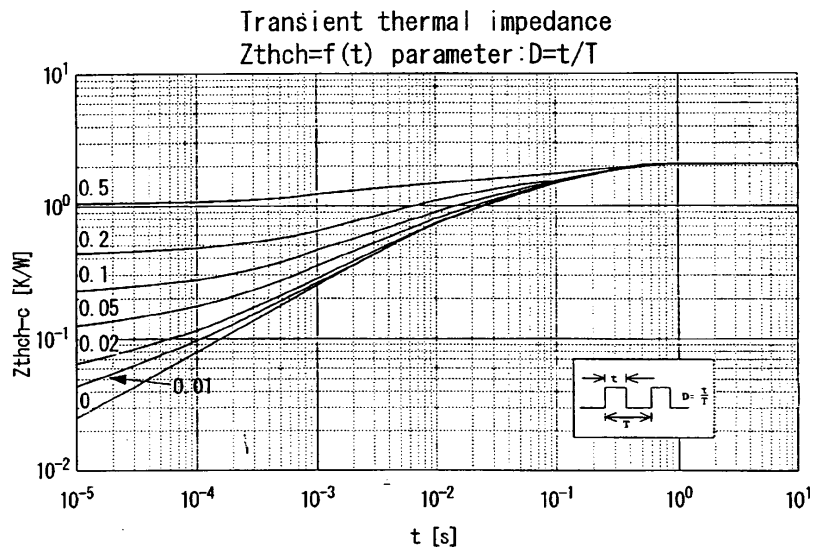

保守移行機種
Not recommend for new design.