

# 2SK3264-01MR

FUJI POWER MOS-FET

## N-CHANNEL SILICON POWER MOS-FET

### ■ Features

- High speed switching
- Low on-resistance
- No secondary breakdown
- Low driving power
- High voltage
- V<sub>GS</sub>=±30V Guarantee
- Avalanche-proof

### ■ Applications

- Switching regulators
- UPS
- DC-DC converters
- General purpose power amplifier

### ■ Maximum ratings and characteristic Absolute maximum ratings

● (T<sub>c</sub>=25°C unless otherwise specified)

Item	Symbol	Rating	Unit
Drain-source voltage	V <sub>DS</sub>	800	V
Continuous drain current	I <sub>D</sub>	±7	A
Pulsed drain current	I <sub>D(puls)</sub>	±28	A
Gate-source voltage	V <sub>GS</sub>	±35	V
Maximum Avalanche Energy	E <sub>AV*1</sub>	378.3	mJ
Max. power dissipation	P <sub>D</sub>	60	W
Operating and storage temperature range	T <sub>ch</sub> T <sub>stg</sub>	+150 -55 to +150	°C

\*1 L=14.2mH, V<sub>CC</sub>=80V

### ● Electrical characteristics (T<sub>c</sub> =25°C unless otherwise specified)

Item	Symbol	Test Conditions	Min.	Typ.	Max.	Units
Drain-source breakdown voltage	V <sub>(BR)DSS</sub>	I <sub>D</sub> =1mA V <sub>GS</sub> =0V	800			V
Gate threshold voltage	V <sub>GS(th)</sub>	I <sub>D</sub> =1mA V <sub>DS</sub> =V <sub>GS</sub>	3.5	4.0	4.5	V
Zero gate voltage drain current	I <sub>DSS</sub>	V <sub>DS</sub> =800V		10	500	μA
		V <sub>GS</sub> =0V		0.2	1.0	mA
Gate-source leakage current	I <sub>GSS</sub>	V <sub>GS</sub> =±35V V <sub>DS</sub> =0V		10	100	nA
Drain-source on-state resistance	R <sub>DS(on)</sub>	I <sub>D</sub> =3.5A V <sub>GS</sub> =10V		1.62	2.0	Ω
Forward transconductance	g <sub>fs</sub>	I <sub>D</sub> =3.5A V <sub>DS</sub> =25V	2.0	4.0		S
Input capacitance	C <sub>iss</sub>	V <sub>DS</sub> =25V		900	1350	pF
Output capacitance	C <sub>oss</sub>	V <sub>GS</sub> =0V		130	200	
Reverse transfer capacitance	C <sub>rss</sub>	f=1MHz		70	110	
Turn-on time t <sub>on</sub>	td(on)	V <sub>CC</sub> =600V I <sub>D</sub> =7A		25	40	ns
	t <sub>r</sub>	V <sub>GS</sub> =10V		90	140	
Turn-off time t <sub>off</sub>	td(off)	R <sub>GS</sub> =10 Ω		80	120	
	t <sub>f</sub>			50	80	
Avalanche capability	I <sub>AV</sub>	L=14.2mH T <sub>ch</sub> =25°C	7			A
Diode forward on-voltage	V <sub>SD</sub>	I <sub>F</sub> =2I <sub>D</sub> V <sub>GS</sub> =0V T <sub>ch</sub> =25°C		1.0	1.5	V
Reverse recovery time	t <sub>rr</sub>	I <sub>F</sub> =I <sub>D</sub> V <sub>GS</sub> =0V		900		ns
Reverse recovery charge	Q <sub>rr</sub>	-di/dt=100A/μs T <sub>ch</sub> =25°C		10		μC

### ● Thermal characteristics

Item	Symbol	Test Conditions	Min.	Typ.	Max.	Units
Thermal resistance	R <sub>th(ch-c)</sub>	channel to case			2.083	°C/W
	R <sub>th(ch-a)</sub>	channel to ambient			62.5	°C/W

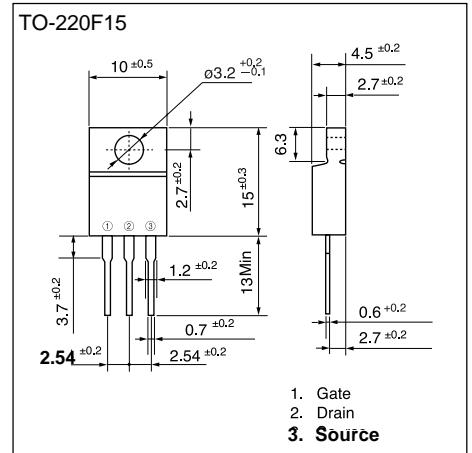

### ■ Equivalent circuit schematic

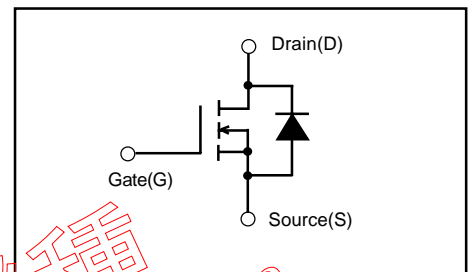

Characteristics

Typical output characteristics  
 $I_D=f(V_{DS})$ :80μs pulse test,  $T_c=25^\circ\text{C}$

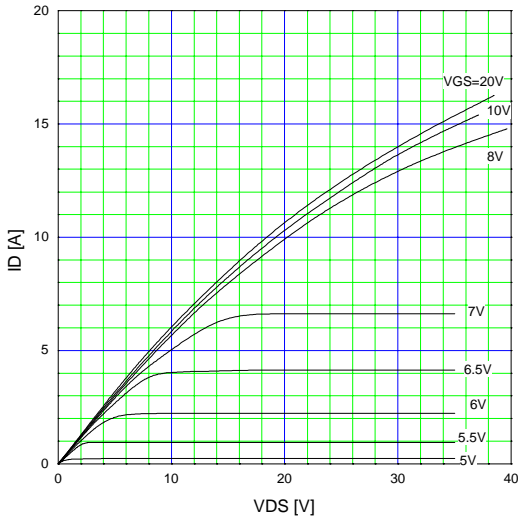

Drain-source on-state resistance  
 $R_{DS(on)}=f(T_{ch})$ : $I_D=3.5\text{A}$ ,  $V_{GS}=10\text{V}$

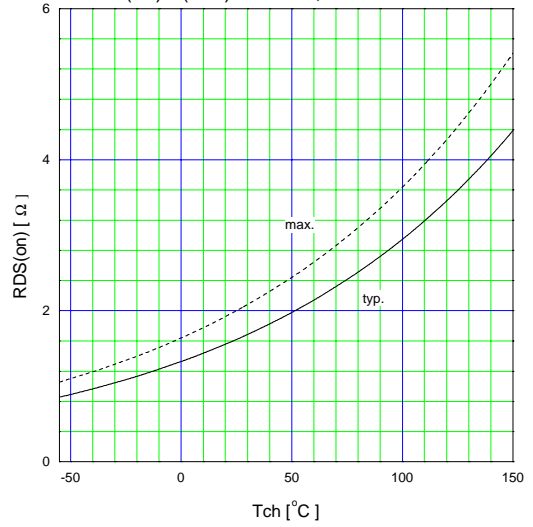

Typical transfer characteristic  
 $I_D=f(V_{GS})$ :80μs pulse test,  $V_{DS}=25\text{V}$ ,  $T_{ch}=25^\circ\text{C}$

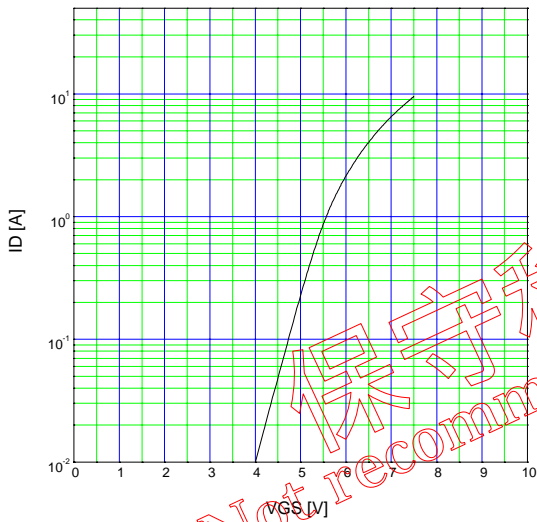

Typical Drain-Source on state resistance vs.  $I_D$   
 $R_{DS(on)}=f(I_D)$ :80μs pulse test,  $T_{ch}=25^\circ\text{C}$

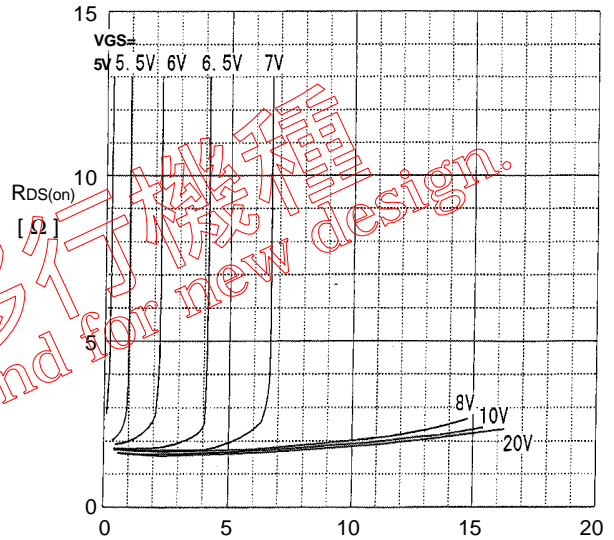

Typical forward transconductance  
 $g_{fs}=f(I_D)$ :80μs pulse test,  $V_{DS}=25\text{V}$ ,  $T_{ch}=25^\circ\text{C}$

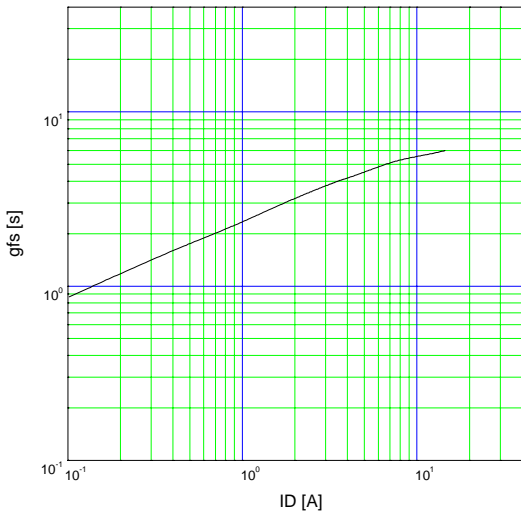

Gate threshold voltage  
 $V_{GS(th)}=f(T_{ch})$ : $I_D=1\text{mA}$ ,  $V_{DS}=V_{GS}$

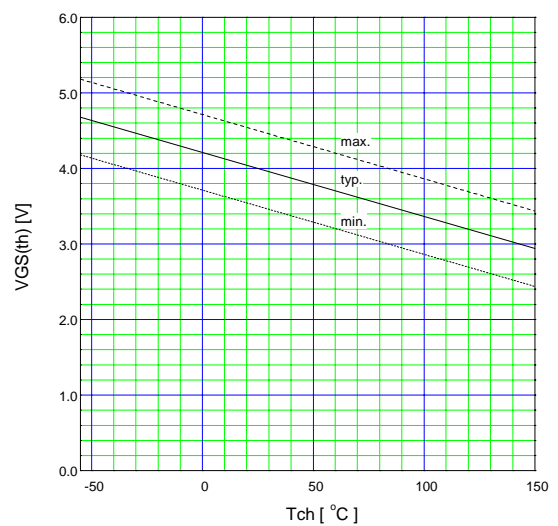

保守移行技術  
 Not recommend for new design.

Typical capacitances  
 $C=f(V_{DS}):V_{GS}=0V, f=1MHz$

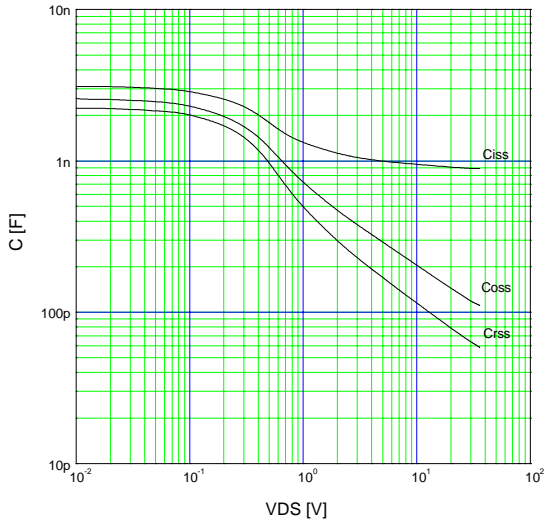

Typical gate charge characteristic  
 $V_{GS}=f(Q_g):I_D=7A, T_c=25^\circ C$

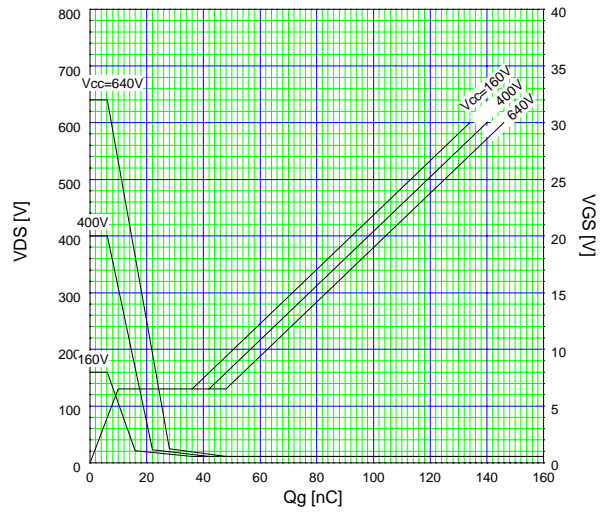

Forward characteristic of reverse of diode  
 $I_F=f(V_{SD}):80\mu s \text{ pules test}, V_{GS}=0V$

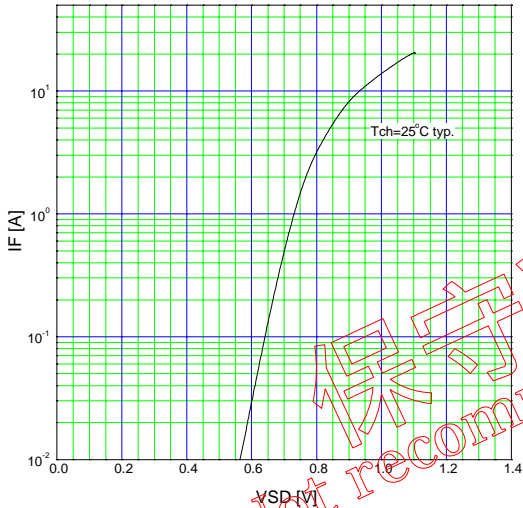

Power Dissipation  
 $PD=f(T_c)$

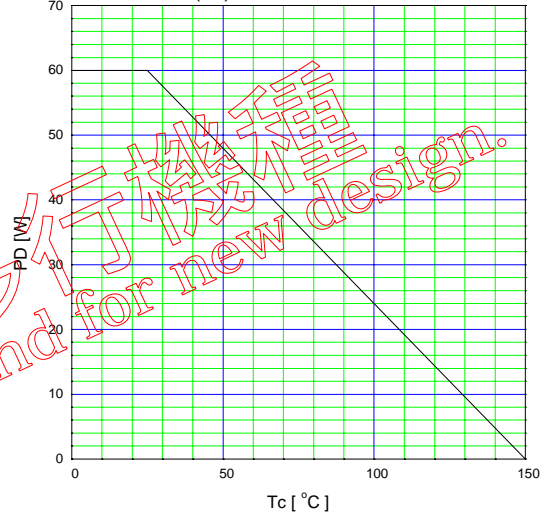

Transient Thermal Impedance  
 $Z_{th}(ch-c)=f(t):D=t/T$

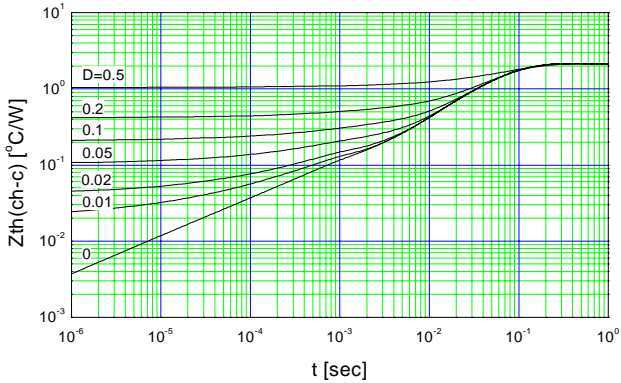

Safe operating area  
 $I_D=f(V_{DS}):D=0.01, T_c=25^\circ C$

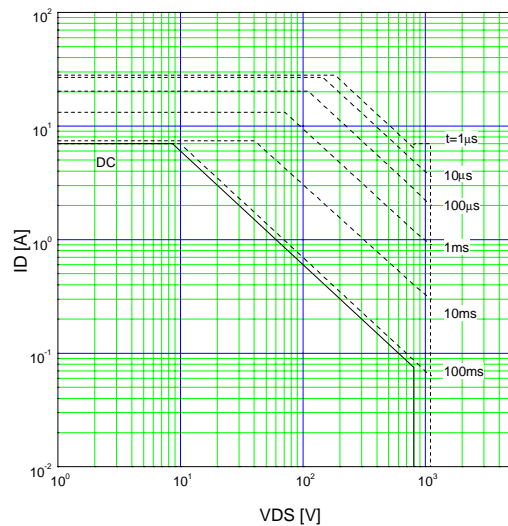

保守移行技術  
 Not recommend for new design.

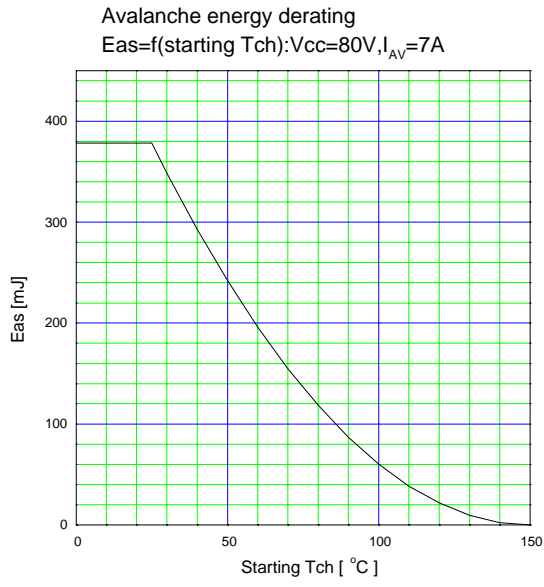

保守移行機種  
Not recommend for new design.