

## N-CHANNEL SILICON POWER MOSFET Trench Power MOSFET

### Features

- High speed switching
- Low on-resistance
- No secondary breakdown
- Low driving power
- Avalanche-proof

### Applications

- Switching regulators
- DC-DC converters
- General purpose power amplifier

### Maximum ratings and characteristics

#### Absolute maximum ratings (Tc=25°C unless otherwise specified)

Item	Symbol	Rating	Unit	Remarks
Drain-source voltage	V <sub>DS</sub>	60	V	
	V <sub>DSX</sub>	30	V	V <sub>GS</sub> =-20V
Continuous drain current	I <sub>D</sub>	±100	A	
Pulsed drain current	I <sub>D</sub> [puls]	±400	A	
Gate-source peak voltage	V <sub>GS</sub>	+30/-20	V	
Maximum avalanche energy	E <sub>AV</sub>	387.4	mJ	*1
Maximum power dissipation	P <sub>D</sub>	155	W	
Operating and storage temperature range	T <sub>ch</sub>	+150	°C	
	T <sub>stg</sub>	-55 to +150	°C	

\*1 L=51.7μH, V<sub>CC</sub>=24V

#### Electrical characteristics (Tc =25°C unless otherwise specified)

Item	Symbol	Test Conditions	Min.	Typ.	Max.	Units
Drain-source breakdown voltage	BV <sub>DSS</sub>	I <sub>D</sub> =1mA V <sub>GS</sub> =0V	60			V
	BV <sub>DSX</sub>	I <sub>D</sub> =1mA V <sub>GS</sub> =-20V	30			V
Gate threshold voltage	V <sub>GS(th)</sub>	I <sub>D</sub> =10mA V <sub>DS</sub> =V <sub>GS</sub>	2.5	3.0	3.5	V
Zero gate voltage drain current	I <sub>DSS</sub>	V <sub>DS</sub> =60V V <sub>GS</sub> =0V	T <sub>ch</sub> =25°C	1.0	100	μA
			T <sub>ch</sub> =125°C	10	500	μA
Gate-source leakage current	I <sub>GSS</sub>	V <sub>GS</sub> =+30V,-20V V <sub>DS</sub> =0V		10	100	nA
Drain-source on-state resistance	R <sub>DSON</sub>	I <sub>D</sub> =50A V <sub>GS</sub> =10V		5.0	6.5	mΩ
Forward transconductance	g <sub>fs</sub>	I <sub>D</sub> =50A V <sub>DS</sub> =10V	25	50		S
Input capacitance	C <sub>iss</sub>	V <sub>DS</sub> =25V		9000		pF
Output capacitance	C <sub>oss</sub>	V <sub>GS</sub> =0V		1250		
Reverse transfer capacitance	C <sub>rss</sub>	f=1MHz		700		
Turn-on time	t <sub>d(on)</sub>	V <sub>CC</sub> =30V R <sub>G</sub> =10 Ω		50		
	t <sub>r</sub>	I <sub>D</sub> =100A		200		
Turn-off time	t <sub>d(off)</sub>	V <sub>GS</sub> =10V		150		ns
	t <sub>f</sub>			135		
Total gate charge	Q <sub>g</sub>	V <sub>CC</sub> =30V		145		nC
Gate-Source charge	Q <sub>gs</sub>	I <sub>D</sub> =100A		60		
Gate-Drain charge	Q <sub>gd</sub>	V <sub>GS</sub> =10V		40		
Avalanche capability	I <sub>AV</sub>	L=100μH T <sub>ch</sub> =25°C	100			A
Diode forward on-voltage	V <sub>SD</sub>	I <sub>F</sub> =100A V <sub>GS</sub> =0V T <sub>ch</sub> =25°C		1.0	1.5	V
Reverse recovery time	t <sub>rr</sub>	I <sub>F</sub> =50A V <sub>GS</sub> =0V		85		ns
Reverse recovery charge	Q <sub>rr</sub>	-di/dt=100A/μs T <sub>ch</sub> =25°C		0.25		μC

#### Thermal characteristics

Item	Symbol	Min.	Typ.	Max.	Units
Thermal resistance	R <sub>th(ch-c)</sub>			0.806	°C/W
	R <sub>th(ch-a)</sub>			50.0	°C/W

### Outline Drawings

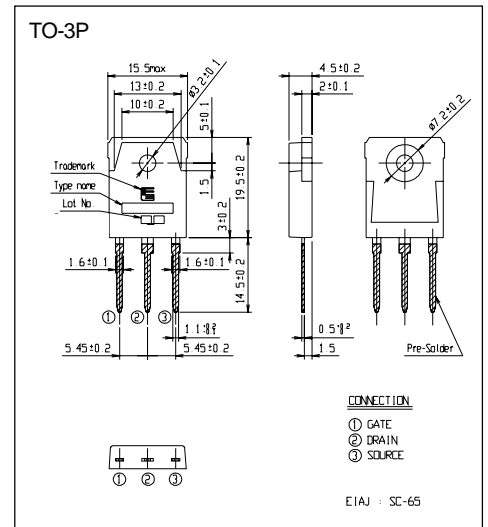

### Equivalent circuit schematic

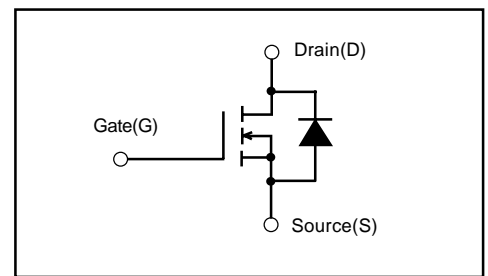

Characteristics

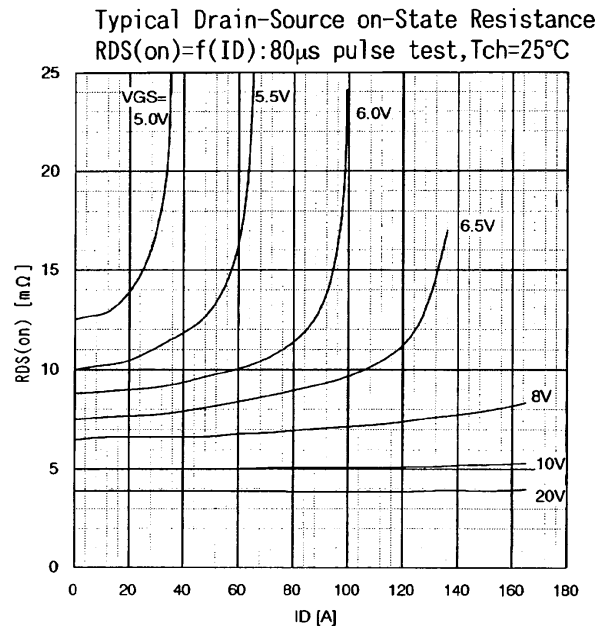
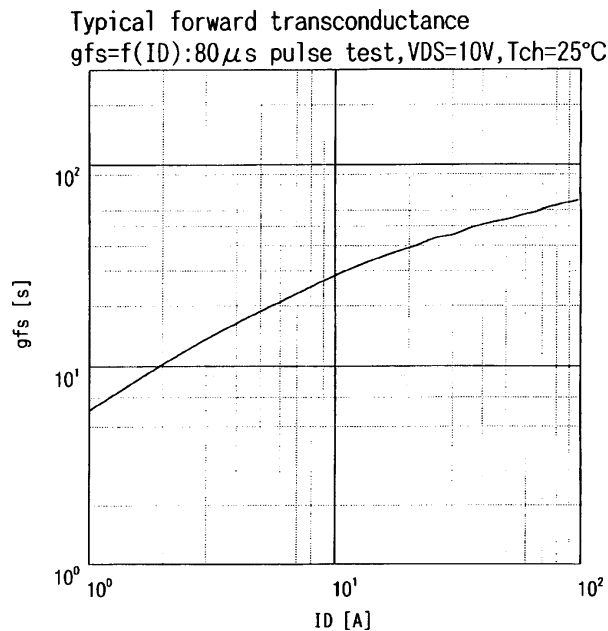
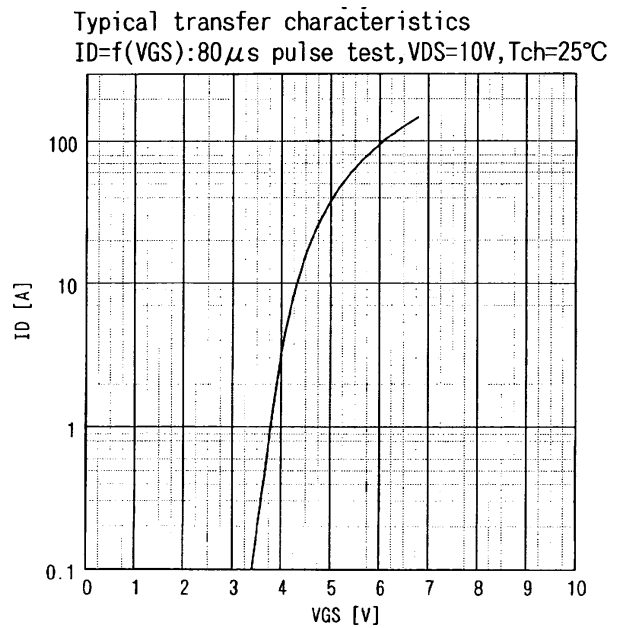
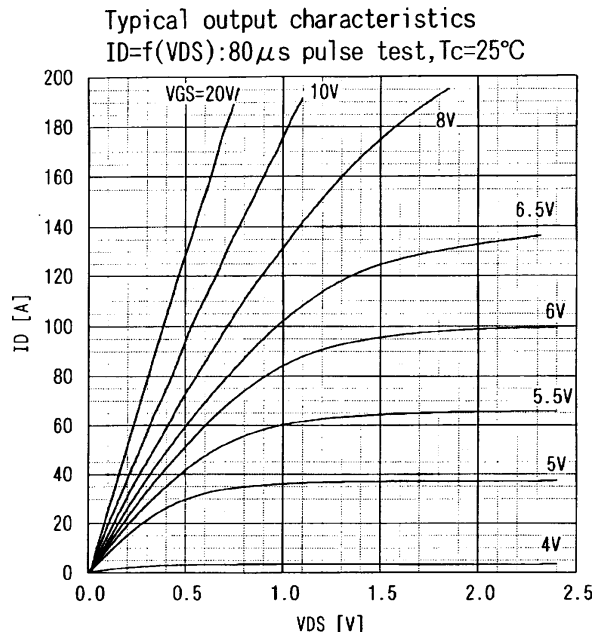
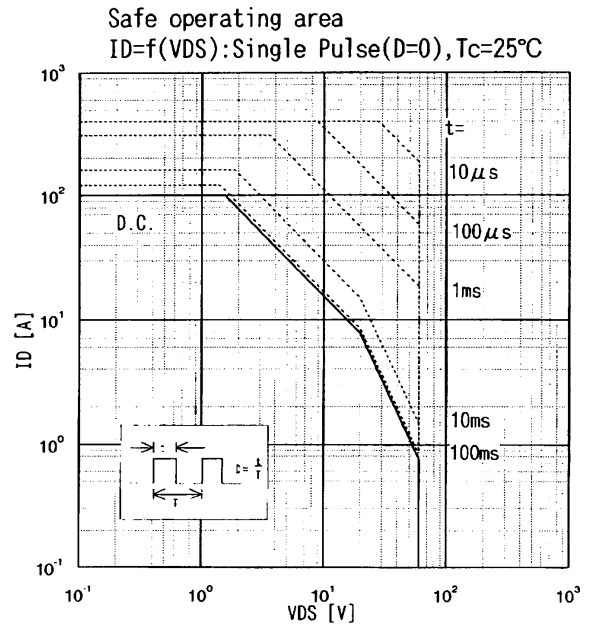
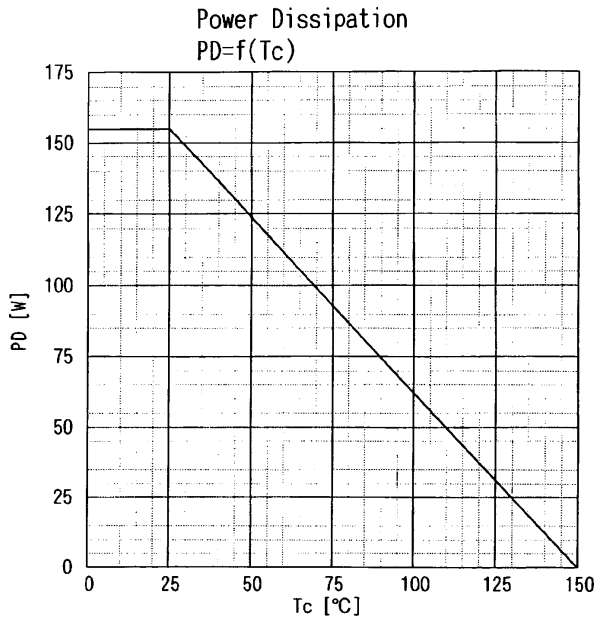

Drain-source on-state resistance  
 $R_{DS(on)} = f(T_{ch}) : I_D = 50A, V_{GS} = 10V$

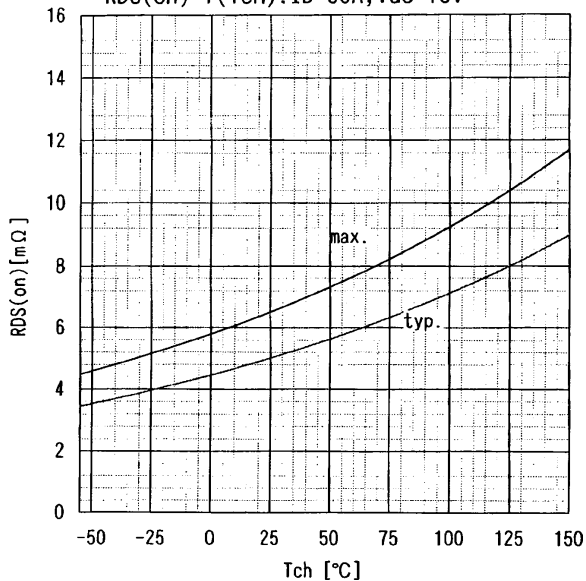

Gate Threshold Voltage vs. Tch  
 $V_{GS(th)} = f(T_{ch}) : V_{DS} = V_{GS}, I_D = 10mA$

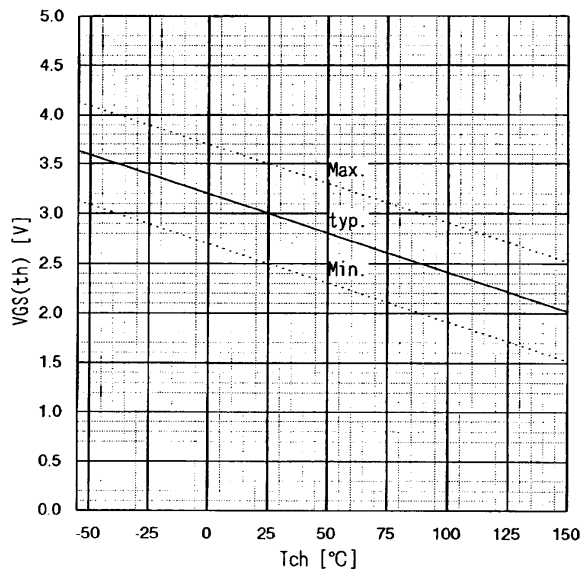

Typical capacitances  
 $C = f(V_{DS}) : V_{GS} = 0V, f = 1MHz$

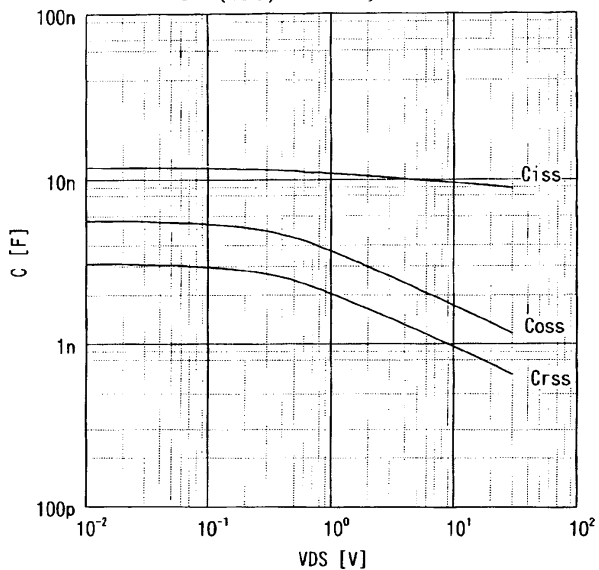

Maximum Avalanche Current vs. starting Tch  
 $I_{(AV)} = f(\text{starting } Tch), \text{ single pulse}$

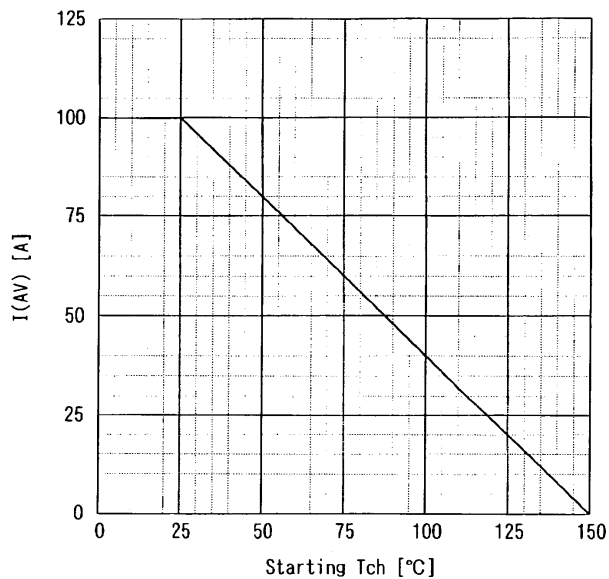

Maximum Avalanche energy vs. starting Tch  
 $E_{as} = f(\text{starting } Tch) : V_{CC} = 24V, I_{AV} \le 100A, \text{ single pulse}$

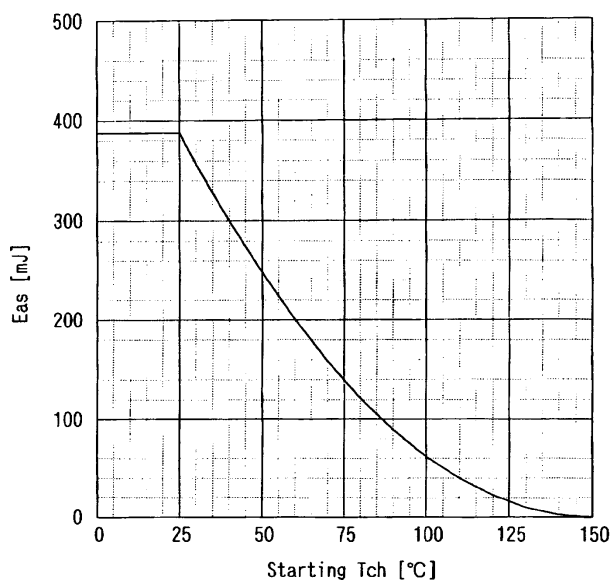

Typical Gate Charge Characteristics  
 $V_{GS} = f(Q_g) : I_D = 100A, Tch = 25°C$

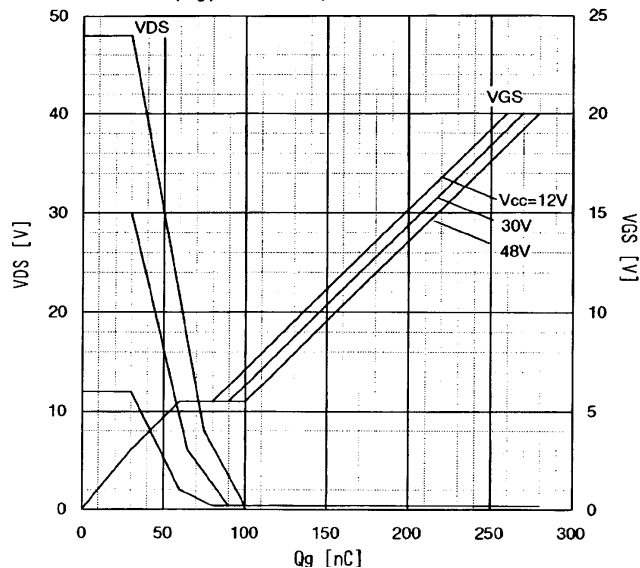

Typical Forward Characteristics of Reverse Diode  
 $-I_D=f(V_{SD}): 80\mu s$  pulse test,  $T_{ch}=25^\circ C$

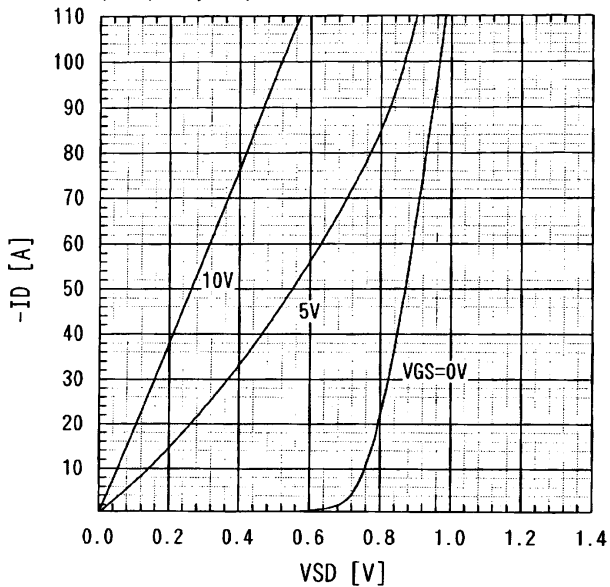

Typical Switching Characteristics vs.  $I_D$   
 $t=f(I_D): V_{cc}=30V, V_{GS}=10V, R_G=10\Omega$

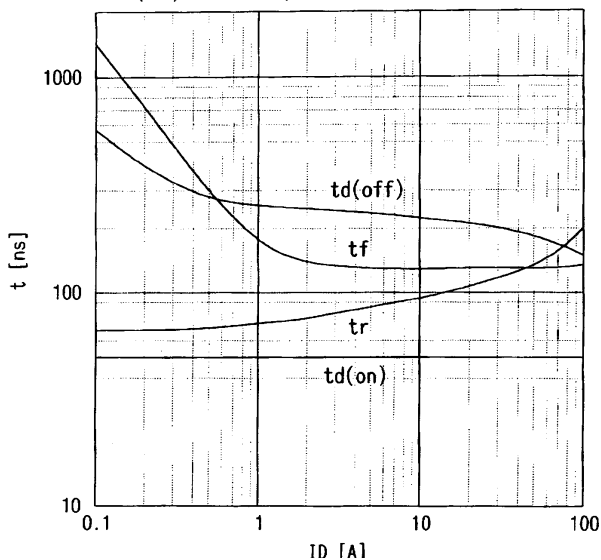

Drain-Source Breakdown Voltage vs.  $V_{GS}$   
 $BV_{DSX}=f(V_{GS}): T_{ch}=25^\circ C$

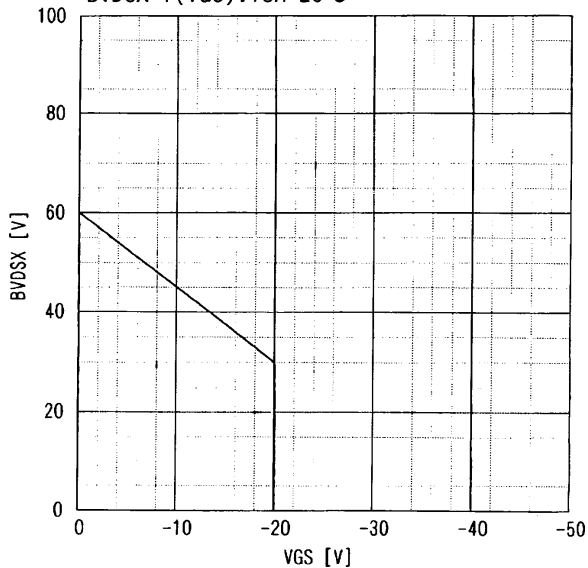

Transient Thermal Impedance  
 $Z_{th(ch-c)}=f(t): D=t/T$

