

N-CHANNEL SILICON POWER MOS-FET

Features

- High speed switching
- Low on-resistance
- No secondary breakdown
- Low driving power
- Avalanche-proof

Applications

- Switching regulators
- UPS (Uninterruptible Power Supply)
- DC-DC converters

Maximum ratings and characteristic Absolute maximum ratings

(T_c=25°C unless otherwise specified)

Item	Symbol	Rating	Unit
Drain-source voltage	V _{DS}	500	V
Continuous drain current	I _D	±27	A
Pulsed drain current	I _{D(puls)}	±108	A
Gate-source voltage	V _{GS}	±30	V
Repetitive or non-repetitive	IAR *2	27	A
Maximum Avalanche Energy	EAV *1	914	mJ
Max. power dissipation	P _D	400	W
Operating and storage temperature range	T _{ch} T _{stg}	+150 -55 to +150	°C

*1 L=2.30mH, V_{cc}=50V *2 T_{ch}≤150°C

Electrical characteristics (T_c =25°C unless otherwise specified)

Item	Symbol	Test Conditions	Min.	Typ.	Max.	Units
Drain-source breakdown voltage	V _{(BR)DSS}	I _D =1mA V _{GS} =0V	500			V
Gate threshold voltage	V _{GS(th)}	I _D =1mA V _{DS} =V _{GS}	2.5	3.0	3.5	V
Zero gate voltage drain current	I _{DSS}	V _{DS} =500V V _{GS} =0V	T _{ch} =25°C	10	500	μA
			T _{ch} =125°C	0.2	1.0	mA
Gate-source leakage current	I _{gss}	V _{GS} =±30V V _{DS} =0V		10	100	nA
Drain-source on-state resistance	R _{DS(on)}	I _D =13.5A V _{GS} =10V		0.16	0.2	Ω
Forward transconductance	g _{fs}	I _D =13.5A V _{DS} =25V	11	22		S
Input capacitance	C _{iss}	V _{DS} =25V		4300	6450	pF
Output capacitance	C _{oss}	V _{GS} =0V		630	945	pF
Reverse transfer capacitance	C _{rss}	f=1MHz		285	430	pF
Turn-on time t _{on}	t _{d(on)} t _r	V _{CC} =300V I _D =27A V _{GS} =10V		40	60	ns
				145	220	
Turn-off time t _{off}	t _{d(off)} t _f	R _{GS} =10Ω		315	475	ns
				150	225	
Total gate charge	Q _G	V _{CC} =250V		198	300	nC
Gate-Source charge	Q _{GS}	I _D =27A		38	60	
Gate-Drain charge	Q _{GD}	V _{GS} =10V		81	125	
Avalanche capability	I _{AV}	L=2.30mH T _{ch} =25°C	27			A
Diode forward on-voltage	V _{SD}	I _F =2xI _{DR} V _{GS} =0V T _{ch} =25°C		1.2	1.8	V
Reverse recovery time	t _{rr}	I _F =I _{DR} V _{GS} =0V		660		ns
Reverse recovery charge	Q _{rr}	-di/dt=100A/μs T _{ch} =25°C		15.0		μC

Thermal characteristics

Item	Symbol	Test Conditions	Min.	Typ.	Max.	Units
Thermal resistance	R _{th(ch-c)}	channel to case			0.3125	°C/W
	R _{th(ch-a)}	channel to ambient			50.0	°C/W

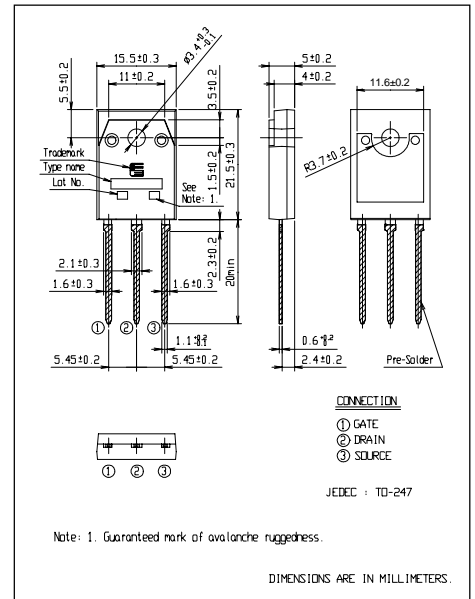

Equivalent circuit schematic

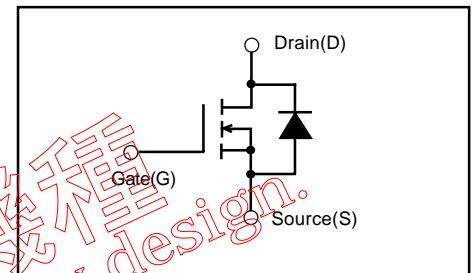

Characteristics

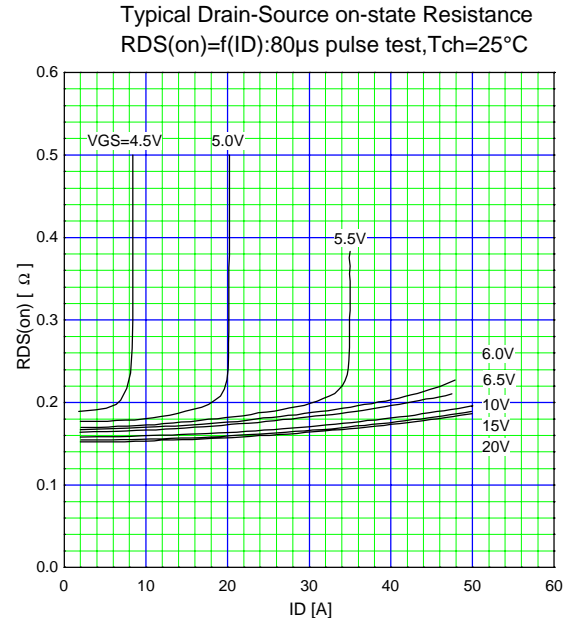
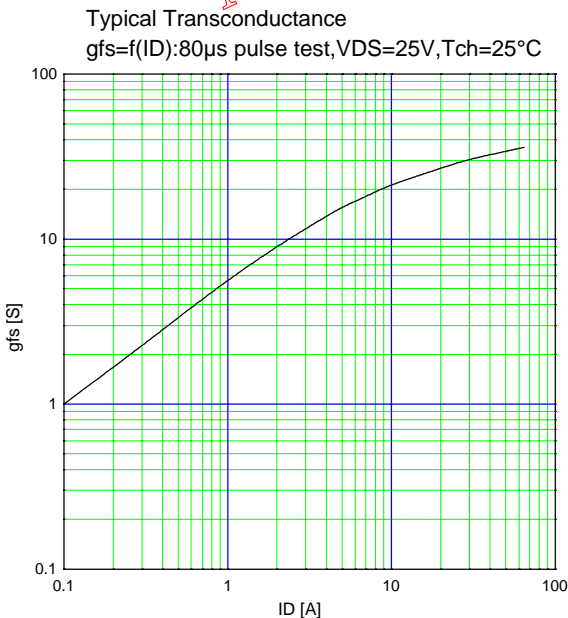
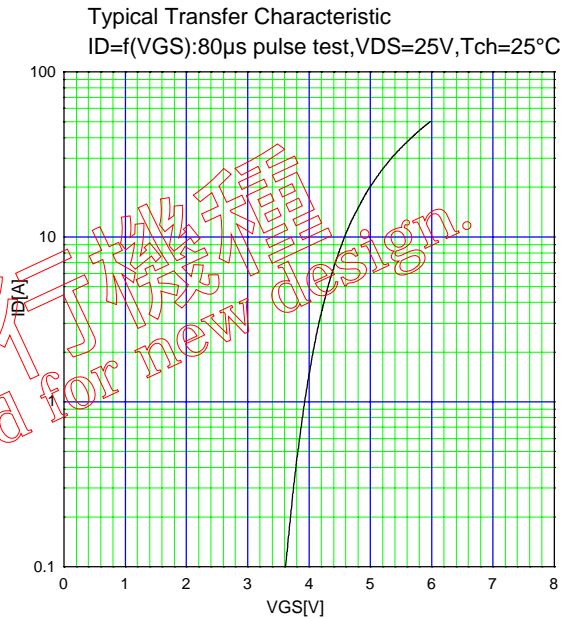
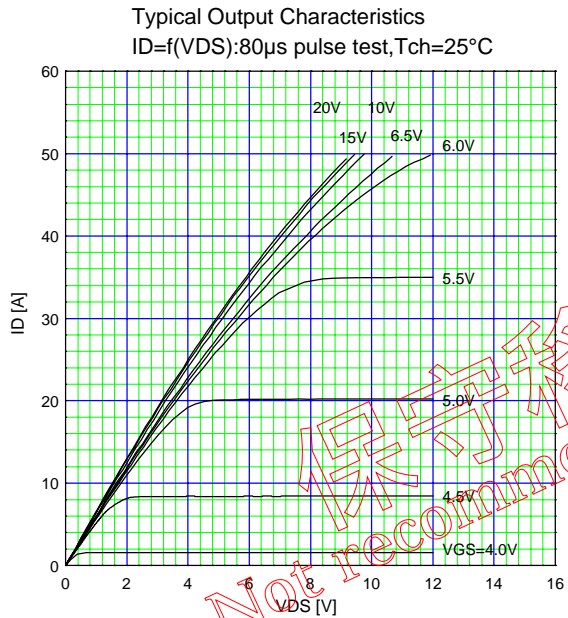
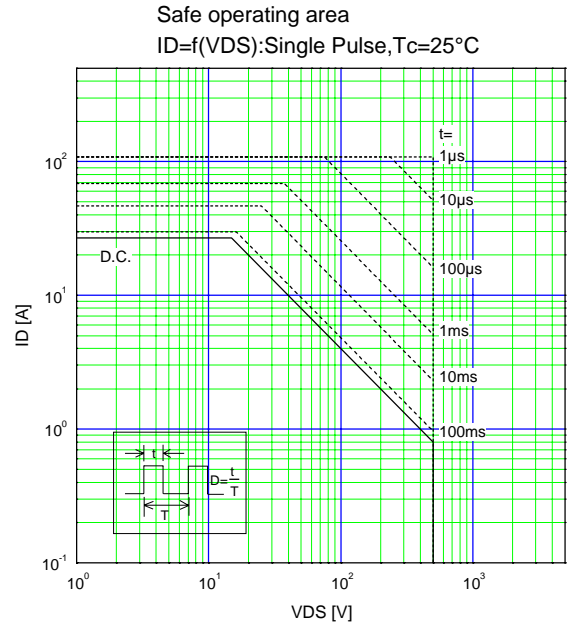
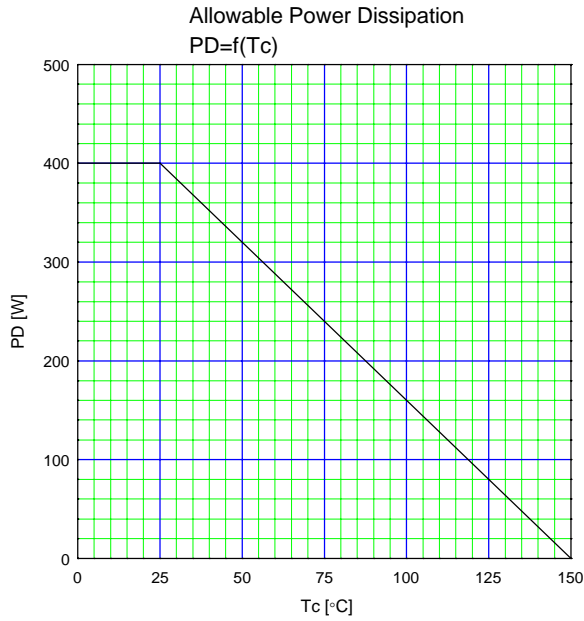

保留行機碼
 Not recommend for new design.

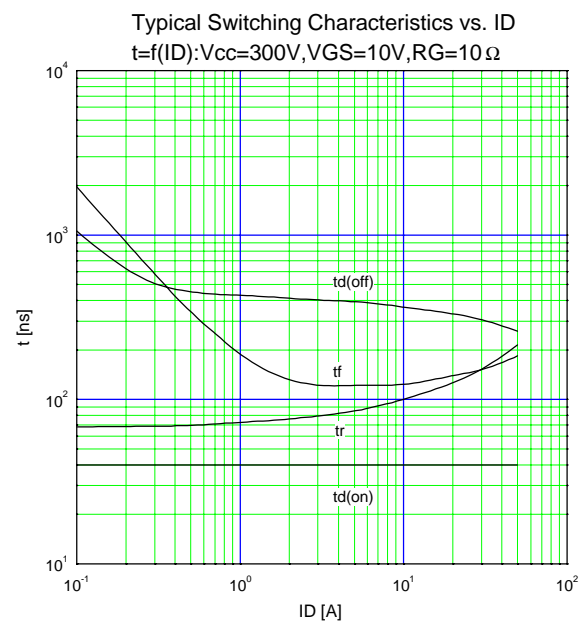
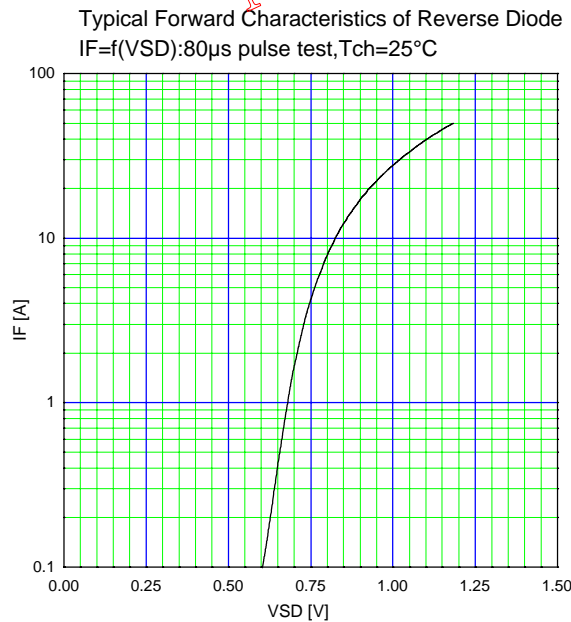
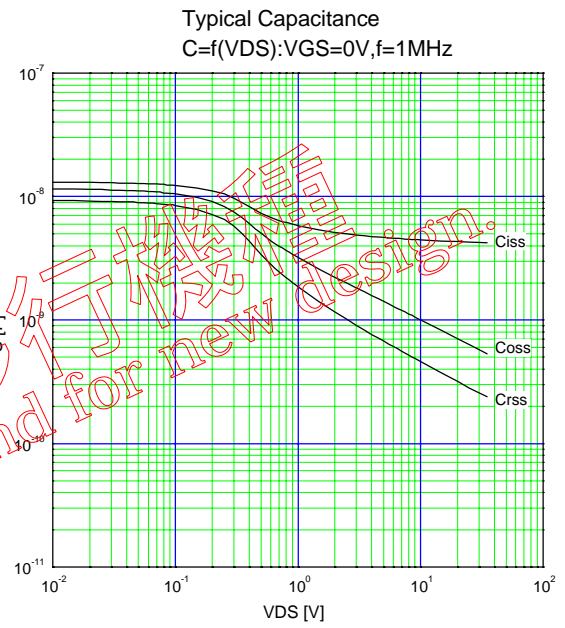
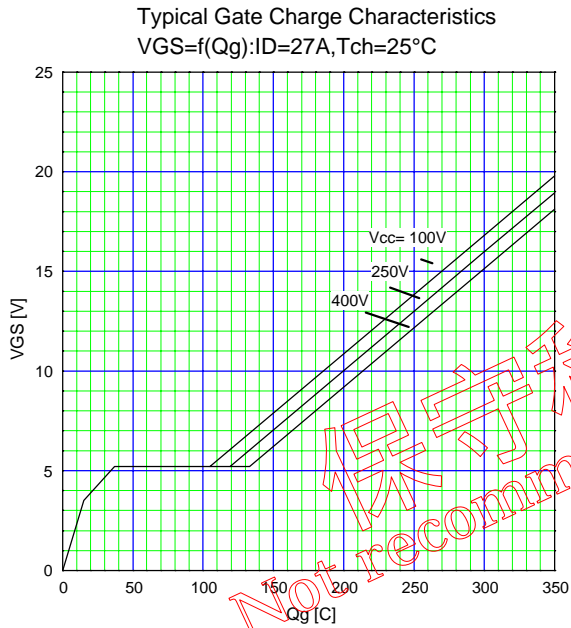
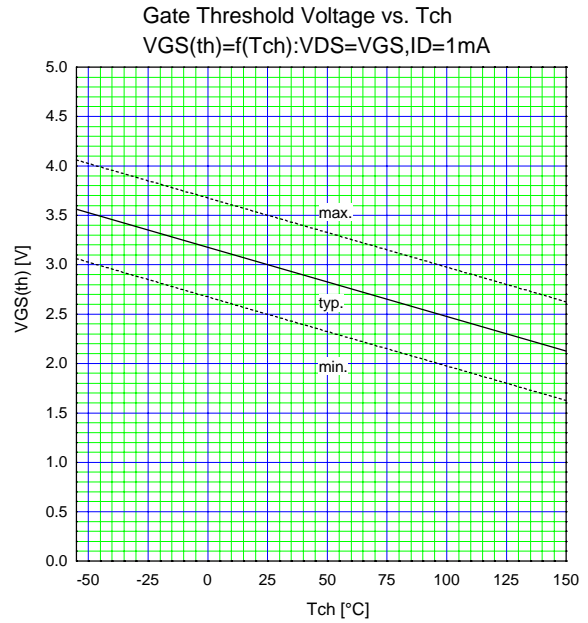
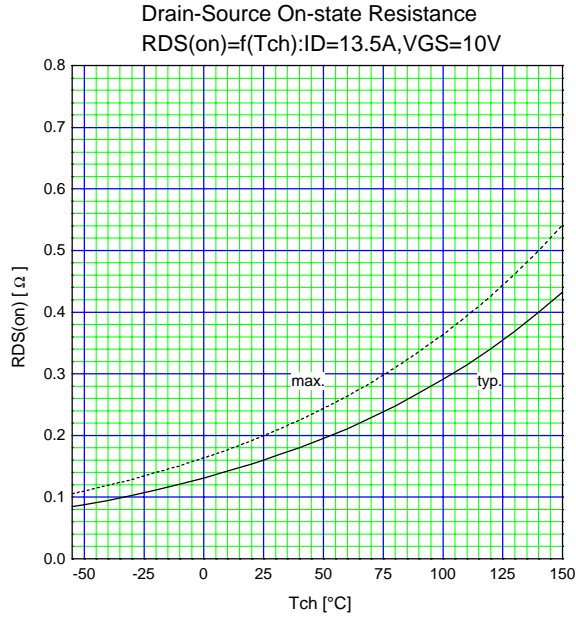

保持移行機組
 Not recommend for new design.

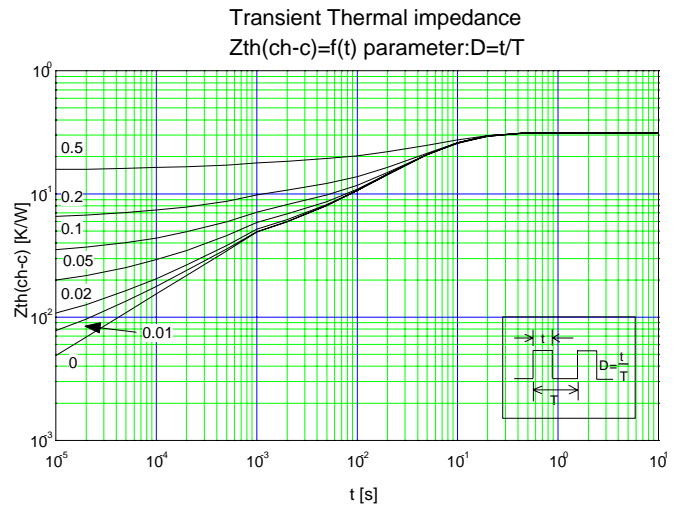
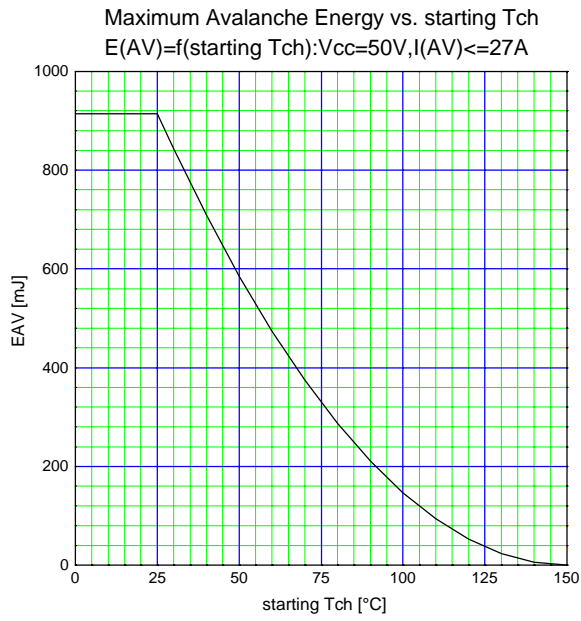

保守移行機種
 Not recommend for new design.