

FUJI POWER MOSFET Super FAP-G Series

N-CHANNEL SILICON POWER MOSFET

Features

- High speed switching
- Low on-resistance
- No secondary breakdown
- Low driving power
- Avalanche-proof

Applications

- Switching regulators
- UPS (Uninterruptible Power Supply)
- DC-DC converters

Maximum ratings and characteristic Absolute maximum ratings

● (T_c=25°C unless otherwise specified)

Item	Symbol	Ratings	Unit
Drain-source voltage	V _{DS}	150	V
	V _{DSX} *5	120	V
Continuous drain current	I _D	±57	A
Pulsed drain current	I _{D(puls)}	±228	A
Gate-source voltage	V _{GS}	±30	V
Non-repetitive Avalanche current	I _{AS} *2	57	A
Maximum Avalanche Energy	E _{AS} *1	272.5	mJ
Maximum Drain-Source dV/dt	dV _{DS} /dt *4	20	kV/μs
Peak Diode Recovery dV/dt	dV/dt *3	5	kV/μs
Max. power dissipation	P _D	T _a =25°C	2.02
		T _c =25°C	270
Operating and storage temperature range	T _{ch}	+150	°C
	T _{stg}	-55 to +150	°C

*1 L=123μH, V_{CC}=48V, See to Avalanche Energy Graph *2 T_{ch} ≤150°C

*3 I_F ≤ -I_D, -di/dt=50A/μs, V_{CC} ≤ BV_{DSS}, T_{ch} ≤ 150°C *4 V_{DS} ≤ 150V *5 V_{GS} = -30V

Electrical characteristics (T_c =25°C unless otherwise specified)

Item	Symbol	Test Conditions	Min.	Typ.	Max.	Units
Drain-source breakdown voltage	V _{(BR)DSS}	I _D = 250μA V _{GS} =0V	150			V
Gate threshold voltage	V _{GS(th)}	I _D = 250μA V _{DS} =V _{GS}	3.0		5.0	V
Zero gate voltage drain current	I _{DSS}	V _{DS} =150V V _{GS} =0V			25	μA
		V _{DS} =120V V _{GS} =0V			250	
Gate-source leakage current	I _{GSS}	V _{GS} =±30V V _{DS} =0V		10	100	nA
Drain-source on-state resistance	R _{DS(on)}	I _D =20A V _{GS} =10V		31	41	mΩ
Forward transconductance	g _{fs}	I _D =20A V _{DS} =25V	13	26		S
Input capacitance	C _{iss}	V _{DS} =75V		1940	2910	pF
Output capacitance	C _{oss}	V _{GS} =0V		310	465	
Reverse transfer capacitance	C _{rss}	f=1MHz		24	36	
Turn-on time t _{on}	td(on)	V _{CC} =48V I _D =20A		20	30	ns
	t _r	V _{GS} =10V		26	39	
Turn-off time t _{off}	td(off)	R _{GS} =10 Ω		50	75	ns
	t _f			20	30	
Total Gate Charge	Q _G	V _{CC} =75V		52	78	nC
Gate-Source Charge	Q _{GS}	I _D =40A		15	22.5	
Gate-Drain Charge	Q _{GD}	V _{GS} =10V		18	27	
Avalanche capability	I _{AV}	L=123μH T _{ch} =25°C	57			A
Diode forward on-voltage	V _{SD}	I _F =40A V _{GS} =0V T _{ch} =25°C		1.10	1.65	V
Reverse recovery time	t _{rr}	I _F =40A V _{GS} =0V		0.14		μs
Reverse recovery charge	Q _{rr}	-di/dt=100A/μs T _{ch} =25°C		0.77		μC

Thermal characteristics

Item	Symbol	Test Conditions	Min.	Typ.	Max.	Units
Thermal resistance	R _{th(ch-c)}	channel to case			0.463	°C/W
	R _{th(ch-a)}	channel to ambient			62.0	°C/W

Outline Drawings (mm)

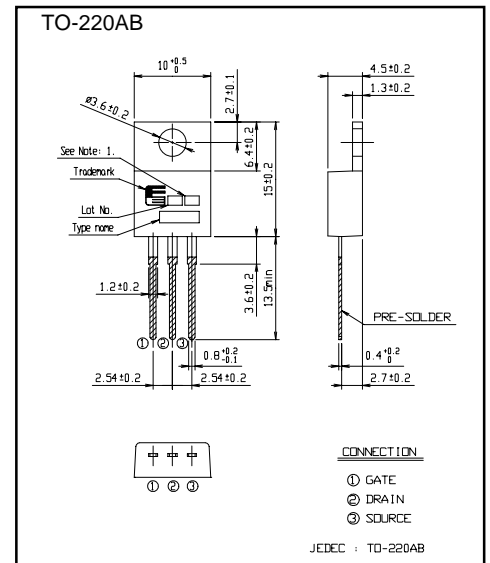

Equivalent circuit schematic

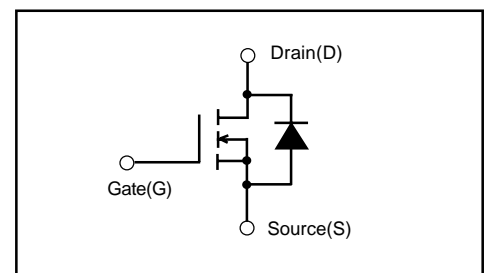

Characteristics

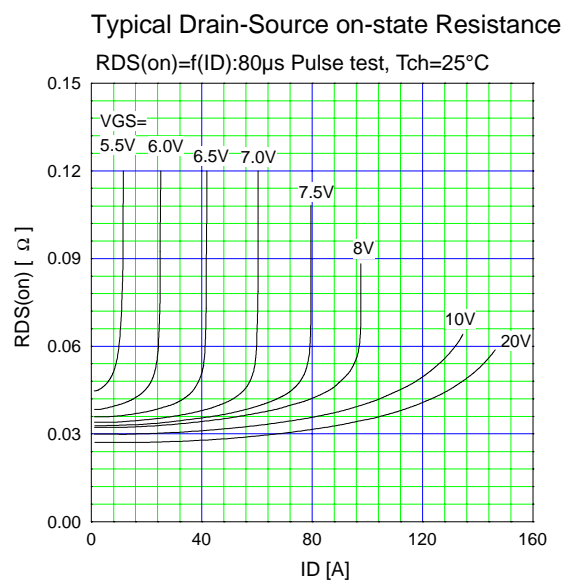
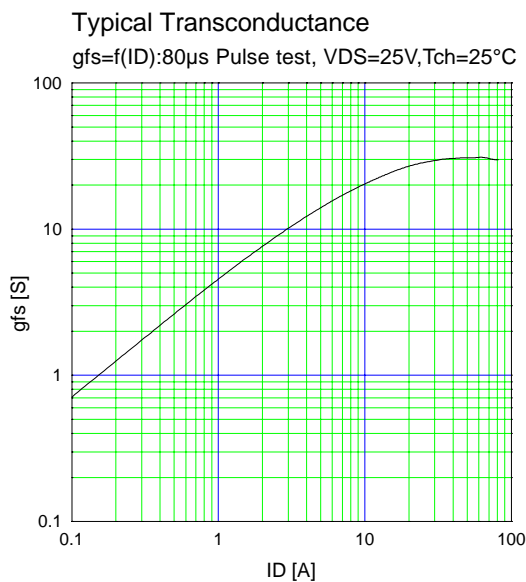
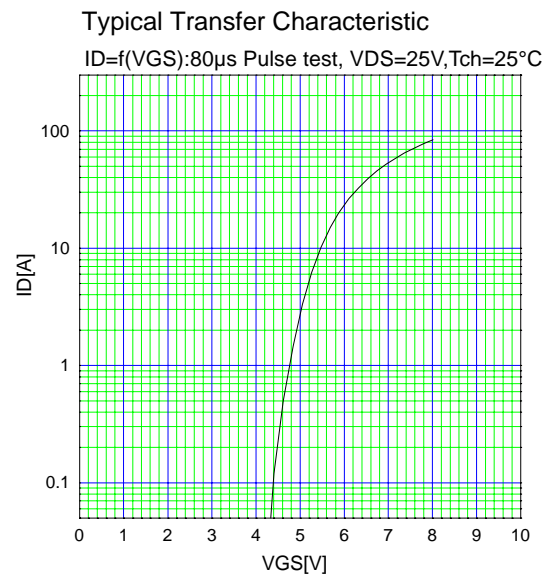
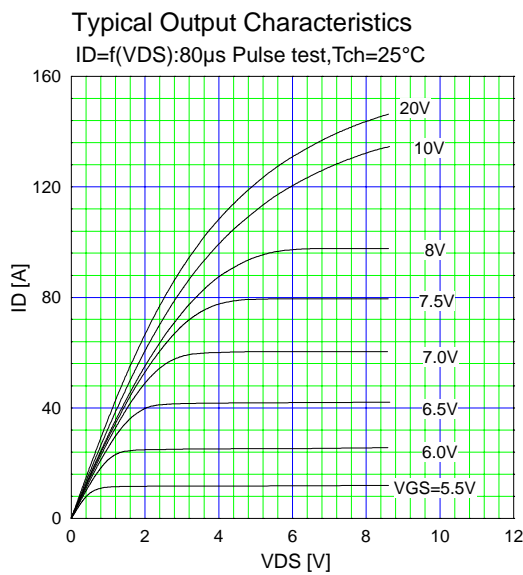
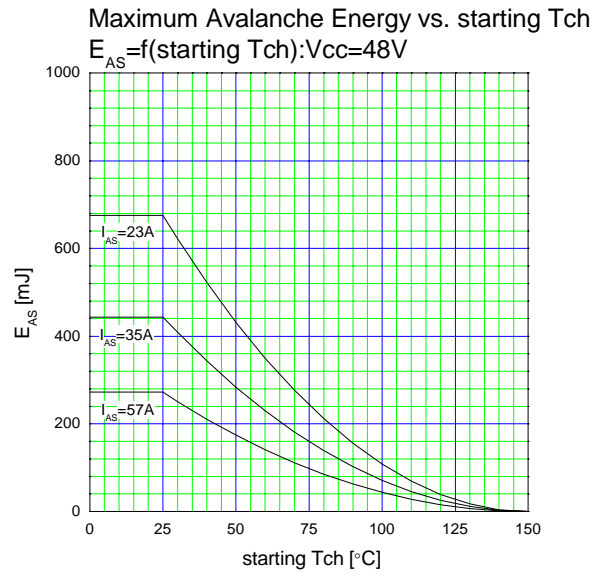
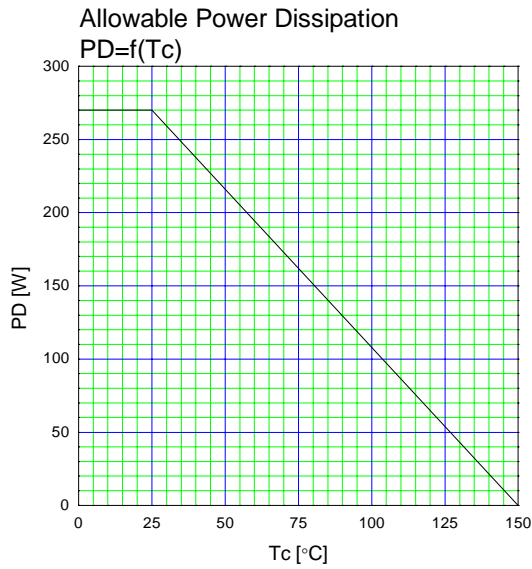

Drain-Source On-state Resistance
 $R_{DS(on)} = f(T_{ch}): I_D = 20A, V_{GS} = 10V$

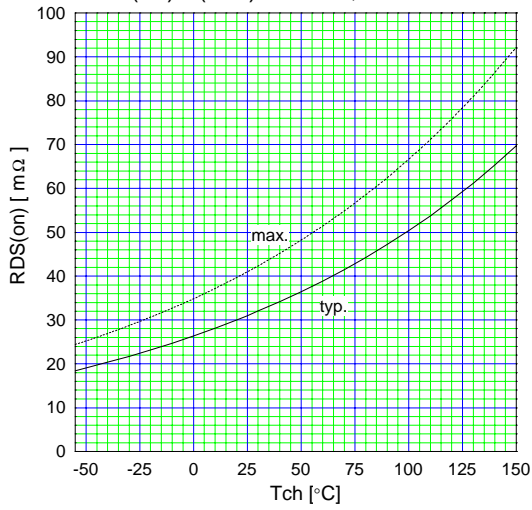

Gate Threshold Voltage vs. T_{ch}
 $V_{GS(th)} = f(T_{ch}): V_{DS} = V_{GS}, I_D = 250\mu A$

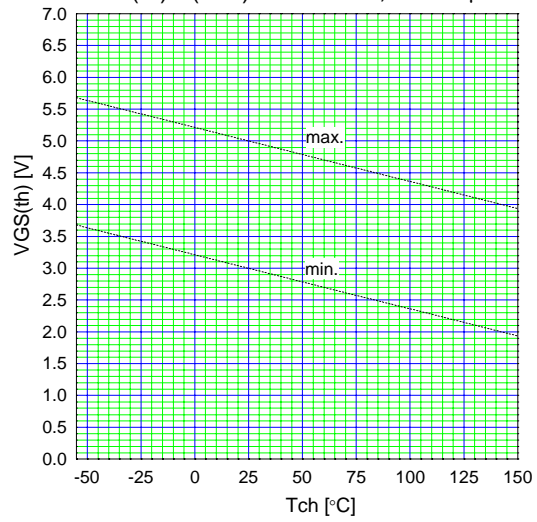

Typical Gate Charge Characteristics
 $V_{GS} = f(Q_g): I_D = 40A, T_{ch} = 25^{\circ}C$

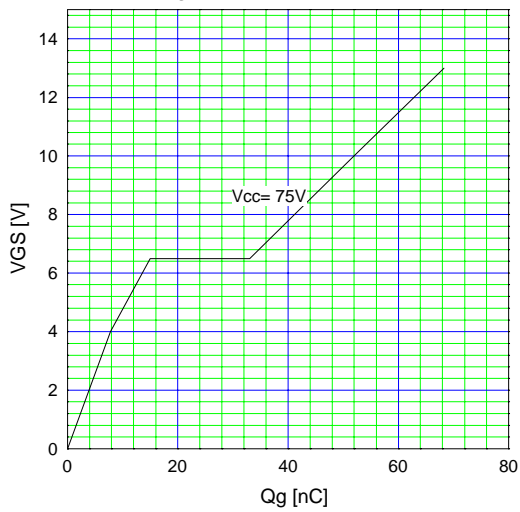

Typical Capacitance
 $C = f(V_{DS}): V_{GS} = 0V, f = 1MHz$

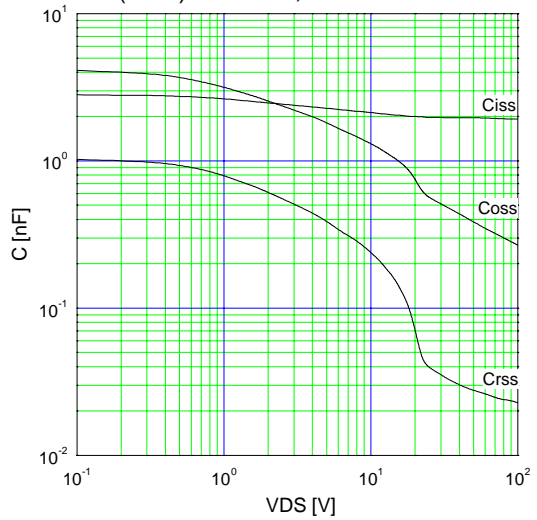

Typical Forward Characteristics of Reverse Diode
 $I_F = f(V_{SD}): 80\mu s$ Pulse test, $T_{ch} = 25^{\circ}C$

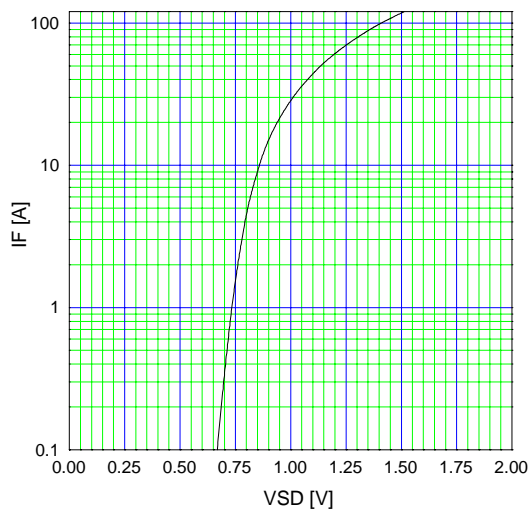

Typical Switching Characteristics vs. I_D
 $t = f(I_D): V_{CC} = 48V, V_{GS} = 10V, R_G = 10\Omega$

