

FUJI POWER MOSFET Super FAP-G Series

N-CHANNEL SILICON POWER MOSFET

■ Outline Drawings (mm)

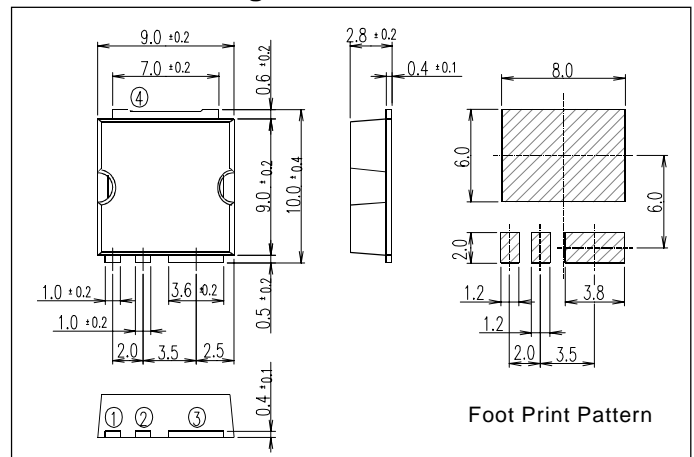

■ Features

- High speed switching
- Low on-resistance
- No secondary breakdown
- Low driving power
- Avalanche-proof

■ Applications

- Switching regulators
- UPS (Uninterruptible Power Supply)
- DC-DC converters

■ Maximum ratings and characteristic

Absolute maximum ratings

● (Tc=25°C unless otherwise specified)

Item	Symbol	Ratings	Unit
Drain-source voltage	V _{DS}	150	V
	V _{D SX} *5	120	V
Continuous drain current	I _D	T _C =25°C	±23
		T _a =25°C	±3.1 **
Pulsed drain current	I _{D(puls)}	±92	A
Gate-source voltage	V _{GS}	±30	V
Non-repetitive Avalanche current	I _{AS} *2	23	A
Maximum Avalanche Energy	E _{AS} *1	130.9	mJ
Maximum Drain-Source dV/dt	dV _{DS} /dt *4	20	kV/μs
Peak Diode Recovery dV/dt	dV/dt *3	5	kV/μs
Max. power dissipation	P _D	T _C =25°C	105
		T _a =25°C	2.4 **
Operating and storage temperature range	T _{ch}	+150	°C
	T _{stg}	-55 to +150	°C

■ Equivalent circuit schematic

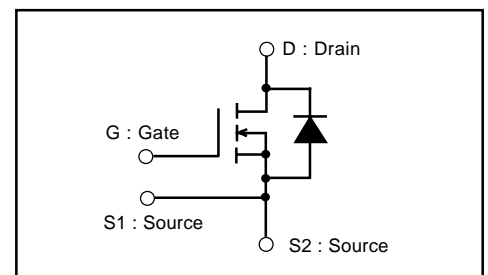

** Surface mounted on 1000mm², t=1.6mm FR-4 PCB(Drain pad area : 500mm²)

*1 L=363μH, V_{CC}=48V, T_{ch}=25°C, See to Avalanche Energy Graph *2 T_{ch} ≤ 150°C

*3 I_F ≤ -I_D, -di/dt=50A/μs, V_{CC} ≤ BV_{DSS}, T_{ch} ≤ 150°C *4 V_{DS} ≤ 150V *5 V_{GS}=-30V

● Electrical characteristics (T_C =25°C unless otherwise specified)

Item	Symbol	Test Conditions	Min.	Typ.	Max.	Units
Drain-source breakdown voltage	V _{(BR)DSS}	I _D = 250μA V _{GS} =0V	150			V
Gate threshold voltage	V _{GS(th)}	I _D = 250μA V _{DS} =V _{GS}	3.0		5.0	V
Zero gate voltage drain current	I _{DSS}	V _{DS} =150V V _{GS} =0V			25	μA
		V _{DS} =120V V _{GS} =0V			250	
Gate-source leakage current	I _{GSS}	V _{GS} =±30V V _{DS} =0V		10	100	nA
Drain-source on-state resistance	R _{DS(on)}	I _D =8A V _{GS} =10V		79	105	mΩ
Forward transconductance	g _{fs}	I _D =8A V _{DS} =25V	6	12		S
Input capacitance	C _{iss}	V _{DS} =75V		760	1140	pF
Output capacitance	C _{oss}	V _{GS} =0V		130	195	
Reverse transfer capacitance	C _{rss}	f=1MHz		6	9	
Turn-on time t _{on}	td(on)	V _{CC} =48V I _D =8A		12	18	ns
	t _r	V _{GS} =10V		2.8	4.2	
Turn-off time t _{off}	td(off)	R _{GS} =10 Ω		22	33	
	t _f			6.2	9.3	
Total Gate Charge	Q _G	V _{CC} =75V		21	31.5	nC
Gate-Source Charge	Q _{GS}	I _D =16A		9	13.5	
Gate-Drain Charge	Q _{GD}	V _{GS} =10V		6	9	
Avalanche capability	I _{AV}	L=363μH T _{ch} =25°C	23			A
Diode forward on-voltage	V _{SD}	I _F =16A V _{GS} =0V T _{ch} =25°C		1.10	1.65	V
Reverse recovery time	t _{rr}	I _F =16A V _{GS} =0V		0.13		μs
Reverse recovery charge	Q _{rr}	-di/dt=100A/μs T _{ch} =25°C		0.59		μC

● Thermal characteristics

Item	Symbol	Test Conditions	Min.	Typ.	Max.	Units
Thermal resistance	R _{th(ch-c)}	channel to case			1.191	°C/W
	R _{th(ch-a)}	channel to ambient			87.0	°C/W
	R _{th(ch-a)} **	channel to ambient			52.0	°C/W

** Surface mounted on 1000mm², t=1.6mm FR-4 PCB(Drain pad area : 500mm²)

Characteristics

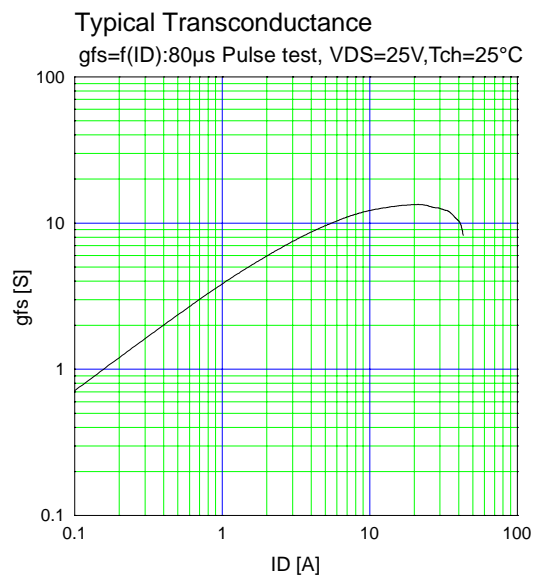
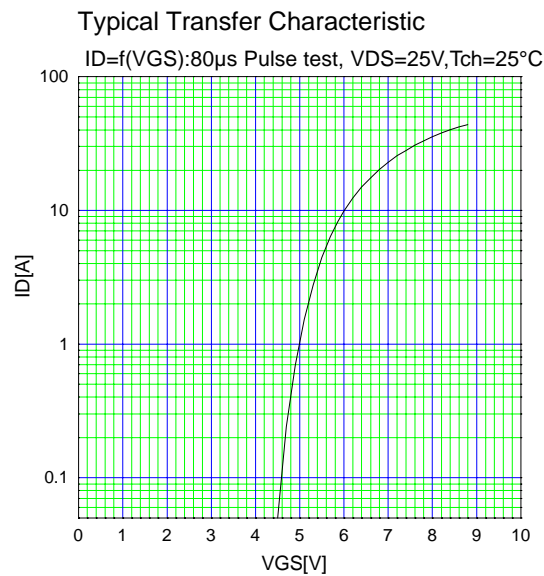
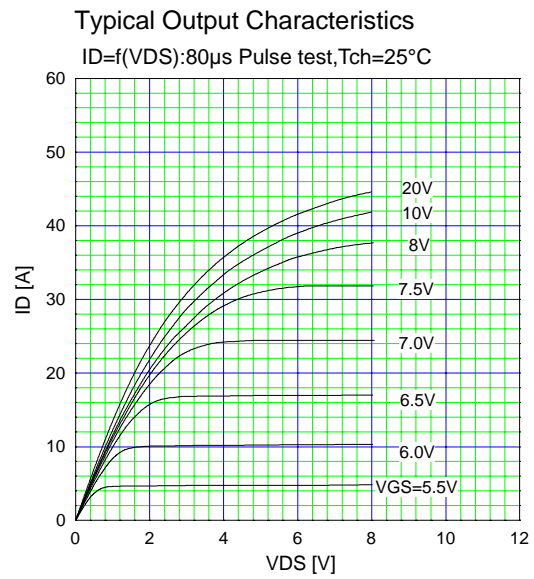
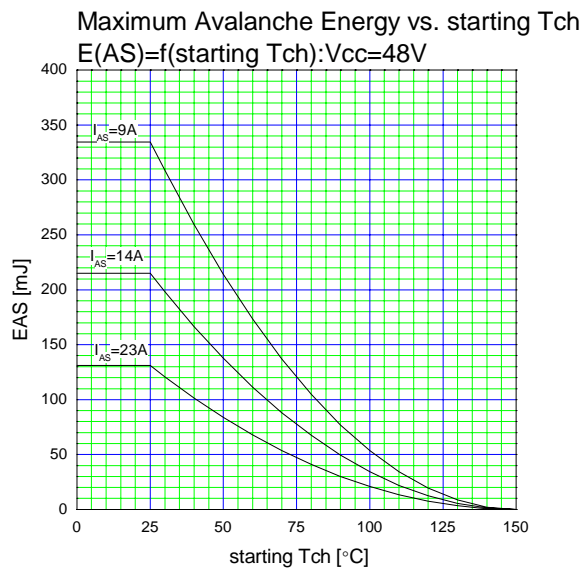
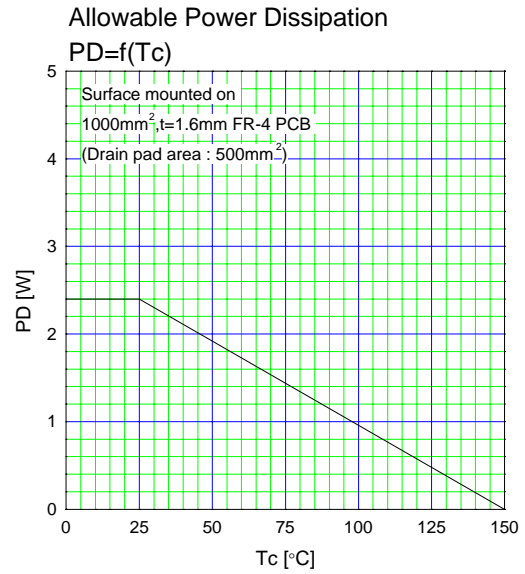
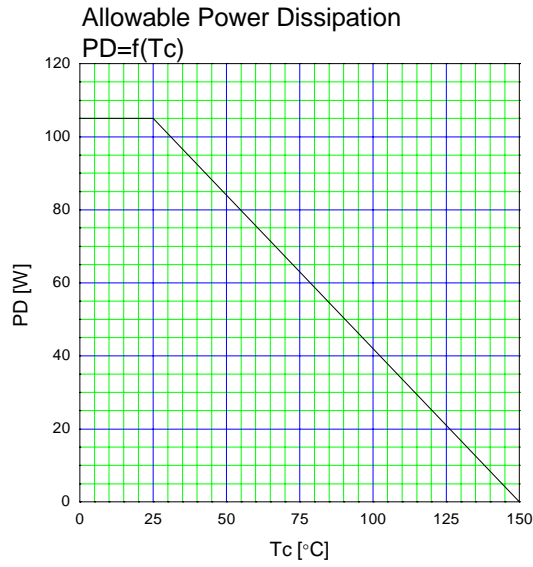

Typical Drain-Source on-state Resistance

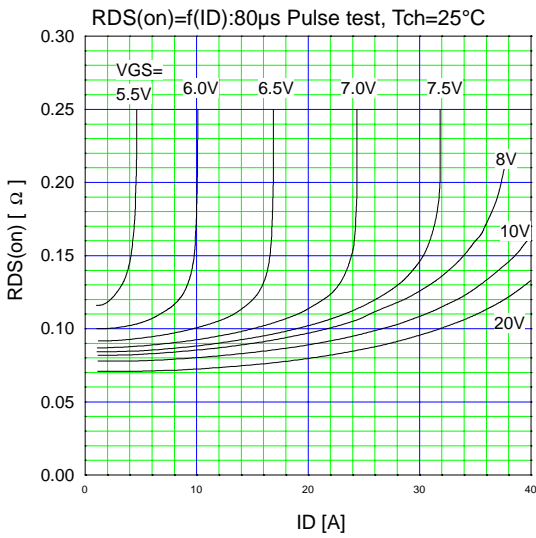

Drain-Source On-state Resistance

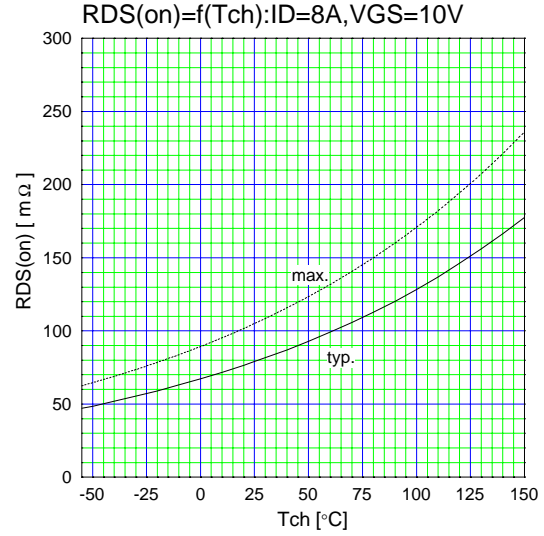

Gate Threshold Voltage vs. T_{ch}

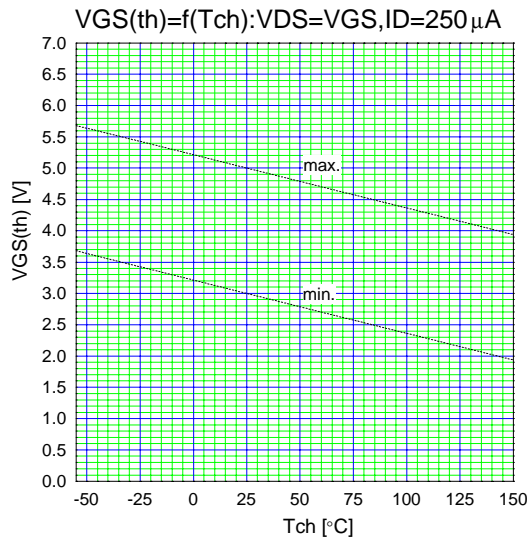

Typical Gate Charge Characteristics

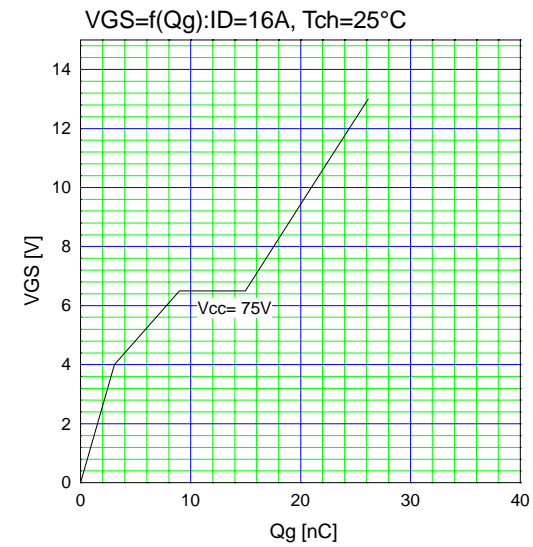

Typical Capacitance

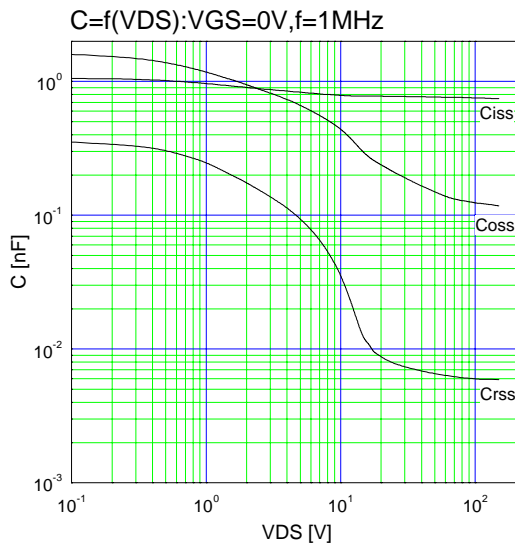

Typical Forward Characteristics of Reverse Diode

