

2SK3684-01L,S,SJ

FUJI POWER MOSFET Super FAP-G Series

N-CHANNEL SILICON POWER MOSFET

Features

- High speed switching
- Low on-resistance
- No secondary breakdown
- Low driving power
- Avalanche-proof

Applications

- Switching regulators
- DC-DC converters
- UPS (Uninterruptible Power Supply)

Maximum ratings and characteristic Absolute maximum ratings

(T_c=25°C unless otherwise specified)

Item	Symbol	Ratings	Unit	Remarks
Drain-source voltage	V _{DS}	500	V	
	V _{DSX}	500	V	V _{GS} =-30V
Continuous drain current	I _D	±19	A	
Pulsed drain current	I _{D(puls)}	±76	A	
Gate-source voltage	V _{GS}	±30	V	
Non-Repetitive Maximum avalanche current	I _{AS}	19	A	T _{ch} ≤150°C
Non-Repetitive Maximum avalanche energy	E _{AS}	245.3	mJ	L=1.25mH V _{CC} =50V *2
Maximum Drain-Source dV/dt	dV _{DS} /dt	20	kV/s	V _{DS} ≤500V
Peak diode recovery dV/dt	dV/dt	5	kV/μs	*3
Max. power dissipation	P _D	1.67	W	T _a =25°C
		270		T _c =25°C
Operating and storage temperature range	T _{ch}	+150	°C	
	T _{stg}	-55 to +150	°C	

*2 See to Avalanche Energy Graph

*3 I_F≤-I_D, -di/dt=50A/μs, V_{CC}≤BV_{DSS}, T_{ch}≤150°C

Outline Drawings [mm]

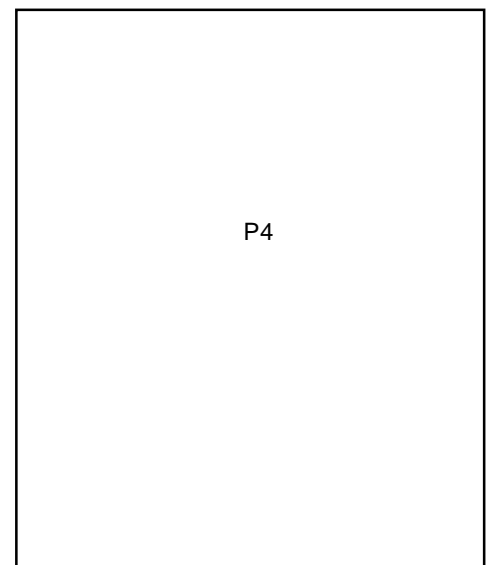

Equivalent circuit schematic

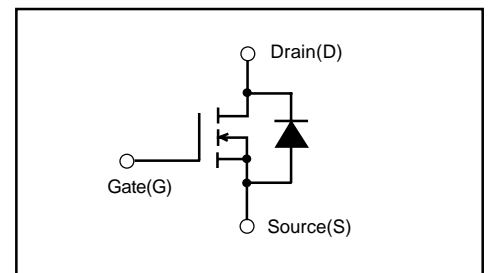

Electrical characteristics (T_c=25°C unless otherwise specified)

Item	Symbol	Test Conditions	Min.	Typ.	Max.	Units
Drain-source breakdown voltage	V _{(BR)DSS}	I _D =250μA V _{GS} =0V	500			V
Gate threshold voltage	V _{GS(th)}	I _D =250μA V _{DS} =V _{GS}	3.0		5.0	V
Zero gate voltage drain current	I _{DSS}	V _{DS} =500V V _{GS} =0V T _{ch} =25°C			25	μA
		V _{DS} =400V V _{GS} =0V T _{ch} =125°C			250	
Gate-source leakage current	I _{GSS}	V _{GS} =±30V V _{DS} =0V		10	100	nA
Drain-source on-state resistance	R _{DS(on)}	I _D =9.5A V _{GS} =10V		0.29	0.38	Ω
Forward transconductance	g _{fs}	I _D =9.5A V _{DS} =25V	7.5	15		S
Input capacitance	C _{iss}	V _{DS} =25V		1560	2340	pF
Output capacitance	C _{oss}	V _{GS} =0V		230	345	
Reverse transfer capacitance	C _{rss}	f=1MHz		8	12	
Turn-on time t _{on}	td(on)	V _{CC} =300V I _D =9.5A		29	43.5	ns
	t _r	V _{GS} =10V		13	19.5	
Turn-off time t _{off}	td(off)	R _{GS} =10Ω		56	84	
	t _f			8	12	
Total Gate Charge	Q _G	V _{CC} =250V		34	51	nC
Gate-Source Charge	Q _{GS}	I _D =19A		13	19.5	
Gate-Drain Charge	Q _{GD}	V _{GS} =10V		10	15	
Avalanche capability	I _{AV}	L=1.25mH T _{ch} =25°C	19			A
Diode forward on-voltage	V _{SD}	I _F =19A V _{GS} =0V T _{ch} =25°C		1.20	1.50	V
Reverse recovery time	t _{rr}	I _F =19A V _{GS} =0V		0.57		μs
Reverse recovery charge	Q _{rr}	-di/dt=100A/μs T _{ch} =25°C		7.0		μC

Thermal characteristics

Item	Symbol	Test Conditions	Min.	Typ.	Max.	Units
Thermal resistance	R _{th(ch-c)}	channel to case			0.463	°C/W
	R _{th(ch-a)}	channel to ambient			75.0	°C/W

Characteristics

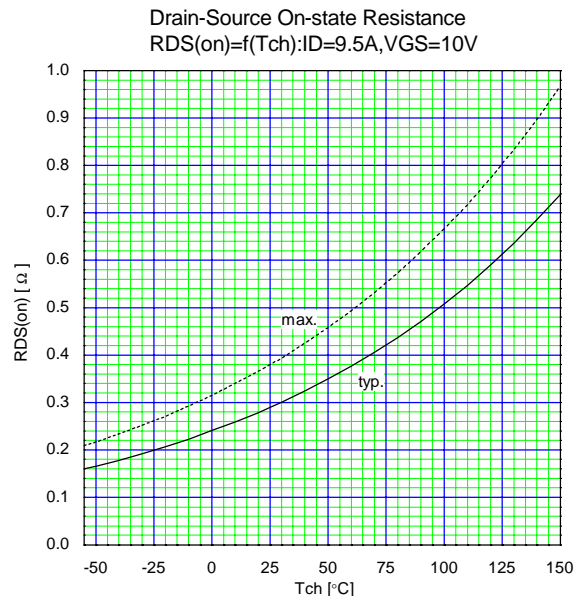
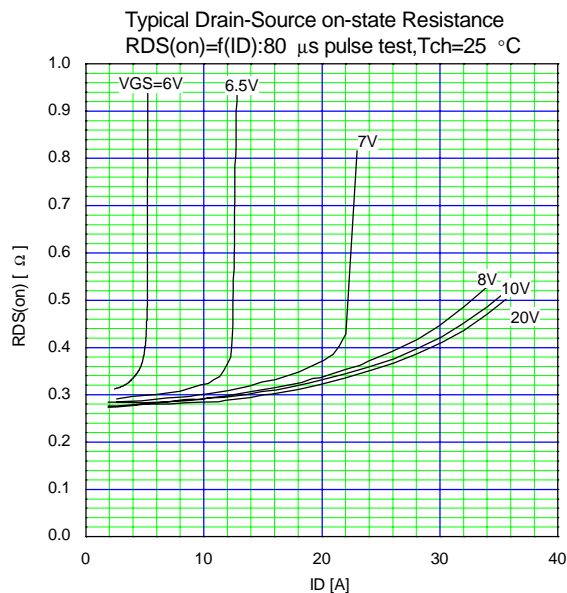
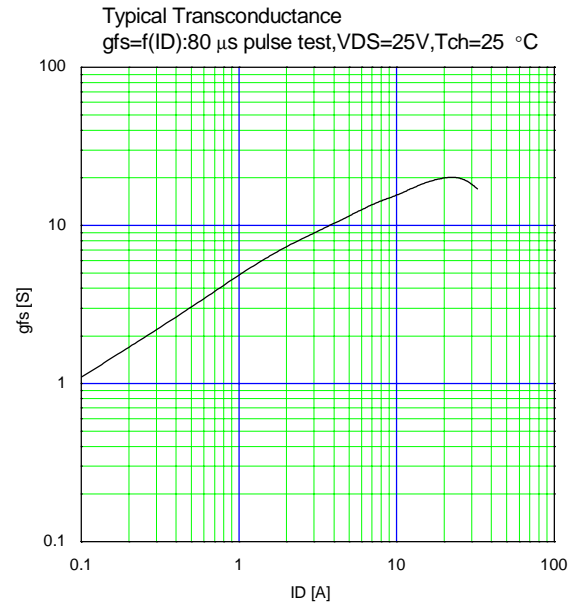
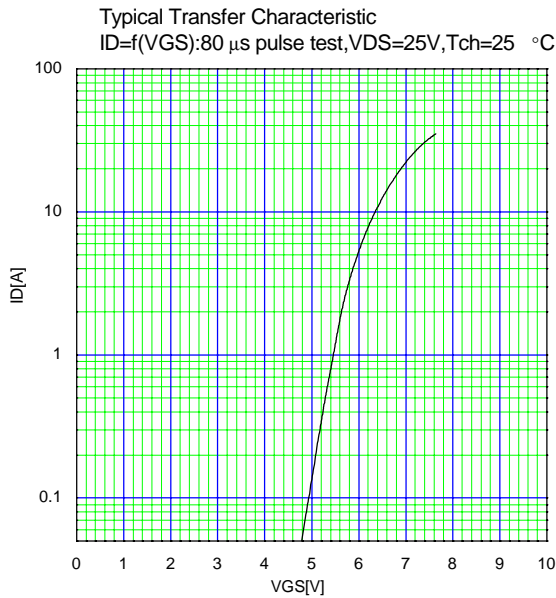
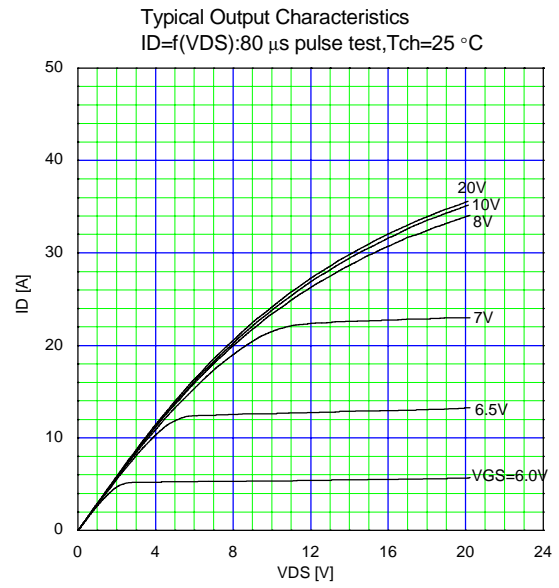
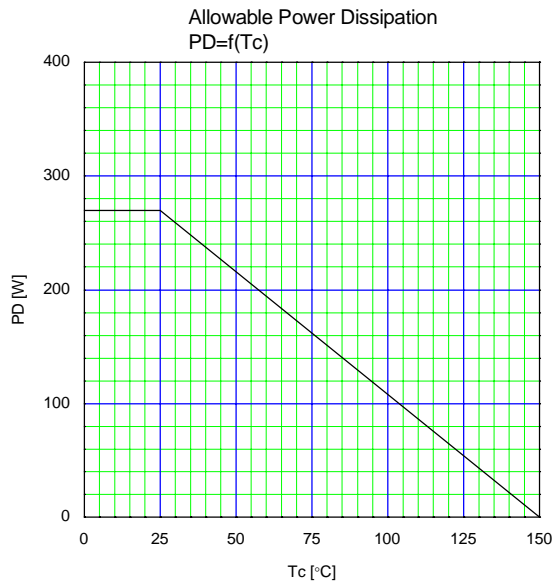

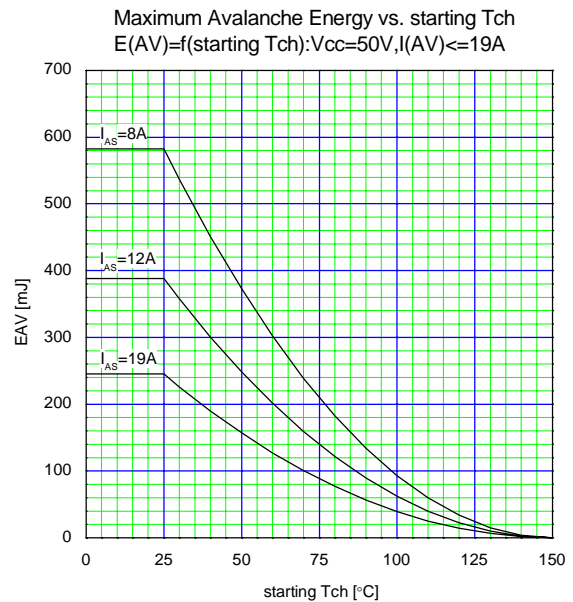
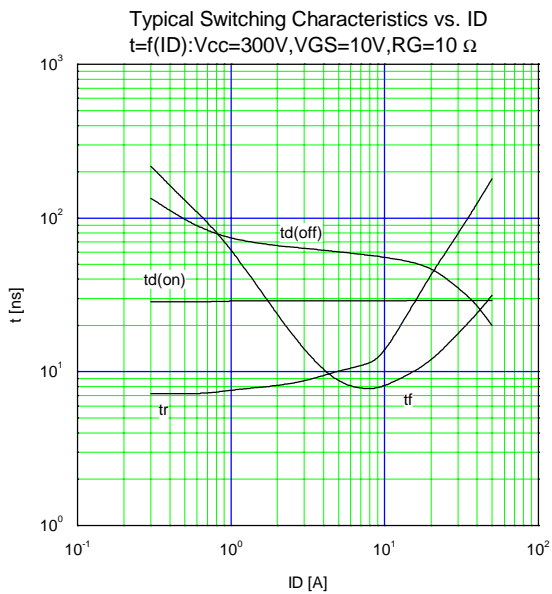
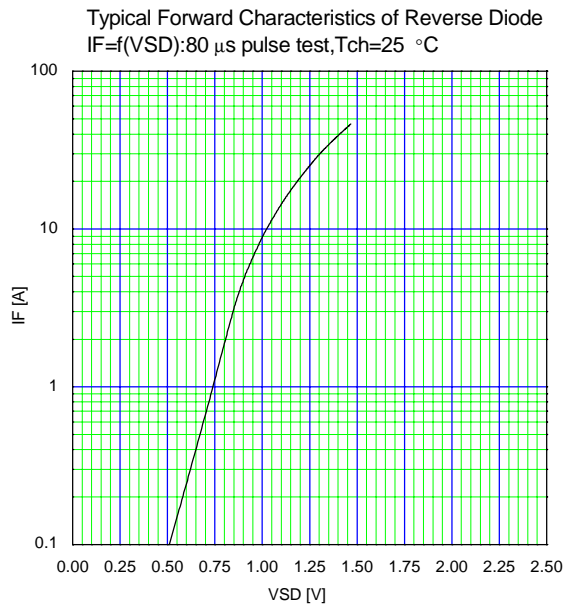
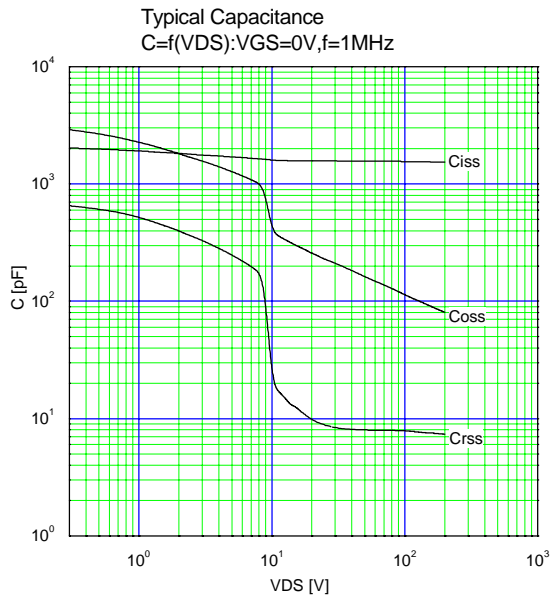
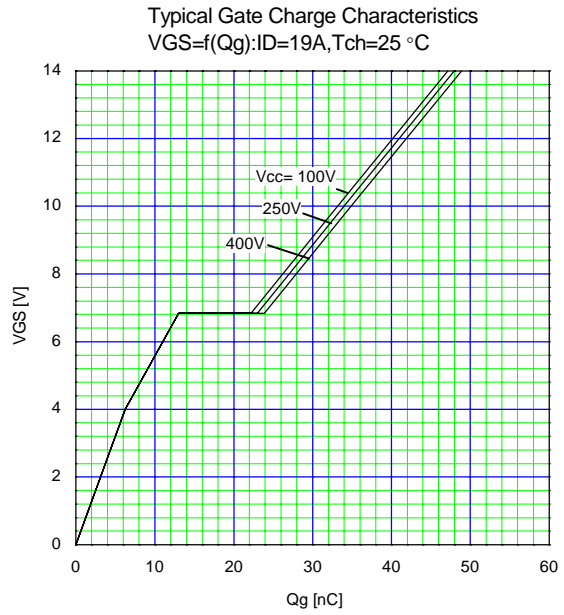
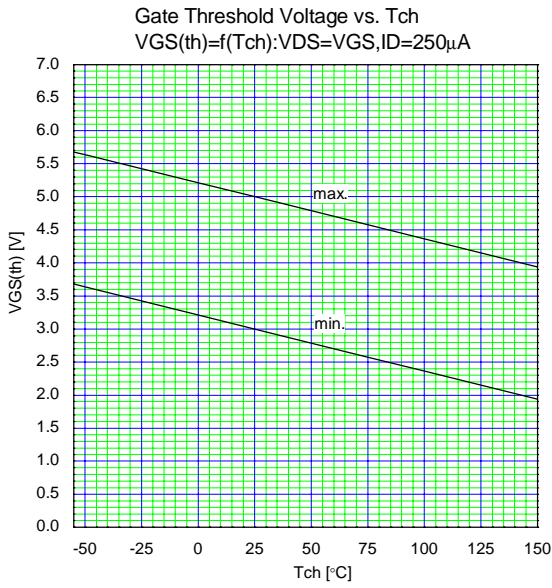

Maximum Avalanche Current Pulsewidth
 $I_{AV}=f(t_{AV})$:starting Tch=25°C,Vcc=50V

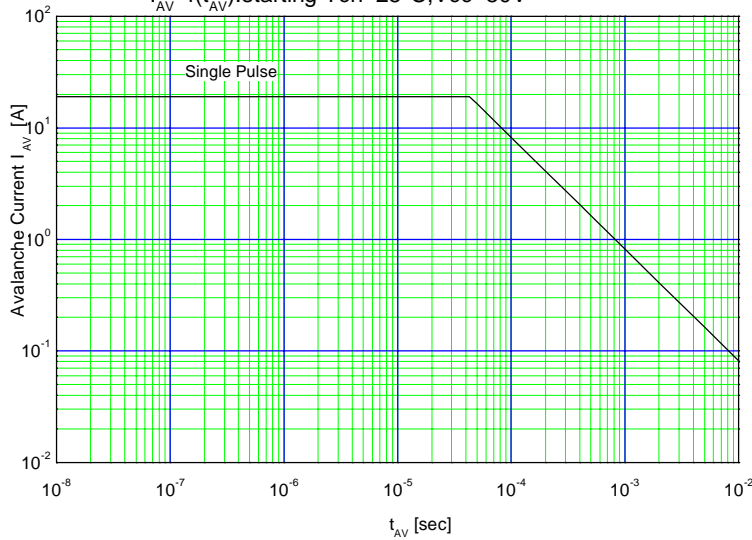

Maximum Transient Thermal Impedance
 $Z_{th}(ch-c)=f(t)$:D=0

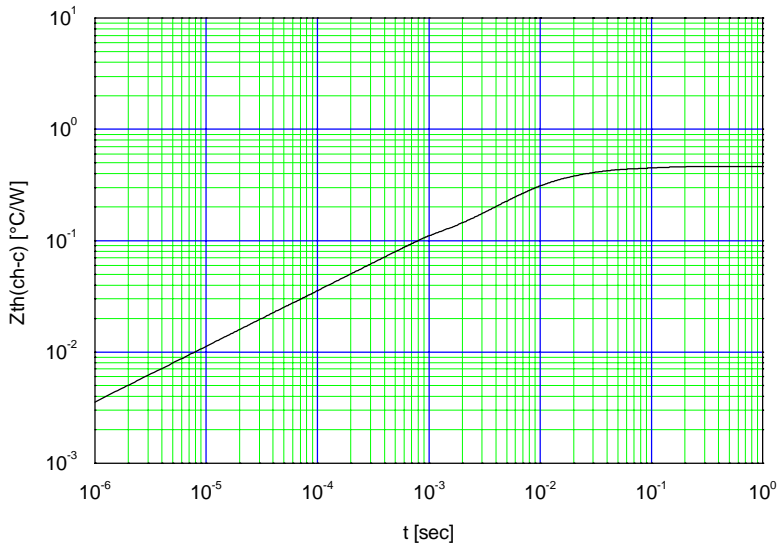

■ Outline Drawings (mm)

Type(L)

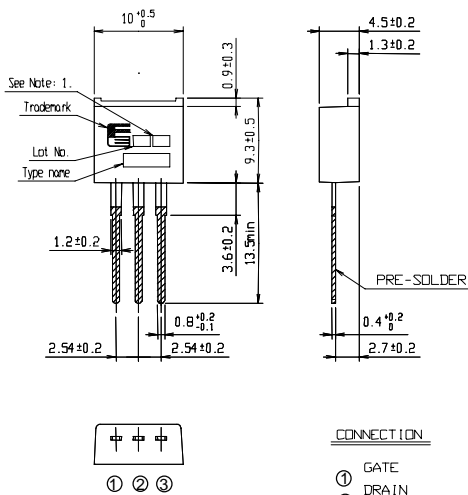

Type(S)

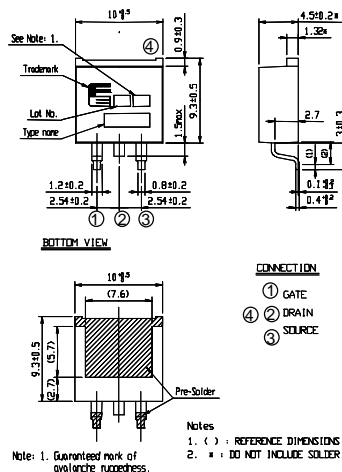

Type(SJ)

