

# SPECIFICATION

Device Name : Power MOSFET

---

Type Name : 2SK3886-01MR

---

Spec. No. : MS5F5814

---

Date : Jun-28-2004

---

This material and the information herein is the property of Fuji Electric Device Technology Co., Ltd. They shall be neither reproduced, copied, lent, or disclosed in any way whatsoever for the use of any third party nor used for the manufacturing purposes without the express written consent of Fuji Electric Device Technology Co., Ltd.

	DATE	NAME	APPROVED	
DRAWN	Jun-28-'04	T. Kuboyama	<i>y. S. di</i>	Fuji Electric Device Technology Co., Ltd.
CHECKED	Jun-28-'04	T. HOSEN		
CHECKED	Jun-28-'04	<i>K. Yamada</i>		
				DWG. NO. <span style="font-size: 1.5em; font-weight: bold;">MS5F5814</span> 1/18

# Revised Records

Date	Classification	Index	Content	Drawn	Checked	Checked	Approved
Jun-28 2004	enactment	—	—————	T. Kubozono	T. Hozumi	K. Yamada	Y. Saito
Aug.-29 2006	Revision	a	Revised RDS(on)-tch graph.	T. Kubozono	H. Aota	O. Yamada	T. Nagata

This material and the information herein is the property of Fuji Electric Device Technology Co., Ltd. They shall be neither reproduced, copied, lent, or disclosed in any way whatsoever for the use of any third party nor used for the manufacturing purposes without the express written consent of Fuji Electric Device Technology Co., Ltd.

This material and the information herein is the property of Fuji Electric Device Technology Co., Ltd. They shall be neither reproduced, copied, lent, or disclosed in any way whatsoever for the use of any third party nor used for the manufacturing purposes without the express written consent of Fuji Electric Device Technology Co., Ltd.

- 1.Scope** This specifies Fuji Power MOSFET 2SK3886-01MR
- 2.Construction** N-Channel enhancement mode power MOSFET
- 3.Applications** for Switching
- 4.Outview** TO-220F Outview See to 8/18 page

**5.Absolute Maximum Ratings at Tc=25°C (unless otherwise specified)**

Description	Symbol	Characteristics	Unit	Remarks
Drain-Source Voltage	V <sub>DS</sub>	120	V	
	V <sub>DSX</sub>	90	V	V <sub>GS</sub> =-30V
Continuous Drain Current	I <sub>D</sub>	67	A	
Pulsed Drain Current	I <sub>DP</sub>	± 268	A	
Gate-Source Voltage	V <sub>GS</sub>	± 30	V	
Repetitive and Non-repetitive Maximum Avalanche Current	I <sub>AR</sub>	67	A	Note *1
Non-Repetitive Maximum Avalanche Energy	E <sub>AS</sub>	719.1	mJ	Note *2
Repetitive Maximum Avalanche Energy	E <sub>AR</sub>	9.5	mJ	Note *3
Maximum Drain-Source dV/dt	dV <sub>DS</sub> /dt	20	kV/μs	V <sub>DS</sub> ≤120V
Peak Diode Recovery dV/dt	dV/dt	5	kV/μs	Note *4
Maximum Power Dissipation	P <sub>D</sub>	95	W	T <sub>c</sub> =25°C
		2.16		T <sub>a</sub> =25°C
Operating and Storage Temperature range	T <sub>ch</sub>	150	°C	
	T <sub>stg</sub>	-55 to +150	°C	
Isolation Voltage	V <sub>ISO</sub>	2	kVrms	t=60sec f=60Hz

**6.Electrical Characteristics at Tc=25°C (unless otherwise specified)**

**Static Ratings**

Description	Symbol	Conditions	min.	typ.	max.	Unit
Drain-Source Breakdown Voltage	BV <sub>DSS</sub>	I <sub>D</sub> =250μA V <sub>GS</sub> =0V	120	-	-	V
Gate Threshold Voltage	V <sub>GS(th)</sub>	I <sub>D</sub> =250μA V <sub>DS</sub> =V <sub>GS</sub>	3.0	-	5.0	V
Zero Gate Voltage Drain Current	I <sub>DSS</sub>	V <sub>DS</sub> =120V V <sub>GS</sub> =0V T <sub>ch</sub> =25°C	-	-	25	μA
		V <sub>DS</sub> =96V V <sub>GS</sub> =0V T <sub>ch</sub> =125°C	-	-	250	
Gate-Source Leakage Current	I <sub>GSS</sub>	V <sub>GS</sub> = ± 30V V <sub>DS</sub> =0V	-	-	100	nA
Drain-Source On-State Resistance	R <sub>DS(on)</sub>	I <sub>D</sub> =33.5A V <sub>GS</sub> =10V	-	24.6	30.0	mΩ

### Dynamic Ratings

Description	Symbol	Conditions	min.	typ.	max.	Unit
Forward Transconductance	$g_{fs}$	$I_D=33.5A$ $V_{DS}=25V$	14	28	-	S
Input Capacitance	$C_{iss}$	$V_{DS}=75V$	-	1880	2820	pF
Output Capacitance	$C_{oss}$	$V_{GS}=0V$	-	360	540	
Reverse Transfer Capacitance	$C_{rss}$	$f=1MHz$	-	30	45	
Turn-On Time	$t_d(on)$	$V_{cc}=48V$	-	20	30	ns
	$t_r$	$V_{GS}=10V$	-	35	53	
Turn-Off Time	$t_d(off)$	$I_D=33.5A$	-	50	75	
	$t_f$	$R_{GS}=10\Omega$	-	23	35	
Total Gate Charge	$Q_G$	$V_{cc}=60V$	-	52	78	nC
Gate-Source Charge	$Q_{GS}$	$I_D=67A$	-	16	24	
Gate-Drain Charge	$Q_{GD}$	$V_{GS}=10V$	-	18	27	

### Reverse Diode

Description	Symbol	Conditions	min.	typ.	max.	Unit
Diode Forward On-Voltage	$V_{SD}$	$I_F=67A$ $V_{GS}=0V$ $T_{ch}=25^\circ C$	-	1.10	1.50	V
Reverse Recovery Time	$t_{rr}$	$I_F=67A$ $V_{GS}=0V$	-	150	-	ns
Reverse Recovery Charge	$Q_{rr}$	$-di/dt=100A/\mu s$ $T_{ch}=25^\circ C$	-	0.9	-	$\mu C$

### 7. Thermal Resistance

Description	Symbol	min.	typ.	max.	Unit
Channel to Case	$R_{th}(ch-c)$			1.316	$^\circ C/W$
Channel to Ambient	$R_{th}(ch-a)$			58	$^\circ C/W$

Note \*1 :  $T_{ch} \leq 150^\circ C$ , See Fig.1 and Fig.2

Note \*2 : Starting  $T_{ch}=25^\circ C$ ,  $I_{AS}=27A$ ,  $L=1.32mH$ ,  $V_{cc}=48V$ ,  $R_G=50\Omega$ , See Fig.1 and Fig.2

$E_{AS}$  limited by maximum channel temperature and avalanche current.

See to the 'Avalanche Energy' graph of page 17/18.

Note \*3 : Repetitive rating : Pulse width limited by maximum channel temperature.

See to the 'Maximum Transient Thermal impedance' graph of page 18/18.

Note \*4 :  $I_F \leq I_D$ ,  $-di/dt=50A/\mu s$ ,  $V_{cc} \leq BV_{DSS}$ ,  $T_{ch} \leq 150^\circ C$

This material and the information herein is the property of Fuji Electric Device Technology Co., Ltd. They shall be neither reproduced, copied, lent, or disclosed in any way whatsoever for the use of any third party nor used for the manufacturing purposes without the express written consent of Fuji Electric Device Technology Co., Ltd.

Fig.1 Test circuit

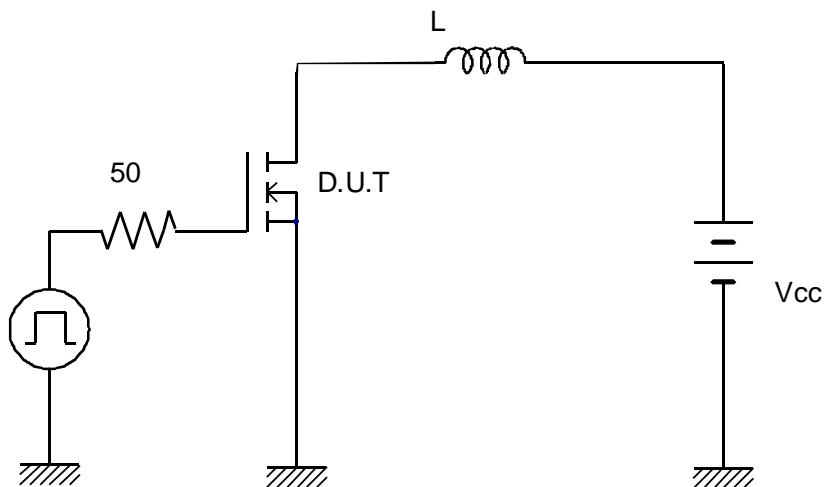
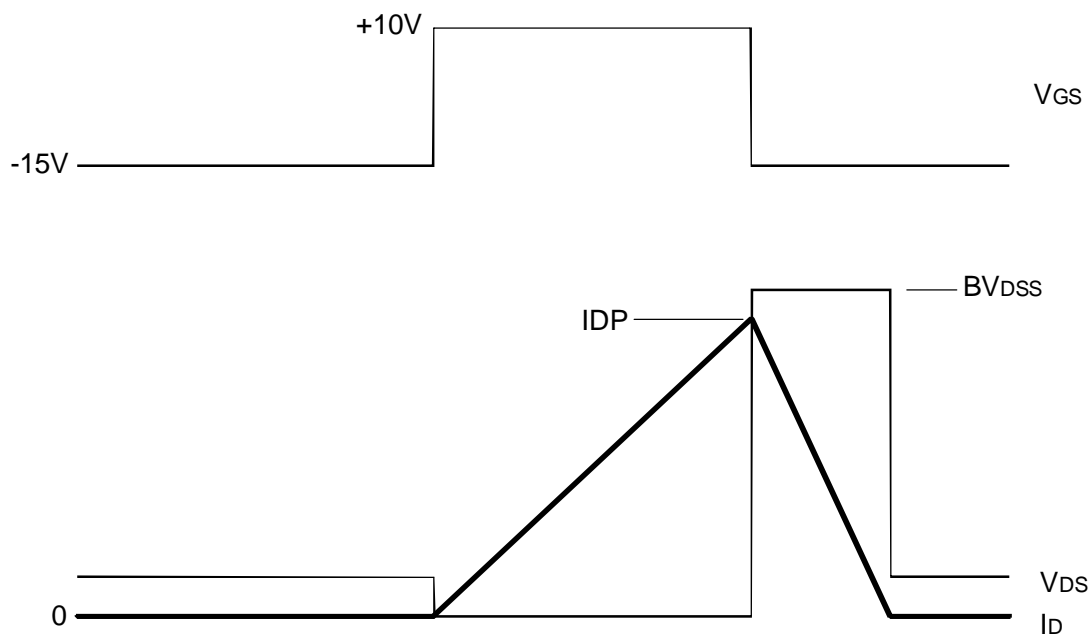

Fig.2 Operating waveforms



### 8. Reliability test items

All guaranteed values are under the categories of reliability per non-assembled(only MOSFETs). Each categories under the guaranteed reliability conform to EIAJ ED4701/100 method104 standards.

( Test items required without fail  
Humidification treatment (85±2°C,65±5%RH,168±24hr)  
Heat treatment of soldering (Solder Dipping,260±5°C(265°Cmax.),10±1sec,2 times) )

	Test No.	Test Items	Testing methods and Conditions	Reference Standard	Sampling number	Acceptance number
<b>Mechanical test methods</b>	1	Terminal Strength (Tensile)	Pull force TO-220,TO-220F : 10N TO-3P,TO-3PF,TO-247 : 25N TO-3PL : 45N T-Pack,K-Pack : 10N Force maintaining duration : 30±5sec	EIAJ ED4701/400 method 401	15	(0:1)
	2	Terminal Strength (Bending)	Load force TO-220,TO-220F : 5N TO-3P,TO-3PF,TO-247 : 10N TO-3PL : 15N T-Pack,K-Pack : 5N Number of times : 2times(90deg./time)	EIAJ ED4701/400 method 401	15	
	3	Mounting Strength	Screwing torque value: (M3) TO-220,TO-220F : 40±10Ncm TO-3P,TO-3PF,TO-247 : 50±10Ncm TO-3PL : 70±10Ncm	EIAJ ED4701/400 method 402	15	
	4	Vibration	frequency : 100Hz to 2kHz Acceleration : 200m/s <sup>2</sup> Sweeping time : 4min. 48min. for each X,Y&Z directions.	EIAJ ED4701/400 method 403	15	
	5	Shock	Peak amplitude: 15km/s <sup>2</sup> Duration time : 0.5ms 3times for each X,Y&Z directions.	EIAJ ED4701/400 method 404	15	
	6	Solderability	Solder temp. : 235±5°C Immersion time : 5±0.5sec Each terminal shall be immersed in the solder bath within 1 to 1.5mm from the body.	EIAJ ED4701/300 method 303	15	
	7	Resistance to Soldering Heat	Solder temp. : 260±5°C Immersion time : 10±1sec Number of times : 1times	EIAJ ED4701/300 method 302	15	

This material and the information herein is the property of Fuji Electric Device Technology Co., Ltd. They shall be neither reproduced, copied, lent, or disclosed in any way whatsoever for the use of any third party nor used for the manufacturing purposes without the express written consent of Fuji Electric Device Technology Co., Ltd.

This material and the information herein is the property of Fuji Electric Device Technology Co., Ltd. They shall be neither reproduced, copied, lent, or disclosed in any way whatsoever for the use of any third party nor used for the manufacturing purposes without the express written consent of Fuji Electric Device Technology Co., Ltd.

	Test No.	Test Items	Testing methods and Conditions	Reference Standard	Sampling number	Acceptance number
Climatic test methods	1	High Temp. Storage	Temperature : 150+0/-5°C Test duration : 1000hr	EIAJ ED4701/200 method 201	22	(0:1)
	2	Low Temp. Storage	Temperature : -55+5/-0°C Test duration : 1000hr	EIAJ ED4701/200 method 202	22	
	3	Temperature Humidity Storage	Temperature : 85±2°C Relative humidity : 85±5% Test duration : 1000hr	EIAJ ED4701/100 method 103	22	
	4	Temperature Humidity BIAS	Temperature : 85±2°C Relative humidity : 85±5% Bias Voltage : $V_{DS(max)} * 0.8$ Test duration : 1000hr	EIAJ ED4701/100 method 103	22	
	5	Unsaturated Pressurized Vapor	Temperature : 130±2°C Relative humidity : 85±5% Vapor pressure : 230kPa Test duration : 48hr	EIAJ ED4701/100 method 103	22	
	6	Temperature Cycle	High temp.side : 150±5°C/30min. Low temp.side : -55±5°C/30min. RT : 5°C ~ 35°C/5min. Number of cycles : 100cycles	EIAJ ED4701/100 method 105	22	
	7	Thermal Shock	Fluid : pure water(running water) High temp.side : 100+0/-5°C Low temp.side : 0+5/-0°C Duration time : HT 5min,LT 5min Number of cycles : 100cycles	EIAJ ED4701/300 method 307	22	
Endurance test methods	8	Intermittent Operating Life	$\Delta T_c=90$ degree $T_{ch} \leq T_{ch(max)}$ Test duration : 3000 cycle	EIAJ ED4701/100 method 106	22	(0:1)
	9	HTRB (Gate-source)	Temperature : $T_{ch}=150+0/-5^\circ C$ Bias Voltage : $+V_{GS(max)}$ Test duration : 1000hr	EIAJ ED4701/100 method 101	22	
	10	HTRB (Drain-Source)	Temperature : $T_{ch}=150+0/-5^\circ C$ Bias Voltage : $V_{DS(max)}*1.0$ Test duration : 1000hr	EIAJ ED4701/100 method 101	22	

#### Failure Criteria

	Item	Symbols	Failure Criteria		Unit
			Lower Limit	Upper Limit	
Electrical Characteristics	Breakdown Voltage	BVDSS	LSL * 1.0	-----	V
	Zero gate Voltage Drain-Source Current	IDSS	-----	USL * 2	A
	Gate-Source Leakage Current	IGSS	-----	USL * 2	A
	Gate Threshold Voltage	VGS(th)	LSL * 0.8	USL * 1.2	V
	Drain-Source on-state Resistance	RDS(on)	-----	USL * 1.2	$\Omega$
	Forward Transconductance	gfs	LSL * 0.8	-----	S
	Diode forward on-Voltage	VSD	-----	USL * 1.2	V
Outvie w	Marking Soldering and other damages	-----	With eyes or Microscope		-----

\* LSL : Lower Specification Limit

\* USL : Upper Specification Limit

\* Before any of electrical characteristics measure, all testing related to the humidity have conducted after drying the package surface for more than an hour at 150°C.

Fuji Electric Device Technology Co.,Ltd

DWG.NO.

MS5F5814

7/18

a

# FUJI POWER MOS FET

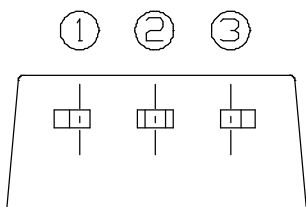
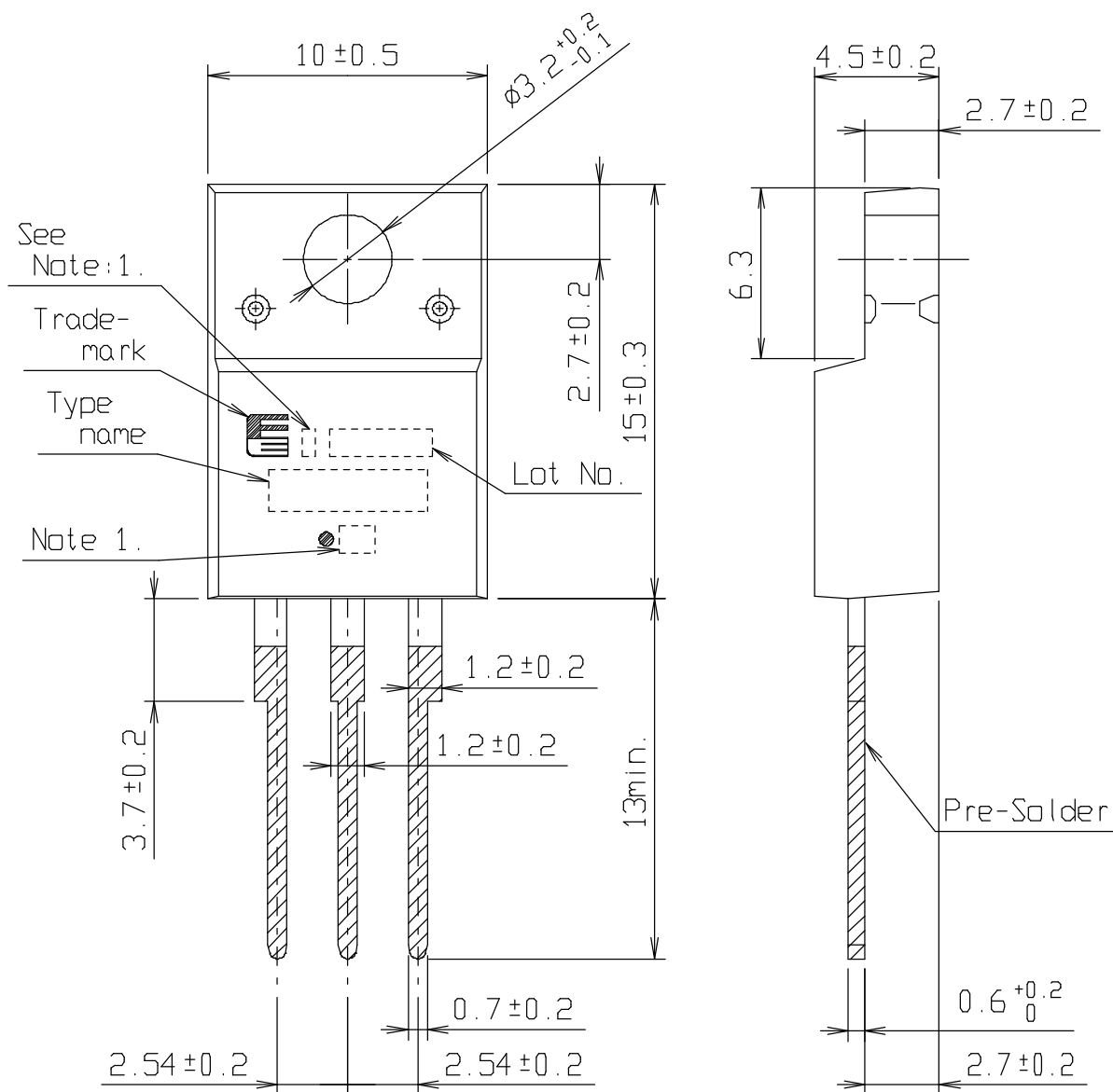

## CONNECTION

- ① GATE
- ② DRAIN
- ③ SOURCE

Note 1. Country of origin mark.  
 · No mark is Made in JAPAN.  
 · "P" is Made in Philippines.  
 2. Guaranteed mark of avalanche reggedness.

DIMENSIONS ARE IN MILLIMETERS.

This material and the information herein is the property of Fuji Electric Device Technology Co., Ltd. They shall be neither reproduced, copied, lent, or disclosed in any way whatsoever for the use of any third party nor used for the manufacturing purposes without the express written consent of Fuji Electric Device Technology Co., Ltd.



This material and the information herein is the property of Fuji Electric Device Technology Co., Ltd. They shall be neither reproduced, copied, lent, or disclosed in any way whatsoever for the use of any third party nor used for the manufacturing purposes without the express written consent of Fuji Electric Device Technology Co., Ltd.

## 9. Cautions

- Although Fuji Electric is continually improving product quality and reliability, a small percentage of semiconductor products may become faulty. When using Fuji Electric semiconductor products in your equipment, you are requested to take adequate safety measures to prevent the equipment from causing physical injury, fire, or other problem in case any of the products fail. It is recommended to make your design fail-safe, flame retardant, and free of malfunction.
- The products described in this Specification are intended for use in the following electronic and electrical equipment which has normal reliability requirements.
  - Computers                      • OA equipment                      • Communications equipment(Terminal devices)
  - Machine tools                 • AV equipment                      • Measurement equipment
  - Personal equipment         • Industrial robots                 • Electrical home appliances etc.
- The products described in this Specification are not designed or manufactured to be used in equipment or systems used under life-threatening situations. If you are considering using these products in the equipment listed below, first check the system construction and required reliability, and take adequate safety measures such as a backup system to prevent the equipment from malfunctioning.
  - Backbone network equipment                      • Transportation equipment (automobiles, trains, ships, etc.)
  - Traffic-signal control equipment                 • Gas alarms, leakage gas auto breakers
  - Submarine repeater equipment                   • Burglar alarms, fire alarms, emergency equipment
  - Medical equipment                                   • Nuclear control equipment etc.
- Do not use the products in this Specification for equipment requiring strict reliability such as (but not limited to):
  - Aerospace equipment                      • Aeronautical equipment

## 10. Warnings

- The MOSFETs should be used in products within their absolute maximum rating(voltage, current, temperature, etc.).
- The MOSFETs may be destroyed if used beyond the rating.
- We only guarantee the non-repetitive and repetitive Avalanche capability and not for the continuous Avalanche capability which can be assumed as abnormal condition .Please note the device may be destructed from the Avalanche over the specified maximum rating.
- The equipment containing MOSFETs should have adequate fuses or circuit breakers to prevent the equipment from causing secondary destruction (ex. fire, explosion etc...).
- Use the MOSFETs within their reliability and lifetime under certain environments or conditions. The MOSFETs may fail before the target lifetime of your products if used under certain reliability conditions.
- Be careful when handling MOSFETs for ESD damage. (It is an important consideration.)
- When handling MOSFETs, hold them by the case (package) and don't touch the leads and terminals.
- It is recommended that any handling of MOSFETs is done on grounded electrically conductive floor and tablemats.

- Before touching a MOSFET terminal, Discharge any static electricity from your body and clothes by grounding out through a high impedance resistor (about 1MΩ)
- When soldering, in order to protect the MOSFETs from static electricity, ground the soldering iron or soldering bath through a low impedance resistor.
- You must design the MOSFETs to be operated within the specified maximum ratings(voltage, current, temperature, etc.) to prevent possible failure or destruction of devices.
- Consider the possible temperature rise not only for the channel and case, but also for the outer leads.
- Do not directly touch the leads or package of the MOSFETs while power is supplied or during operation in order to avoid electric shock and burns.
- The MOSFETs are made of incombustible material. However, if a MOSFET fails, it may emit smoke or flame. Also, operating the MOSFETs near any flammable place or material may cause the MOSFETs to emit smoke or flame in case the MOSFETs become even hotter during operation. Design the arrangement to prevent the spread of fire.
- The MOSFETs should not used in an environment in the presence of acid, organic matter, or corrosive gas(hydrogen sulfide, sulfurous acid gas etc.)
- The MOSFETs should not used in an irradiated environment since they are not radiation-proof.

#### Installation

- Soldering involves temperatures which exceed the device storage temperature rating. To avoid device damage and to ensure reliability, observe the following guidelines from the quality assurance standard.

#### Solder temperature and duration (through-hole package)

Solder temperature	Duration
260±5 °C	10±1 seconds
350±10 °C	3.5±0.5 seconds

- The immersion depth of the lead should basically be up to the lead stopper and the distance should be a maximum of 1.5mm from the device.
- When flow-soldering, be careful to avoid immersing the package in the solder bath.
- Refer to the following torque reference when mounting the device on a heat sink. Excess torque applied to the mounting screw causes damage to the device and weak torque will increase the thermal resistance, both of which conditions may destroy the device.

Table 1: Recommended tightening torques.

Package style	Screw	Tightening torques	Note
TO-220 TO-220F	M3	30 – 50 Ncm	flatness : < ±30μm roughness : <10μm Plane off the edges : C<1.0mm
TO-3P TO-3PF TO-247	M3	40 – 60 Ncm	
TO-3PL	M3	60 –80 Ncm	

- The heat sink should have a flatness within  $\pm 30\mu\text{m}$  and roughness within  $10\mu\text{m}$ . Also, keep the tightening torque within the limits of this specification.
- Improper handling may cause isolation breakdown leading to a critical accident.  
ex.) Over plane off the edges of screw hole. (Recommended plane off the edge is  $C < 1.0\text{mm}$ )
- We recommend the use of thermal compound to optimize the efficiency of heat radiation. It is important to evenly apply the compound and to eliminate any air voids.

### Storage

- The MOSFETs must be stored at a standard temperature of 5 to 35°C and relative humidity of 45 to 75%.
- If the storage area is very dry, a humidifier may be required. In such a case, use only deionized water or boiled water, since the chlorine in tap water may corrode the leads.
- The MOSFETs should not be subjected to rapid changes in temperature to avoid condensation on the surface of the MOSFETs. Therefore store the MOSFETs in a place where the temperature is steady.
- The MOSFETs should not be stored on top of each other, since this may cause excessive external force on the case.
- The MOSFETs should be stored with the lead terminals remaining unprocessed. Rust may cause presoldered connections to fail during later processing.
- The MOSFETs should be stored in antistatic containers or shipping bags.

## 11. Appendix

- These products do not contain PBBs (Polybrominated Biphenyl) or PBDEs (Polybrominated Diphenyl Ether).
- These products do not contain Class-I ODS and Class-II ODS of 'Clean Air Act of US'.

- 
- If you have any questions about any part of this Specification, please contact Fuji Electric or its sales agent before using the product.
  - Neither Fuji nor its agents shall be held liable for any injury caused by using the products not in accordance with the instructions.
  - The application examples described in this specification are merely typical uses of Fuji Electric products.
  - This specification does not confer any industrial property rights or other rights, nor constitute a license for such rights.
-

This material and the information herein is the property of Fuji Electric Device Technology Co., Ltd. They shall be neither reproduced, copied, lent, or disclosed in any way whatsoever for the use of any third party nor used for the manufacturing purposes without the express written consent of Fuji Electric Device Technology Co., Ltd.

### Allowable Power Dissipation PD=f(Tc)

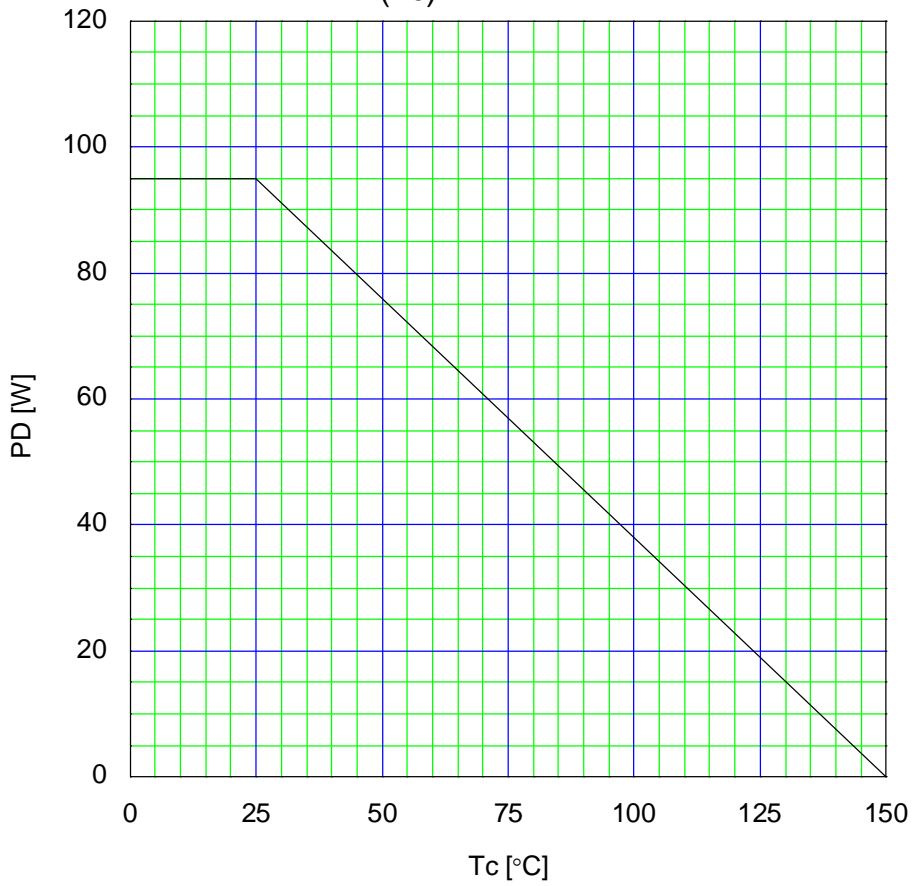

### Typical Output Characteristics ID=f(VDS):80 μs pulse test, Tch=25 °C

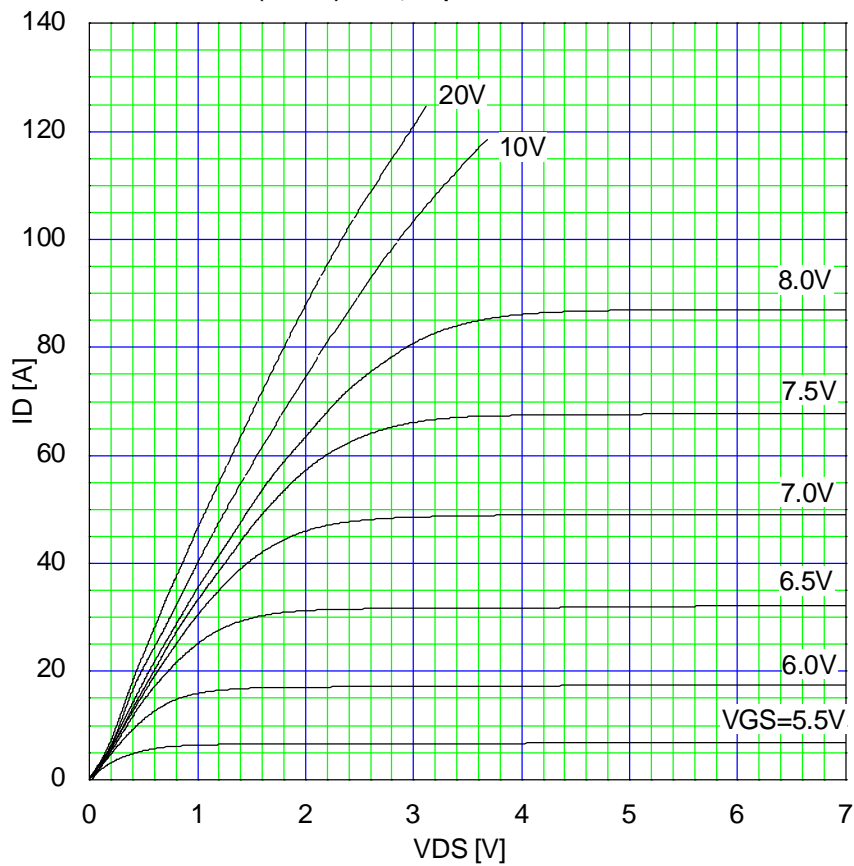

This material and the information herein is the property of Fuji Electric Device Technology Co., Ltd. They shall be neither reproduced, copied, lent, or disclosed in any way whatsoever for the use of any third party nor used for the manufacturing purposes without the express written consent of Fuji Electric Device Technology Co., Ltd.

Typical Transfer Characteristic  
 $I_D=f(V_{GS}):80\ \mu\text{s pulse test}, V_{DS}=25\text{V}, T_{ch}=25\ \text{°C}$

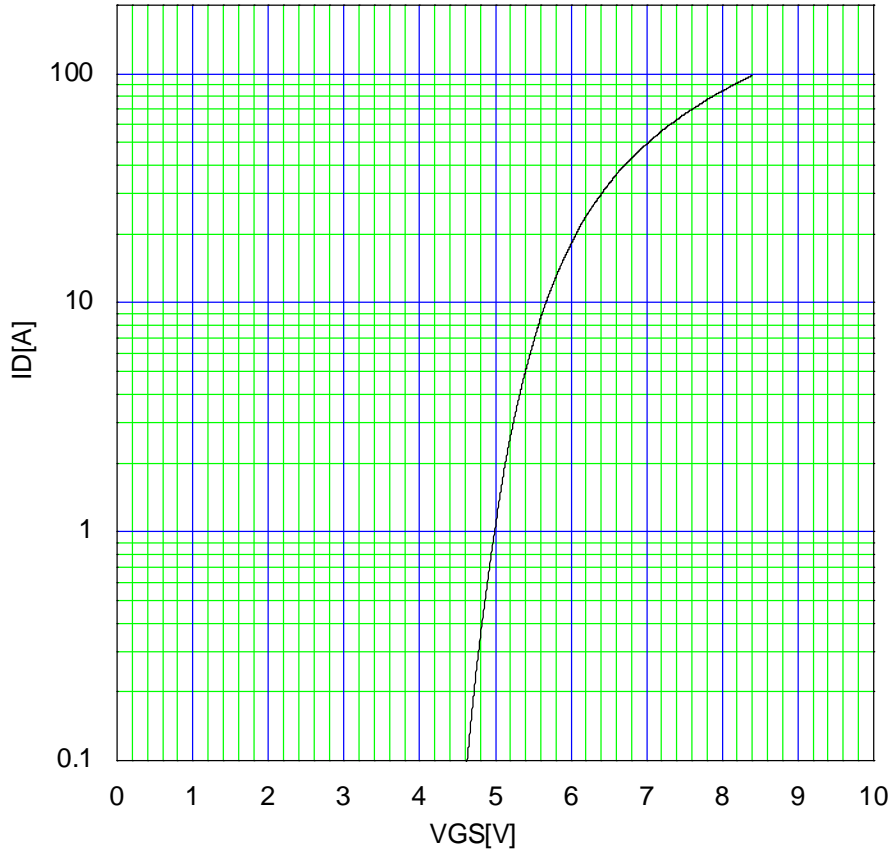

Typical Transconductance  
 $g_{fs}=f(I_D):80\ \mu\text{s pulse test}, V_{DS}=25\text{V}, T_{ch}=25\ \text{°C}$

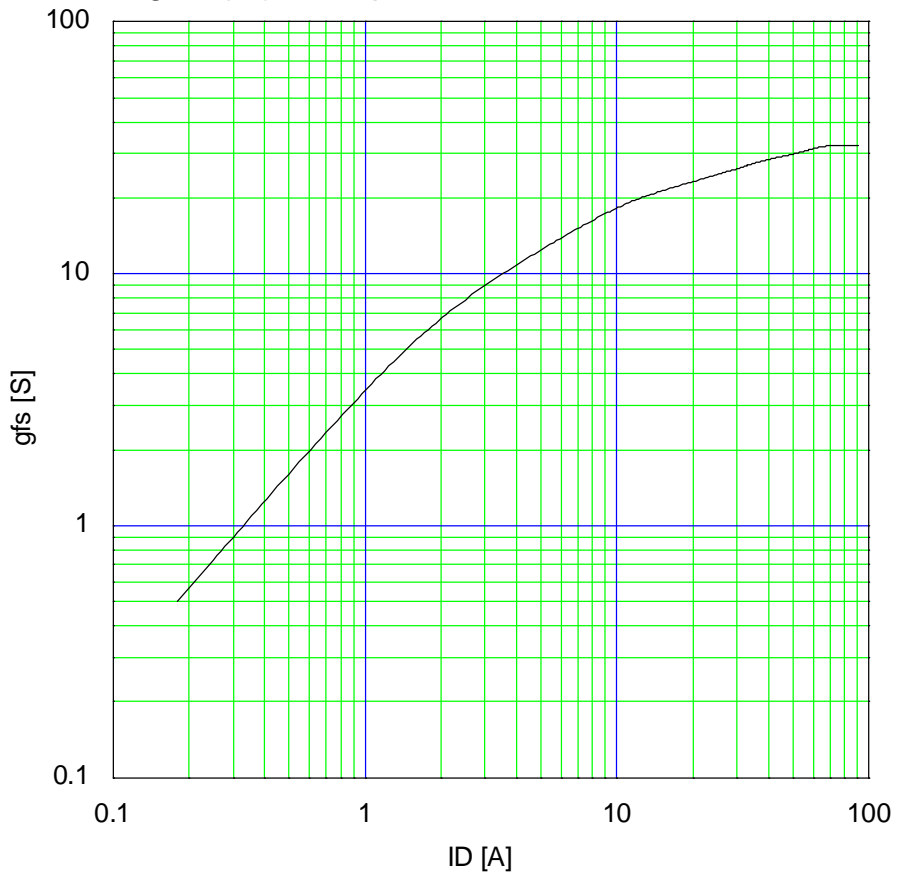

This material and the information herein is the property of Fuji Electric Device Technology Co., Ltd. They shall be neither reproduced, copied, lent, or disclosed in any way whatsoever for the use of any third party nor used for the manufacturing purposes without the express written consent of Fuji Electric Device Technology Co., Ltd.

Typical Drain-Source on-state Resistance  
 $R_{DS(on)}=f(I_D):80 \mu s$  pulse test,  $T_{ch}=25 \text{ }^\circ\text{C}$

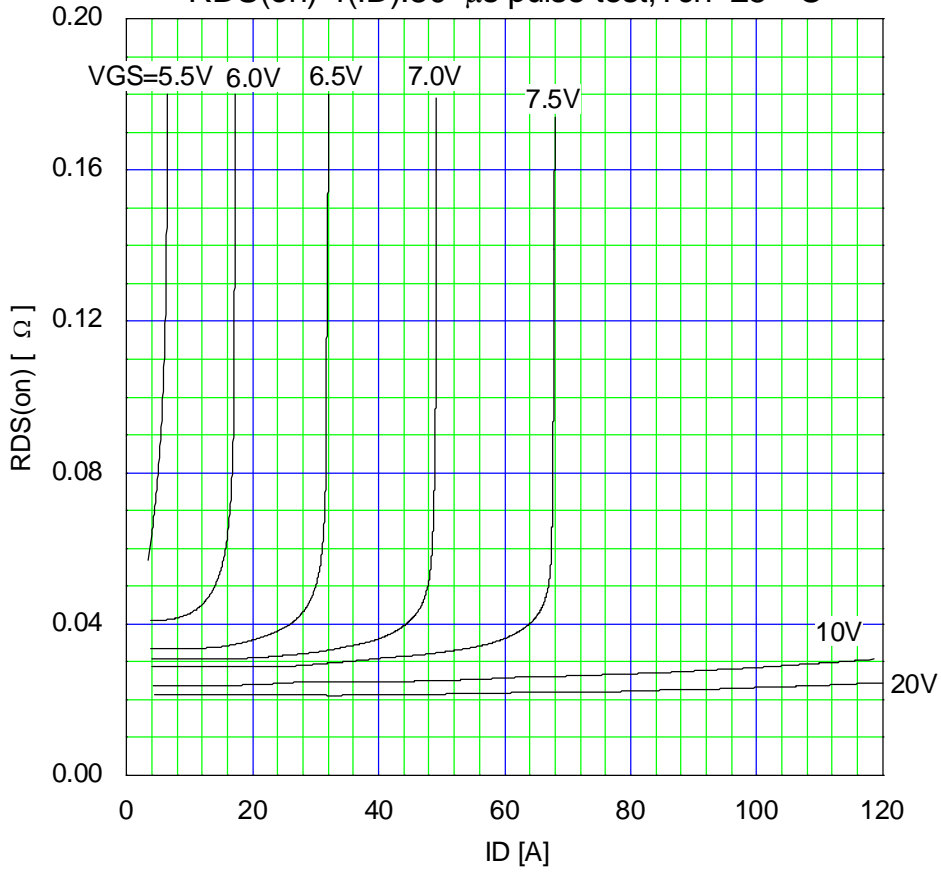

Drain-Source On-state Resistance  
 $R_{DS(on)}=f(T_{ch}):I_D=33.5A, V_{GS}=10V$

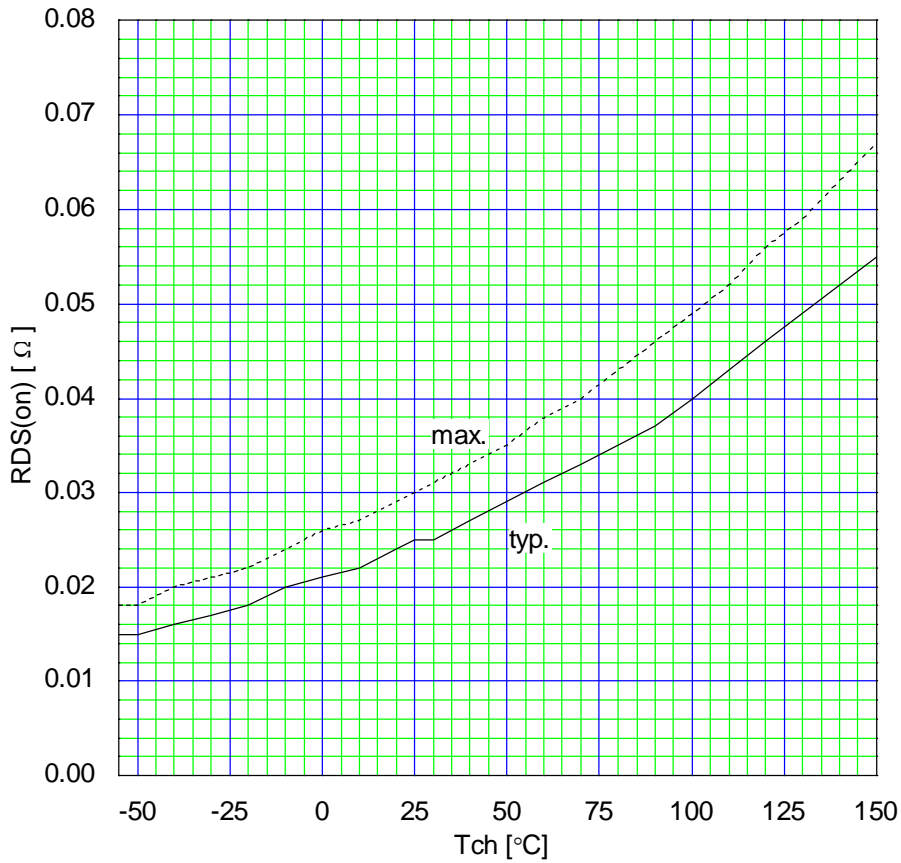

This material and the information herein is the property of Fuji Electric Device Technology Co., Ltd. They shall be neither reproduced, copied, lent, or disclosed in any way whatsoever for the use of any third party nor used for the manufacturing purposes without the express written consent of Fuji Electric Device Technology Co., Ltd.

Gate Threshold Voltage vs. T<sub>ch</sub>  
 $V_{GS(th)} = f(T_{ch}) : V_{DS} = V_{GS}, I_D = 250\mu A$

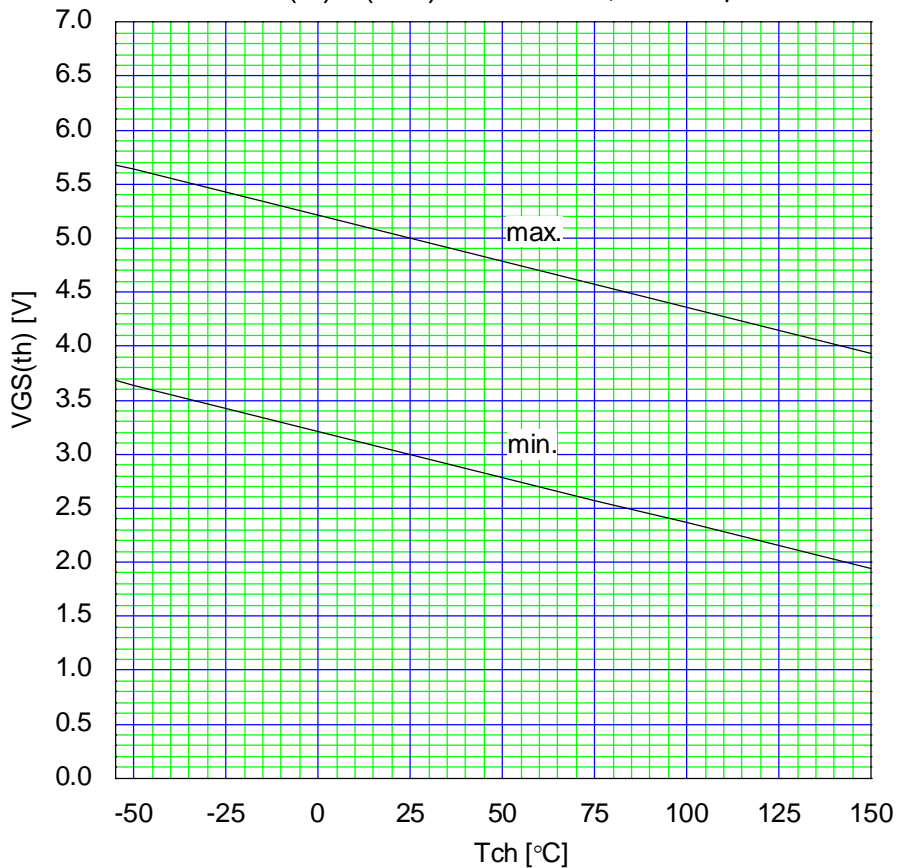

Typical Gate Charge Characteristics  
 $V_{GS} = f(Q_g) : I_D = 67A, T_{ch} = 25\text{ °C}$

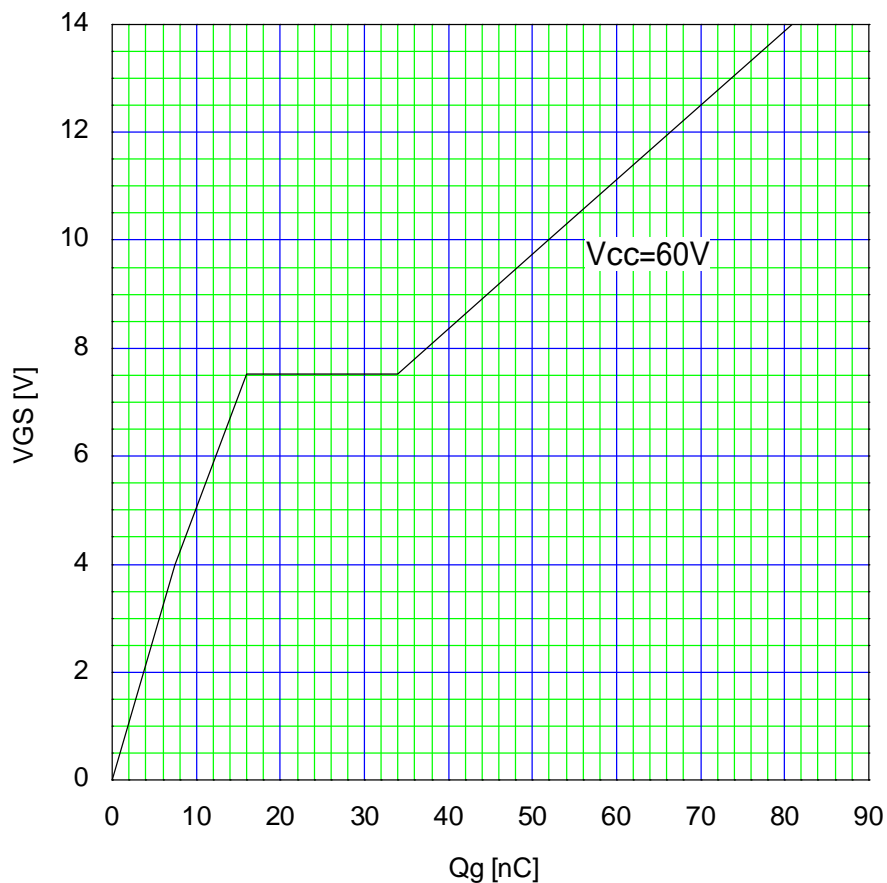

Typical Capacitance  
 $C=f(V_{DS}):V_{GS}=0V, f=1MHz$

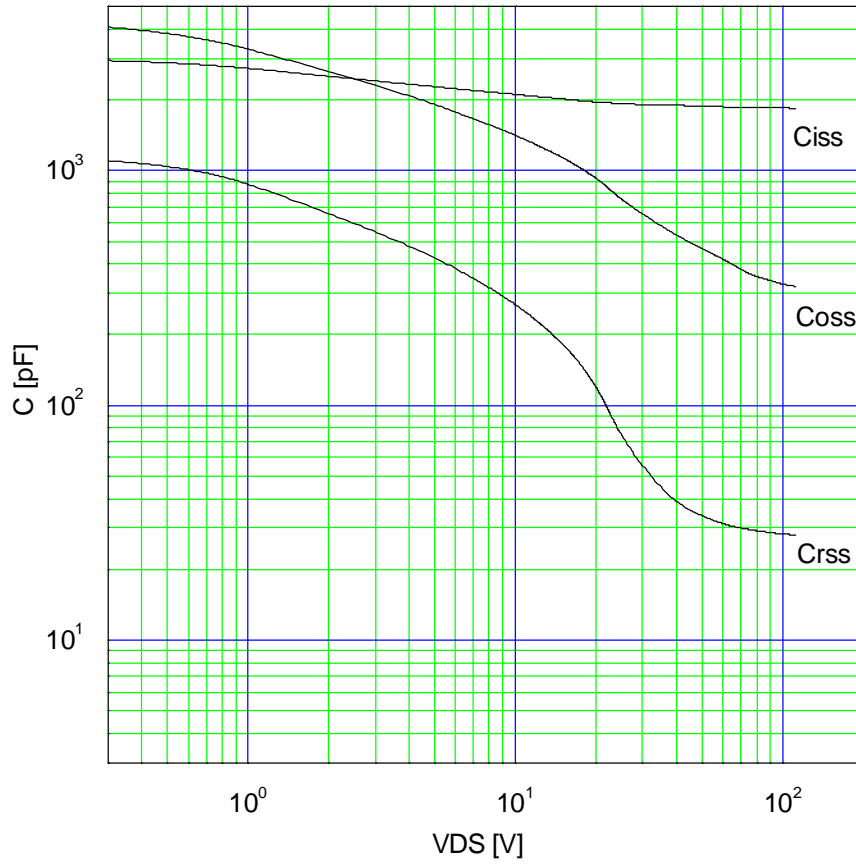

Typical Forward Characteristics of Reverse Diode  
 $I_F=f(V_{SD}):80\mu s\text{ pulse test}, T_{ch}=25\text{ }^\circ C$

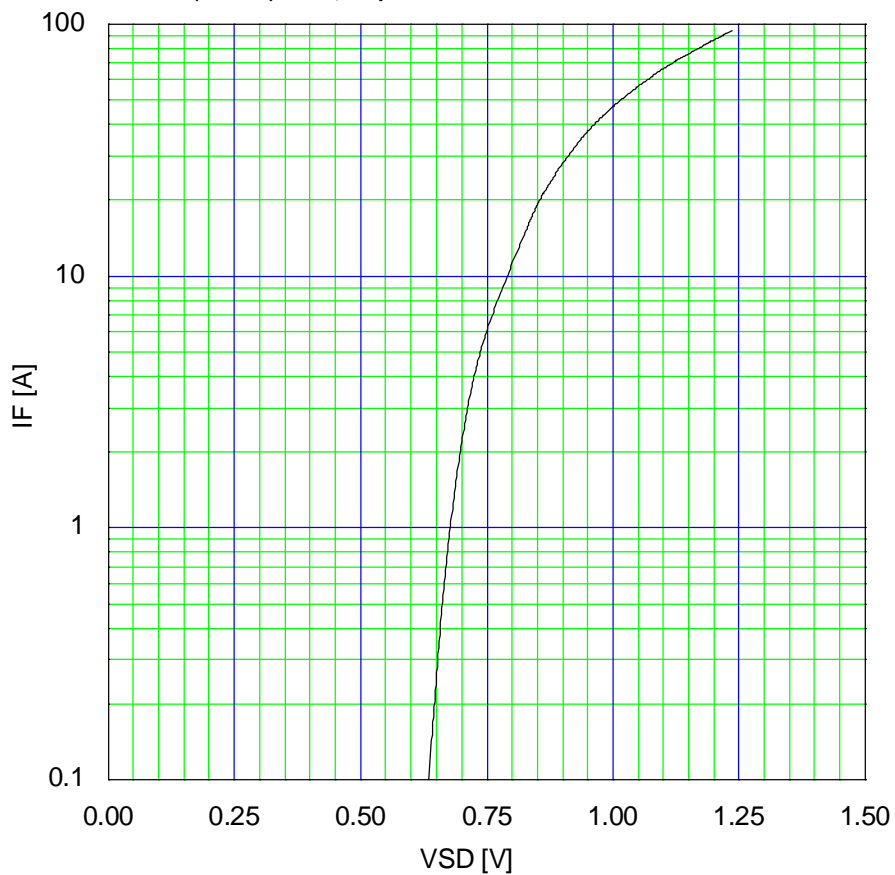

This material and the information herein is the property of Fuji Electric Device Technology Co., Ltd. They shall be neither reproduced, copied, lent, or disclosed in any way whatsoever for the use of any third party nor used for the manufacturing purposes without the express written consent of Fuji Electric Device Technology Co., Ltd.



This material and the information herein is the property of Fuji Electric Device Technology Co., Ltd. They shall be neither reproduced, copied, lent, or disclosed in any way whatsoever for the use of any third party nor used for the manufacturing purposes without the express written consent of Fuji Electric Device Technology Co., Ltd.

Typical Switching Characteristics vs. ID  
 $t=f(I_D): V_{CC}=48V, V_{GS}=10V, R_G=10 \Omega$

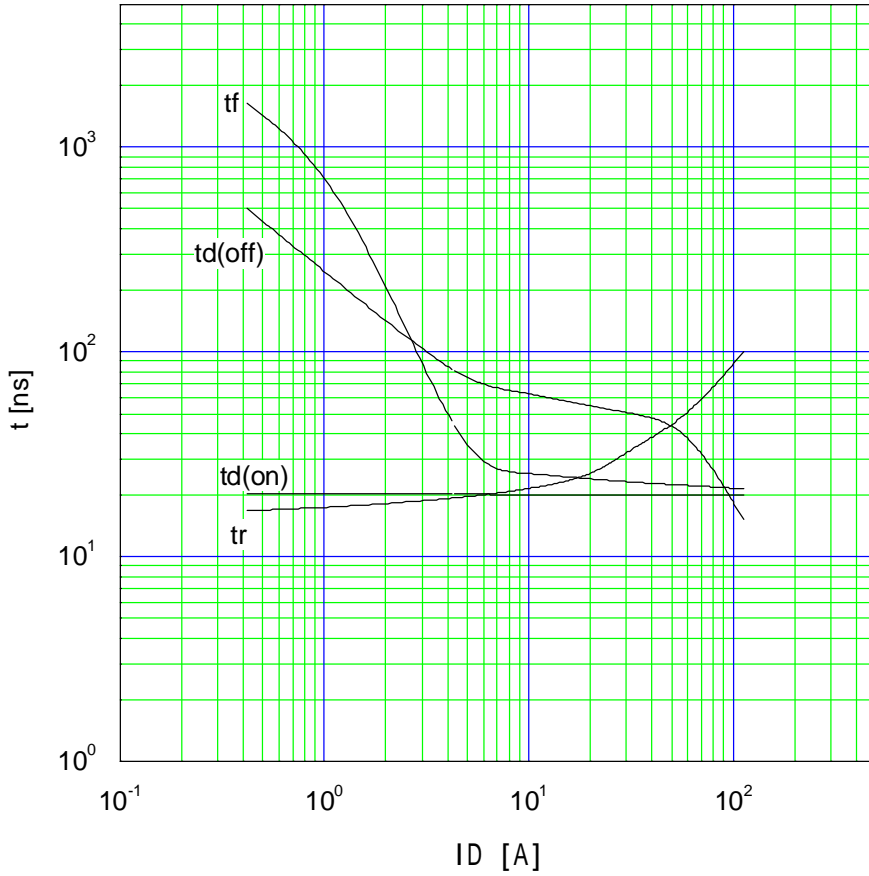

Maximum Avalanche Energy vs. starting Tch  
 $E(AV)=f(\text{starting } Tch): V_{CC}=48V, I(AV) \leq 67A$

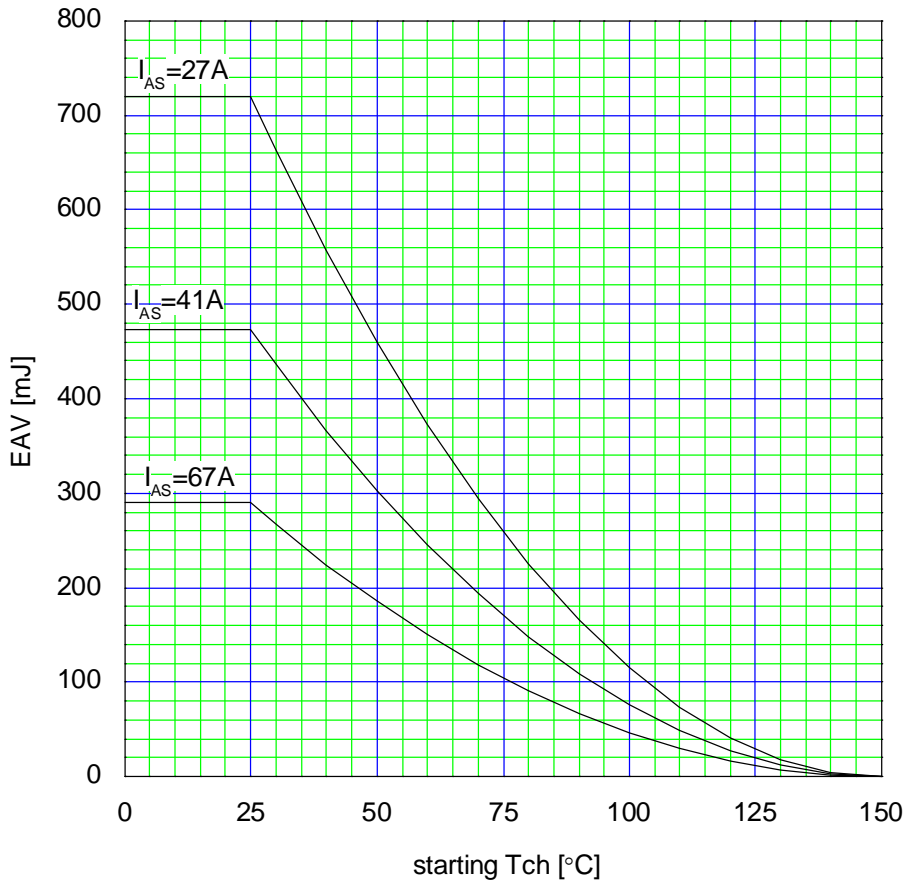

This material and the information herein is the property of Fuji Electric Device Technology Co., Ltd. They shall be neither reproduced, copied, lent, or disclosed in any way whatsoever for the use of any third party nor used for the manufacturing purposes without the express written consent of Fuji Electric Device Technology Co., Ltd.

### Maximum Avalanche Current Pulsewidth

$$I_{AV} = f(t_{AV}): \text{starting } T_{ch} = 25^{\circ}\text{C}, V_{CC} = 48\text{V}$$

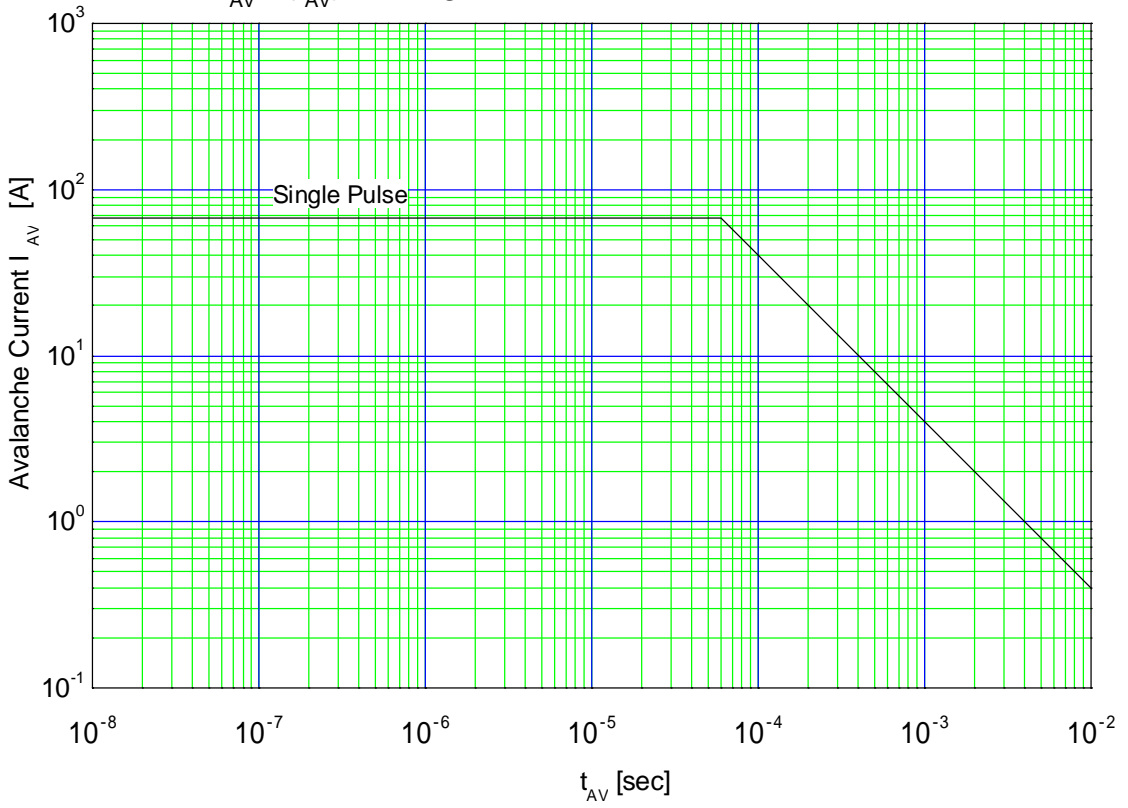

### Maximum Transient Thermal Impedance

$$Z_{th}(ch-c) = f(t): D=0$$

