

Super FAP-G Series

N-CHANNEL SILICON POWER MOSFET

Features

- High speed switching
- No secondary breakdown
- Avalanche-proof
- Low on-resistance
- Low driving power

Applications

- Switching regulators
- UPS (Uninterruptible Power Supply)
- DC-DC converters

Maximum ratings and characteristic Absolute maximum ratings (Tc=25°C unless otherwise specified)

Item	Symbol	Ratings	Unit	Remarks
Drain-source voltage	V _{DS}	600	V	
	V _{DSX}	600	V	V _{GS} =-30V
Continuous drain current	I _D	3.0	A	
Pulsed drain current	I _{D(puls)}	±12.0	A	
Gate-source voltage	V _{GS}	±30	V	
Repetitive or non-repetitive	I _{AR}	3.0	A	Note *1
Non-repetitive Maximum avalanche energy	E _{AS}	237.3	mJ	Note *2
Repetitive Maximum avalanche energy	E _{AR}	6.0	mJ	Note *3
Maximum drain-source dV/dt	dV _{DS} /dt	20	kV/μs	V _{DS} ≤ 600V
Peak diode recovery dV/dt	dV/dt	5	kV/μs	Note *4
Maximum power dissipation	P _D	60	W	T _c =25°C
		2.02	W	T _a =25°C
Operating and storage temperature range	T _{ch} T _{stg}	+150 -55 to +150	°C	

Note *1 T_{ch} ≤ 150°C

Note *2 Starting T_{ch}=25°C, I_{AS}=1.2A, L=302mH, V_{CC}=60V, R_G=50Ω
E_{AS} limited by maximum channel temperature and avalanche current.
See to 'Avalanche Energy' graph.

Note *3 Repetitive rating : Pulse width limited by maximum channel temperature.
See to 'Transient Thermal impedance' graph.

Note *4 I_F ≤ -I_D, -di/dt=50A/μs, V_{CC} ≤ BV_{DSS}, T_{ch} ≤ 150°C

Outline Drawings [mm]

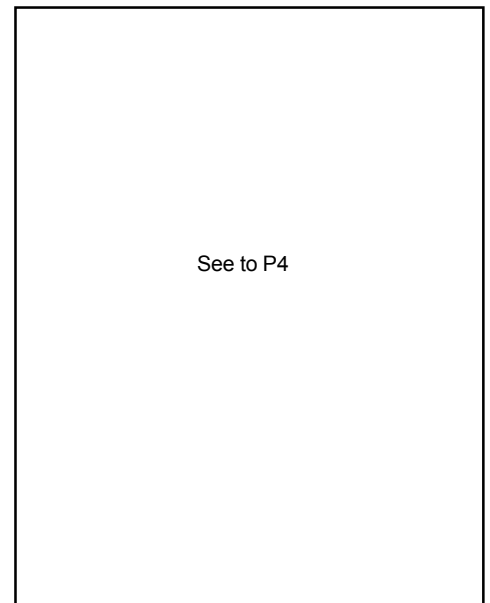

Equivalent circuit schematic

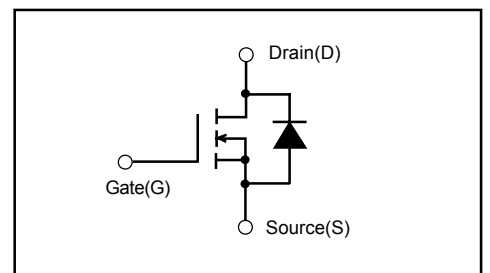

Electrical characteristics (T_c =25°C unless otherwise specified)

Item	Symbol	Test Conditions	Min.	Typ.	Max.	Units
Drain-source breakdown voltage	BV _{DSS}	I _D = 250μA V _{GS} =0V	600			V
Gate threshold voltage	V _{GS(th)}	I _D = 250μA V _{DS} =V _{GS}	3.0		5.0	V
Zero gate voltage drain current	I _{DSS}	V _{DS} =600V V _{GS} =0V T _{ch} =25°C			25	μA
		V _{DS} =480V V _{GS} =0V T _{ch} =125°C			250	
Gate-source leakage current	I _{GSS}	V _{GS} =±30V V _{DS} =0V			100	nA
Drain-source on-state resistance	R _{DS(on)}	I _D =1.5A V _{GS} =10V		2.64	3.3	Ω
Forward transconductance	g _{fs}	I _D =1.5A V _{DS} =25V	1.5	3.0		S
Input capacitance	C _{iss}	V _{DS} =25V		330	500	pF
Output capacitance	C _{oss}	V _{GS} =0V		50	75	
Reverse transfer capacitance	C _{rss}	f=1MHz		2.5	5.0	
Turn-on time t _{on}	t _{d(on)}	V _{CC} =300V I _D =1.5A		11	18	ns
	t _r	V _{GS} =10V		5.0	7.5	
Turn-off time t _{off}	t _{d(off)}	R _{GS} =10 Ω		23	35	
	t _r			10	15	
Total Gate Charge	Q _G	V _{CC} =250V		13	20	nC
Gate-Source Charge	Q _{GS}	I _D =3.0A		5.5	8.5	
Gate-Drain Charge	Q _{GD}	V _{GS} =10V		2.8	4.2	
Diode forward on-voltage	V _{SD}	I _F =3.0A V _{GS} =0V T _{ch} =25°C		1.00	1.50	V
Reverse recovery time	t _{rr}	I _F =3.0A V _{GS} =0V		0.5		μs
Reverse recovery charge	Q _{rr}	-di/dt=100A/μs T _{ch} =25°C		2.3		μC

Thermal characteristics

Item	Symbol	Test Conditions	Min.	Typ.	Max.	Units
Thermal resistance	R _{th(ch-c)}	channel to case			2.083	°C/W
	R _{th(ch-a)}	channel to ambient			62.0	°C/W

Characteristics

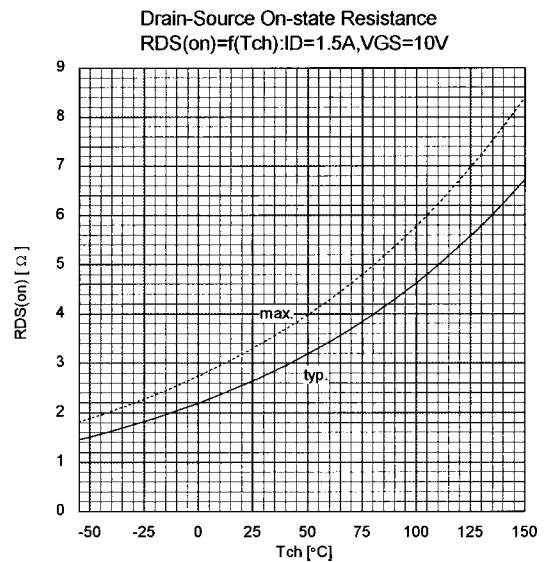
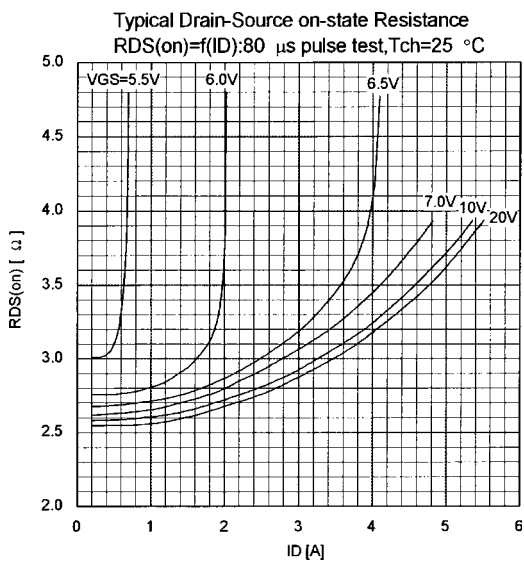
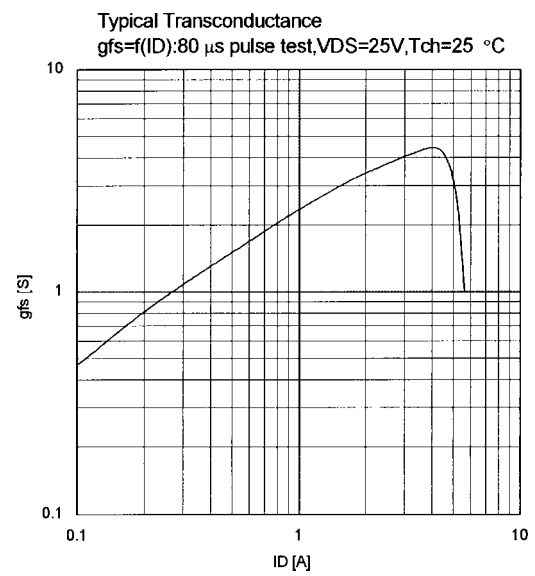
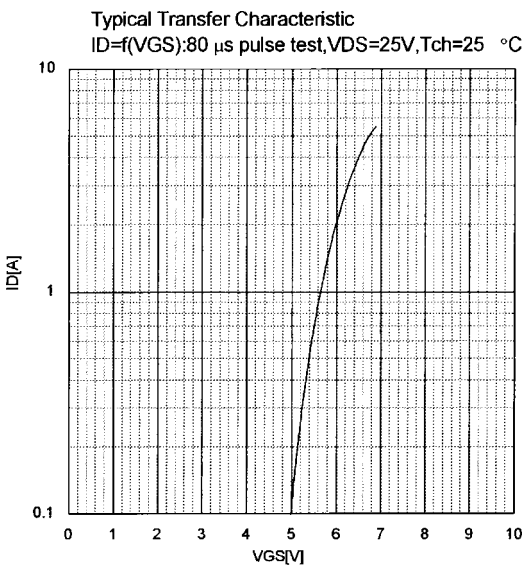
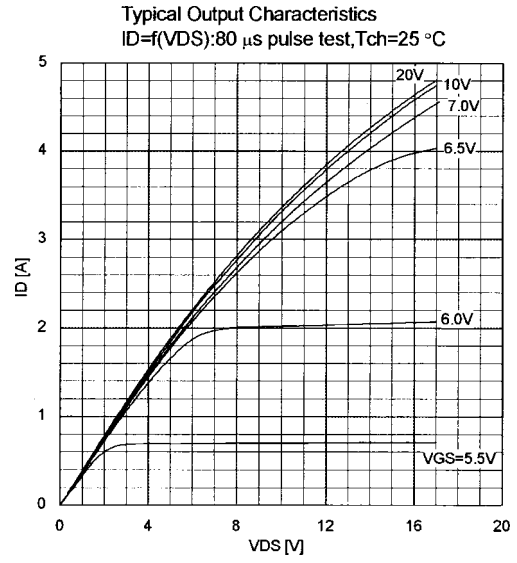
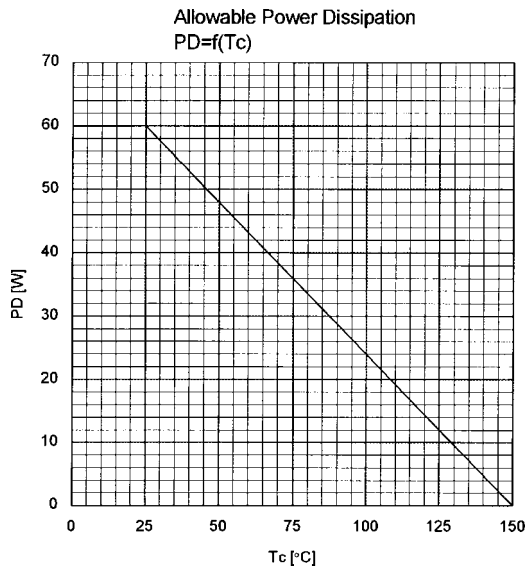

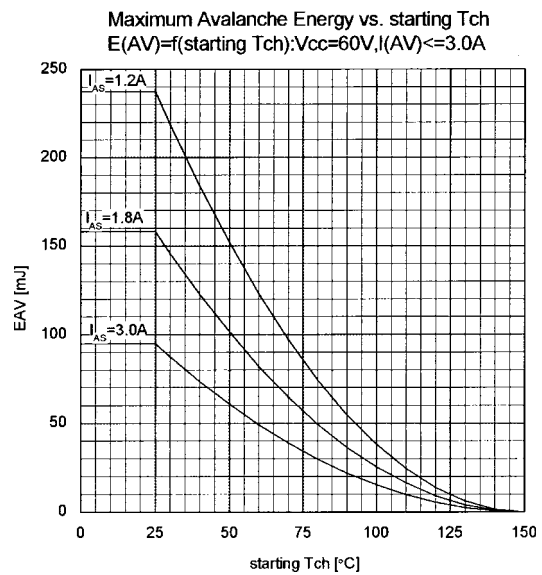
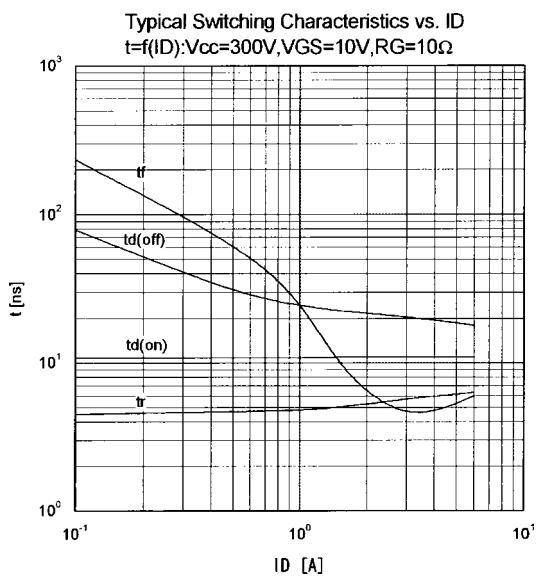
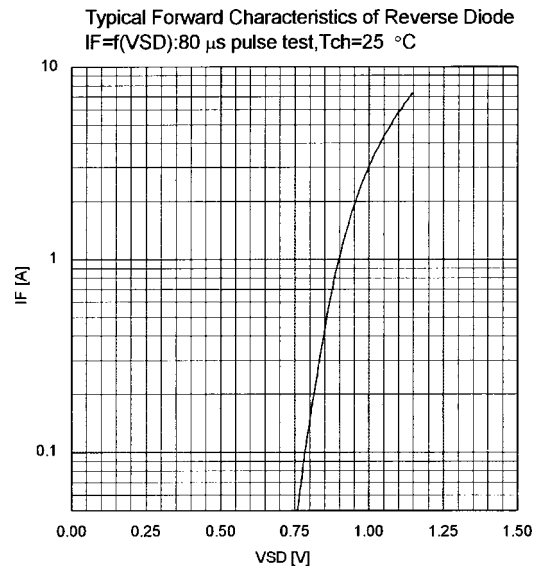
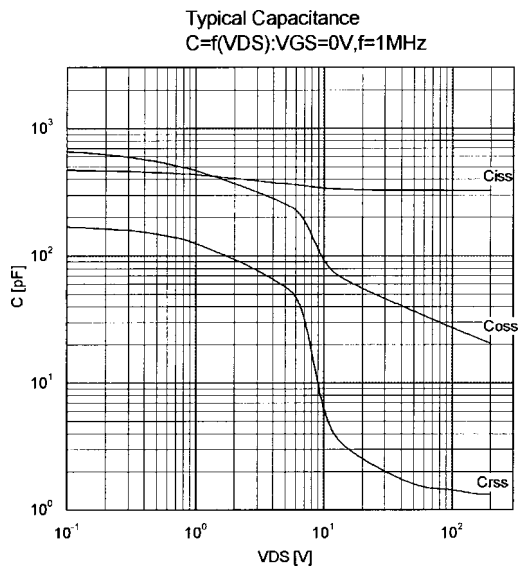
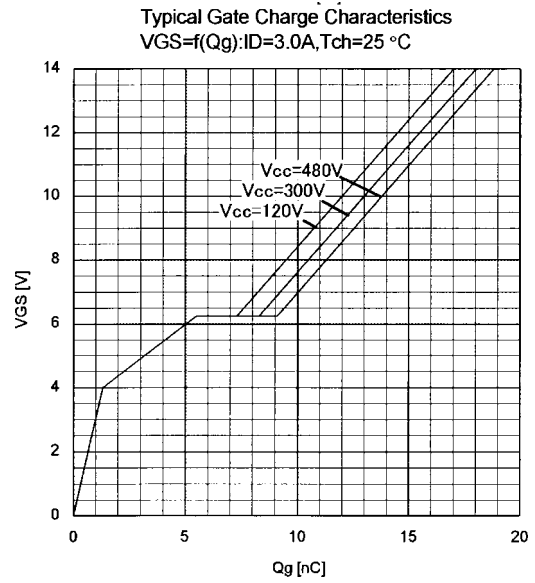
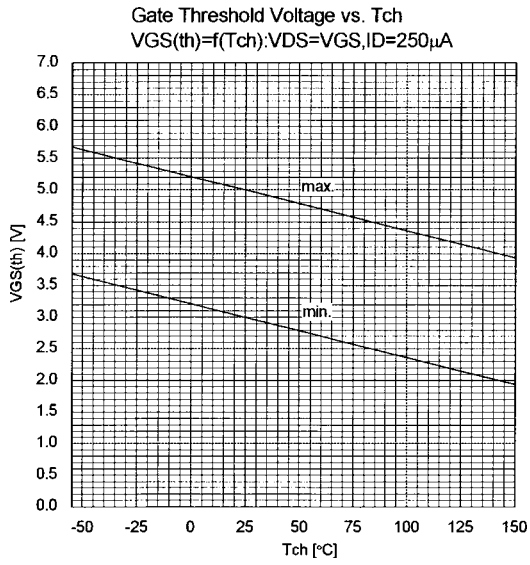

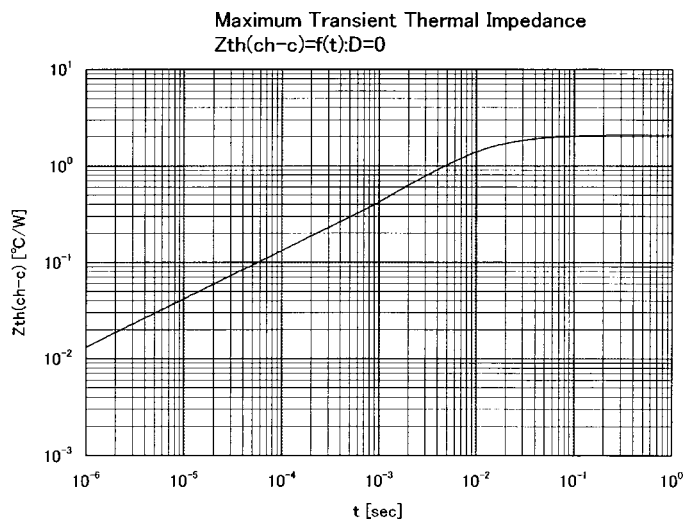
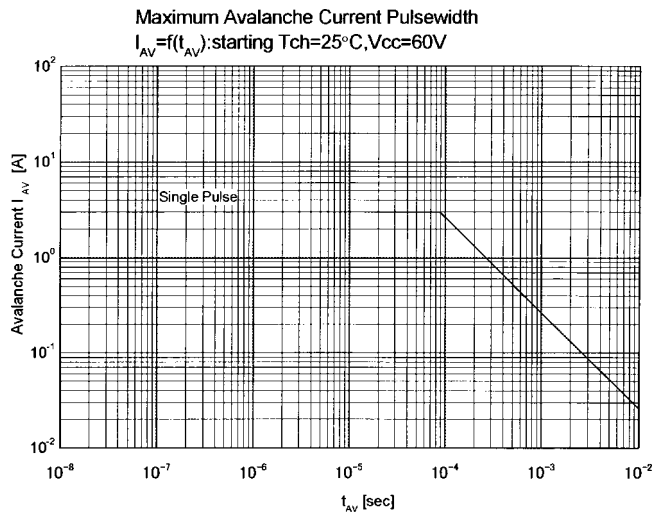

Outline Drawings [mm]

T-pack(L)

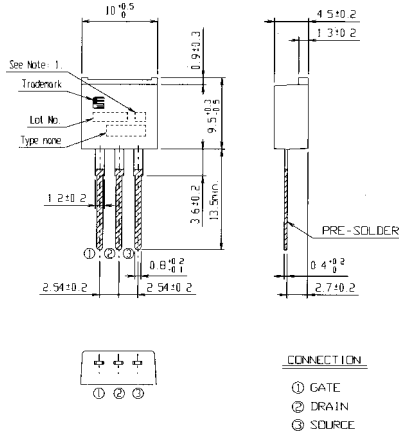

Note: 1 Guaranteed mark of avalanche ruggedness.

T-pack(S)

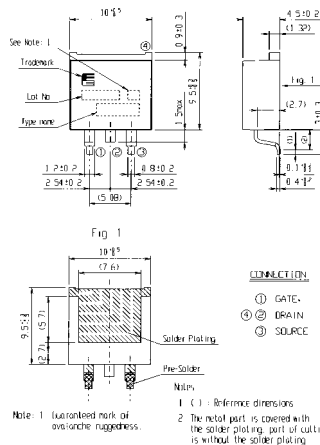

T-pack(SJ) [D2-pack]

