

### 600V / 10A 6 in one-package

#### ■ Features

- Compact Single in -line package

#### ■ Applications

- Inverter for Motor drive
- AC and DC Servo drive amplifier
- Uninterruptible power supply
- Industrial machines, such as Welding machines



#### ■ Maximum ratings and characteristics

##### ● Absolute maximum ratings (at Tc=25°C unless otherwise specified)

Item	Symbol	Rating	Unit
Collector-Emitter voltage	V <sub>CES</sub>	600	V
Gate-Emitter voltage	V <sub>GES</sub>	±20	V
Collector current	Continuous	I <sub>C</sub>	10 A
	1ms	I <sub>C</sub> pulse	20 A
		-I <sub>C</sub>	10 A
	1ms	-I <sub>C</sub> pulse	20 A
Max. power dissipation	P <sub>C</sub>	45	W
Operating temperature	T <sub>j</sub>	+150	°C
Storage temperature	T <sub>stg</sub>	-40 to +125	°C
Isolation voltage	V <sub>is</sub>	AC 2000 (1min.)	V
Screw torque	Mounting *1	1.7	N·m

\*1 : Recommendable value : 1.3 to 1.7 N·m (M4)

#### ■ Equivalent Circuit Schematic

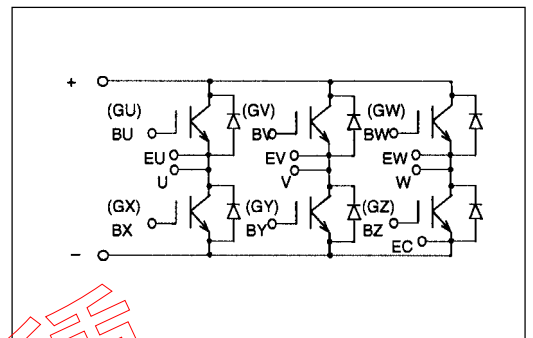

##### ● Electrical characteristics (at Tj=25°C unless otherwise specified)

Item	Symbol	Characteristics			Conditions	Unit
		Min.	Typ.	Max.		
Zero gate voltage collector current	I <sub>CES</sub>	-	-	1.0	V <sub>GE</sub> =0V, V <sub>CES</sub> =600V	mA
Gate-Emitter leakage current	I <sub>GES</sub>	-	-	0.1	V <sub>CE</sub> =0V, V <sub>GE</sub> =±20V	μA
Gate-Emitter threshold voltage	V <sub>GE(th)</sub>	5.5	-	8.5	V <sub>CE</sub> =20V, I <sub>C</sub> =10mA	V
Collector-Emitter saturation voltage	V <sub>CE(sat)</sub>	-	-	2.8	V <sub>GE</sub> =15V, I <sub>C</sub> =10A	V
Input capacitance	C <sub>ies</sub>	-	650	-	V <sub>GE</sub> =0V	pF
Output capacitance	C <sub>oes</sub>	-	150	-	V <sub>CE</sub> =10V	
Reverse transfer capacitance	C <sub>res</sub>	-	36	-	f=1MHz	
Turn-on time	t <sub>on</sub>	-	-	1.2	V <sub>CC</sub> =300V	μs
	t <sub>r</sub>	-	-	1.0	I <sub>C</sub> =10A	
Turn-off time	t <sub>off</sub>	-	-	1.0	V <sub>GE</sub> =±15V	
	t <sub>f</sub>	-	-	0.35	R <sub>G</sub> =220ohm	
Diode forward on voltage	V <sub>F</sub>	-	-	3.0	I <sub>F</sub> =10A, V <sub>GE</sub> =0V	V
Reverse recovery time	t <sub>rr</sub>	-	-	0.3	I <sub>F</sub> =10A, -di/dt=30A/μs, V <sub>GE</sub> =-10V	μs

##### ● Thermal resistance characteristics

Item	Symbol	Characteristics			Conditions	Unit
		Min.	Typ.	Max.		
Thermal resistance	R <sub>th(j-c)</sub>	-	-	2.78	IGBT	°C/W
	R <sub>th(j-c)</sub>	-	-	4.5	Diode	°C/W
	R <sub>th(c-f)*2</sub>	-	0.06	-	the base to cooling fin	°C/W

\*2 : This is the value which is defined mounting on the additional cooling fin with thermal compound

■ Characteristics (Representative)

Collector current vs. Collector-Emitter voltage  
T<sub>J</sub>=25°C

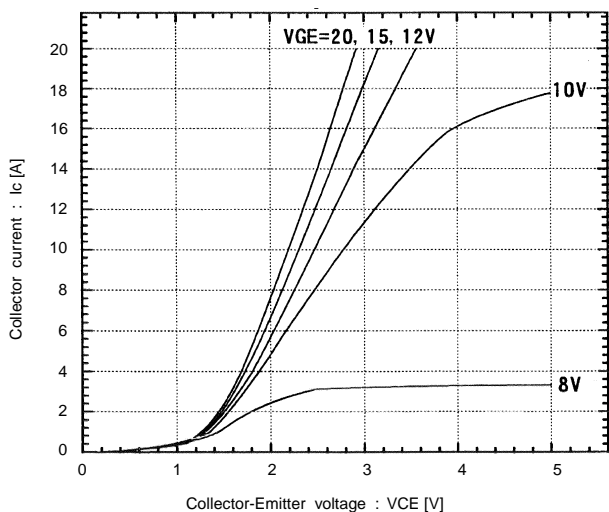

Collector current vs. Collector-Emitter voltage  
T<sub>J</sub>=125°C

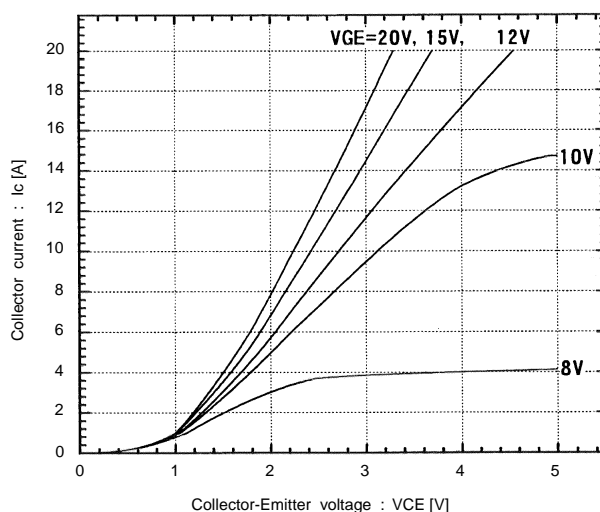

Collector-Emitter vs. Gate-Emitter voltage  
T<sub>J</sub>=25°C

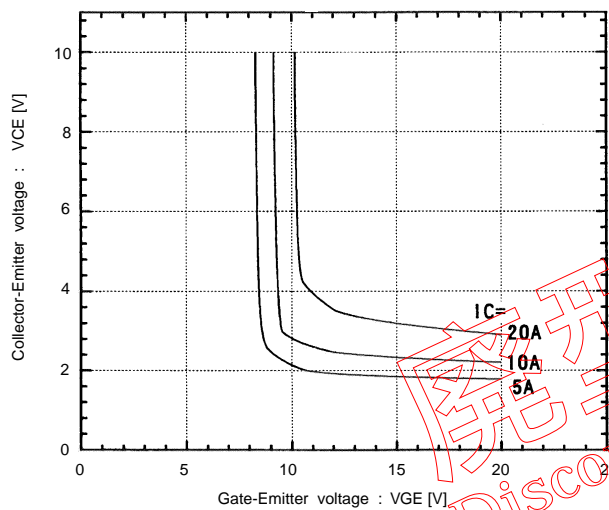

Collector-Emitter vs. Gate-Emitter voltage  
T<sub>J</sub>=125°C

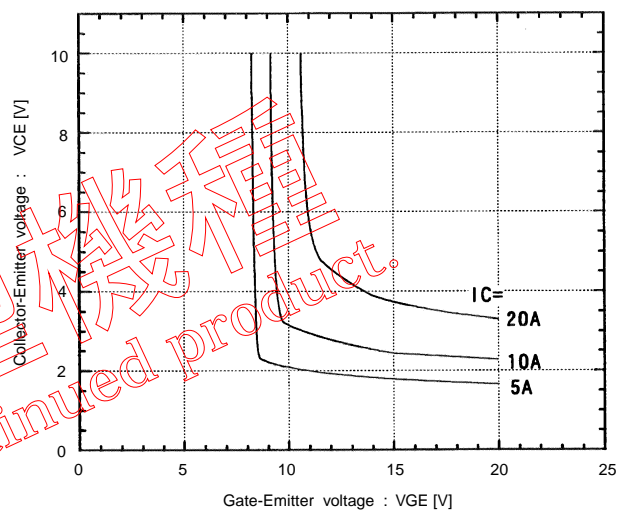

Switching time vs. Collector current  
V<sub>CC</sub>=300V, R<sub>G</sub>=220 ohm, V<sub>GE</sub>=±15V, T<sub>J</sub>=25°C

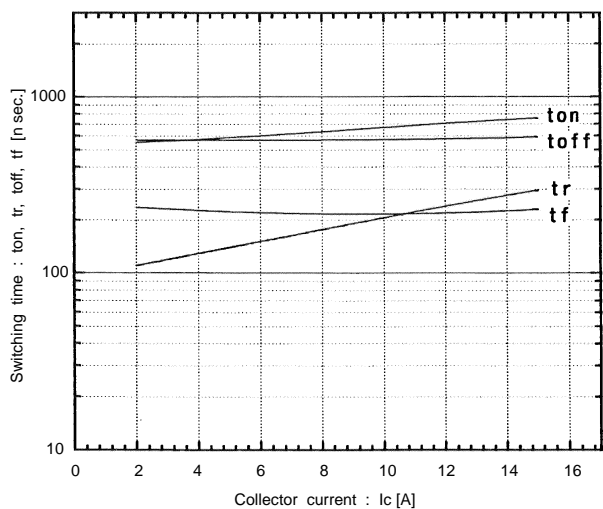

Switching time vs. Collector current  
V<sub>CC</sub>=300V, R<sub>G</sub>=220 ohm, V<sub>GE</sub>=±15V, T<sub>J</sub>=125°C

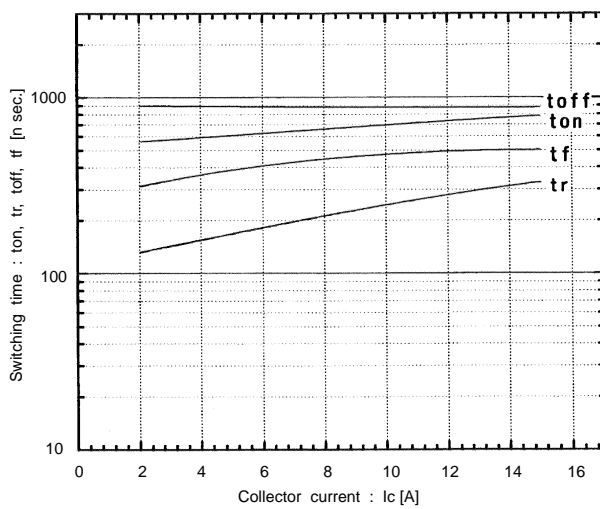

廃型機種  
 Discontinued product.

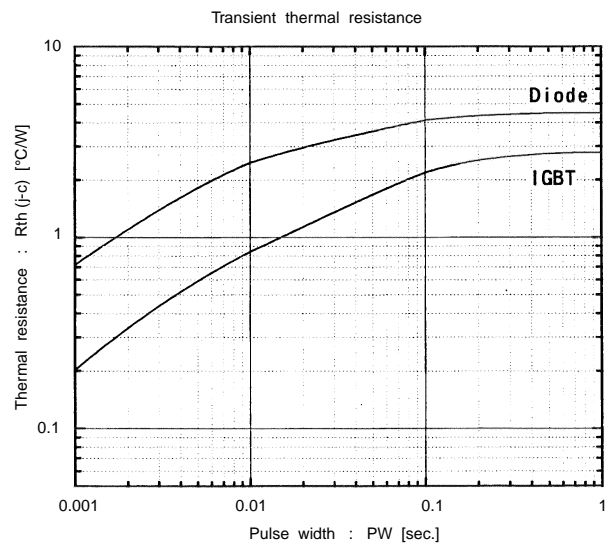
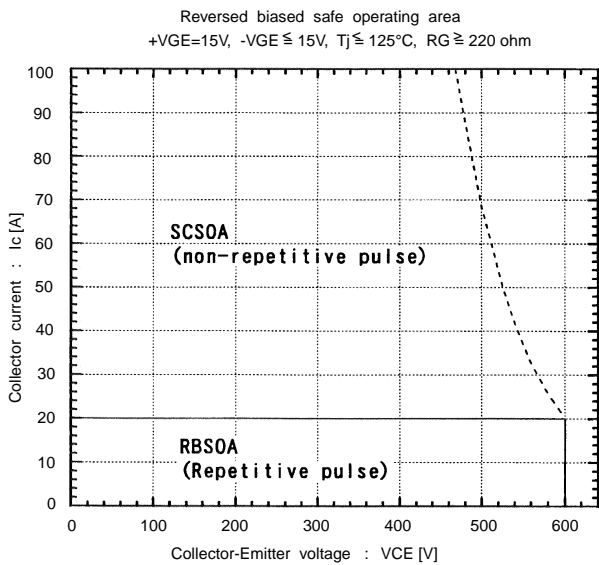
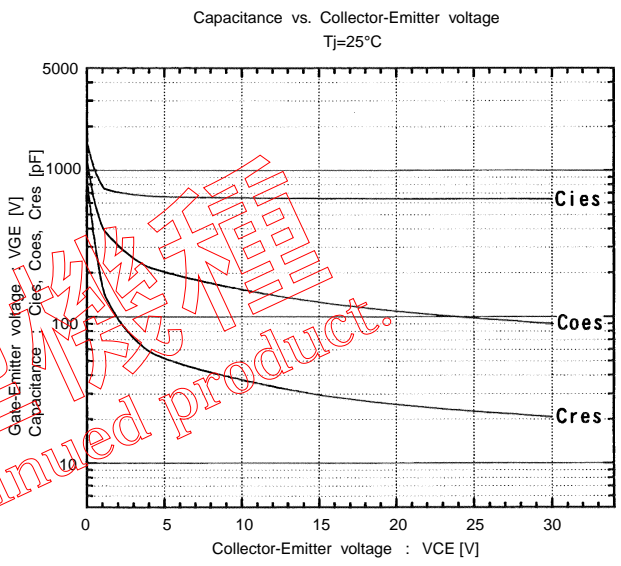
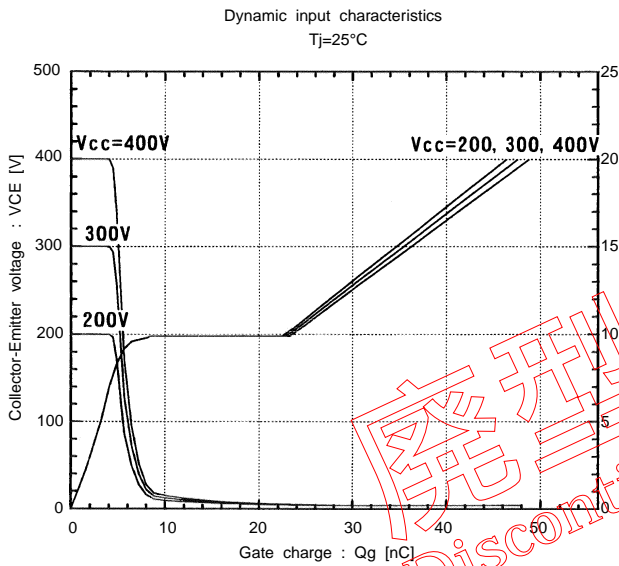
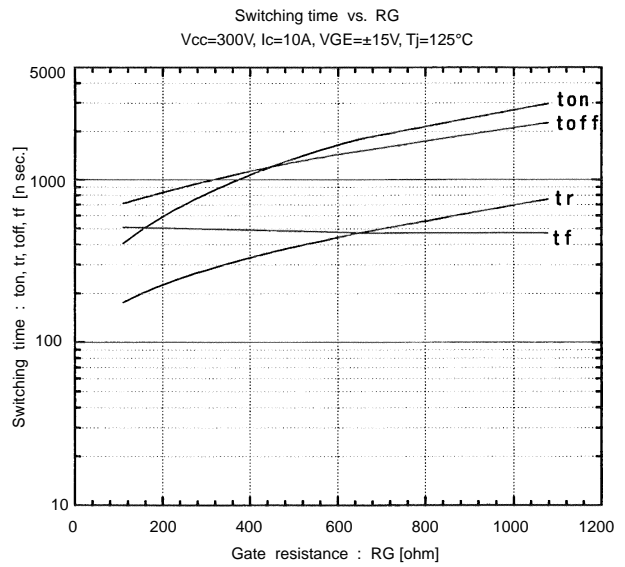
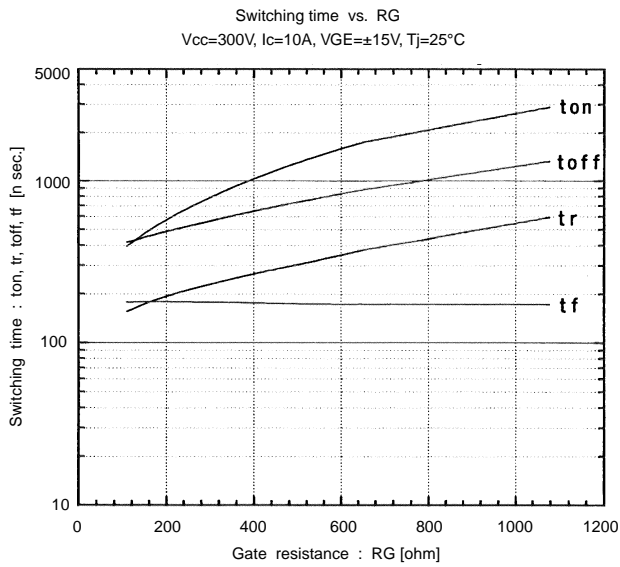

Switching loss vs. Collector current  
 $V_{cc}=300V, R_G=220\ \text{ohm}, V_{GE}=\pm 15V, T_J=125^\circ\text{C}$

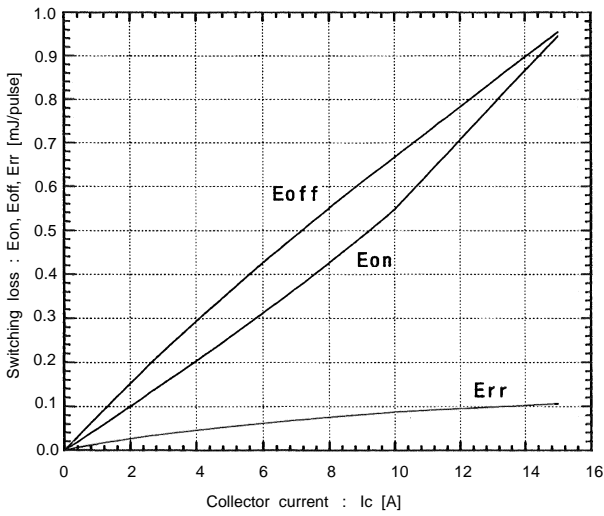

Switching loss vs. Gate resistance  
 $V_{cc}=300V, I_c=10A, V_{GE}=\pm 15V, T_J=125^\circ\text{C}$

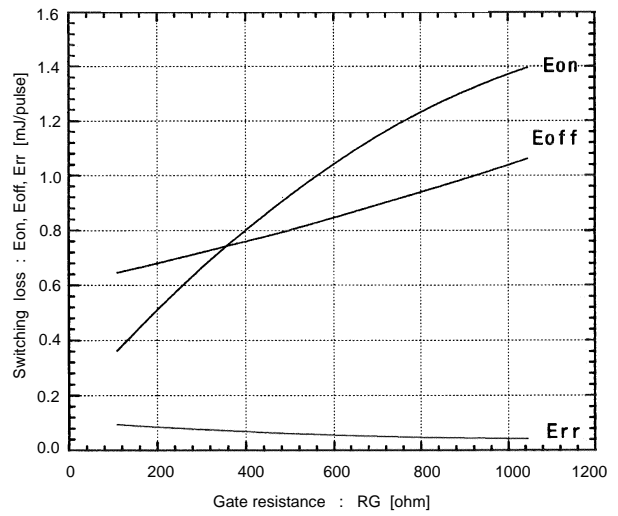

Forward current vs. Forward voltage

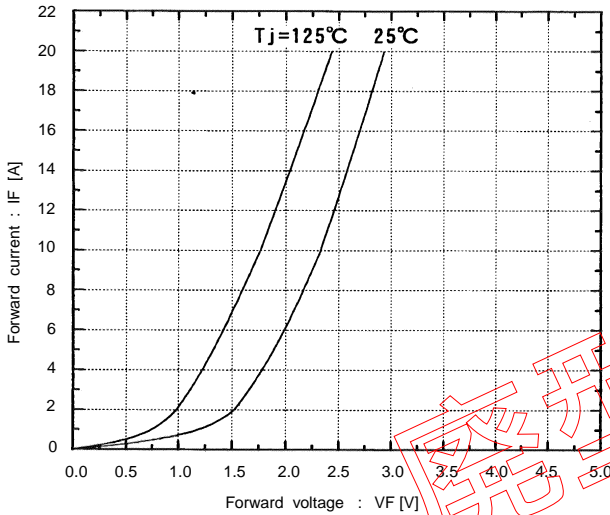

Reverse recovery characteristics  
 $t_{rr}, I_{rr}$ , vs.  $I_F$

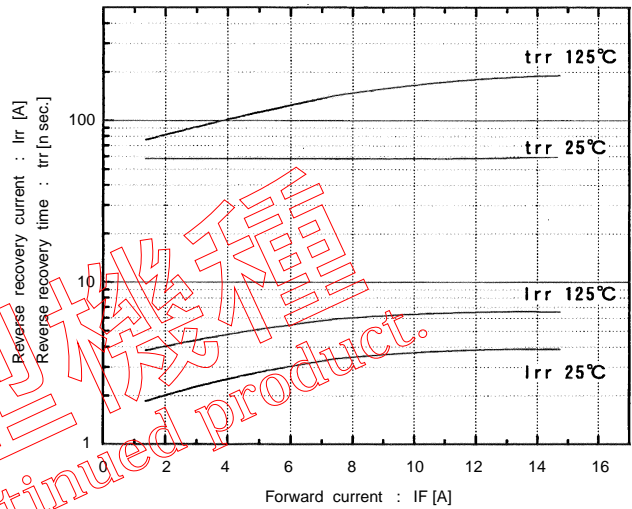

Outline Drawings, mm

