

600V / 15A 6 in one-package



■ Features

- Compact Single in -line package

■ Applications

- Inverter for Motor drive
- AC and DC Servo drive amplifier
- Uninterruptible power supply
- Industrial machines, such as Welding machines

■ Maximum ratings and characteristics

- Absolute maximum ratings (at $T_c=25^\circ\text{C}$ unless otherwise specified)

Item	Symbol	Rating	Unit
Collector-Emitter voltage	V_{CES}	600	V
Gate-Emitter voltage	V_{GES}	± 20	V
Collector current	Continuous	I_C	15 A
	1ms	I_C pulse	30 A
		$-I_C$	15 A
	1ms	$-I_C$ pulse	30 A
Max. power dissipation	P_C	60	W
Operating temperature	T_j	+150	$^\circ\text{C}$
Storage temperature	T_{stg}	-40 to +125	$^\circ\text{C}$
Isolation voltage	V_{is}	AC 2000 (1min.)	V
Screw torque	Mounting *1	1.7	N·m

*1 : Recommendable value : 1.3 to 1.7 N·m (M4)

■ Equivalent Circuit Schematic

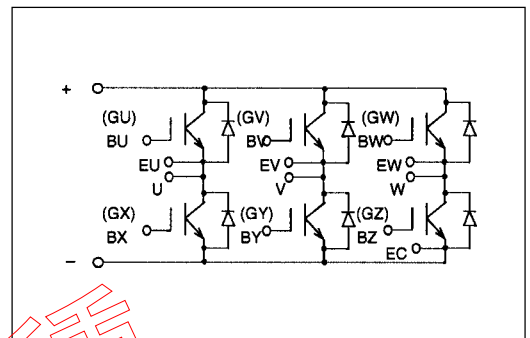

- Electrical characteristics (at $T_j=25^\circ\text{C}$ unless otherwise specified)

Item	Symbol	Characteristics			Conditions	Unit
		Min.	Typ.	Max.		
Zero gate voltage collector current	I_{CES}	–	–	1.0	$V_{GE}=0\text{V}$, $V_{CE}=600\text{V}$	mA
Gate-Emitter leakage current	I_{GES}	–	–	0.1	$V_{CE}=0\text{V}$, $V_{GE}=\pm 20\text{V}$	μA
Gate-Emitter threshold voltage	$V_{GE(th)}$	5.5	–	8.5	$V_{CE}=20\text{V}$, $I_C=15\text{mA}$	V
Collector-Emitter saturation voltage	$V_{CE(sat)}$	–	–	2.8	$V_{GE}=15\text{V}$, $I_C=15\text{A}$	V
Input capacitance	C_{ies}	–	975	–	$V_{GE}=0\text{V}$	pF
Output capacitance	C_{oes}	–	225	–	$V_{CE}=10\text{V}$	
Reverse transfer capacitance	C_{res}	–	54	–	$f=1\text{MHz}$	
Turn-on time	t_{on}	–	–	1.2	$V_{CC}=300\text{V}$	
Turn-off time	t_r	–	–	1.0	$I_C=15\text{A}$	μs
	t_{off}	–	–	1.0	$V_{GE}=\pm 15\text{V}$	
	t_f	–	–	0.35	$R_G=150\text{ohm}$	
Diode forward on voltage	V_F	–	–	3.0	$I_F=15\text{A}$, $V_{GE}=0\text{V}$	V
Reverse recovery time	t_{rr}	–	–	0.3	$I_F=15\text{A}$, $-di/dt=45\text{A}/\mu\text{s}$, $V_{GE}=-10\text{V}$	μs

● Thermal resistance characteristics

Item	Symbol	Characteristics			Conditions	Unit
		Min.	Typ.	Max.		
Thermal resistance	$R_{th(j-c)}$	–	–	2.08	IGBT	$^\circ\text{C}/\text{W}$
	$R_{th(j-c)}$	–	–	3.0	Diode	$^\circ\text{C}/\text{W}$
	$R_{th(c-f)*2}$	–	0.06	–	the base to cooling fin	$^\circ\text{C}/\text{W}$

*2 : This is the value which is defined mounting on the additional cooling fin with thermal compound

Characteristics (Representative)

Collector current vs. Collector-Emitter voltage
T_J=25°C

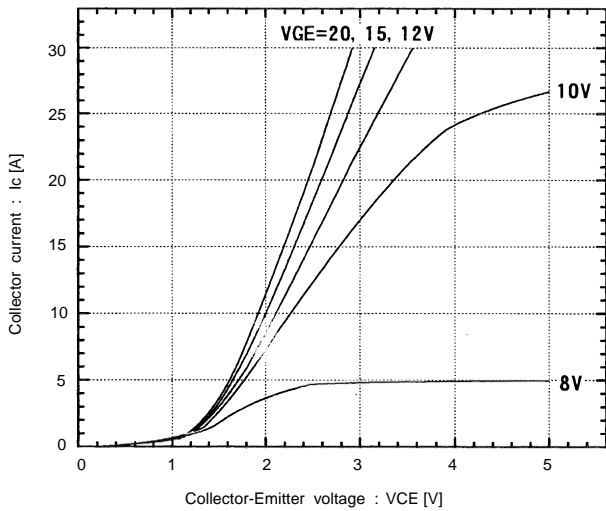

Collector current vs. Collector-Emitter voltage
T_J=125°C

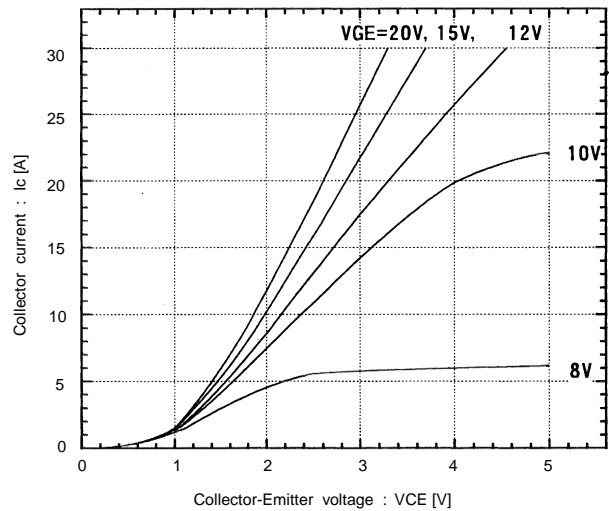

Collector-Emitter vs. Gate-Emitter voltage
T_J=25°C

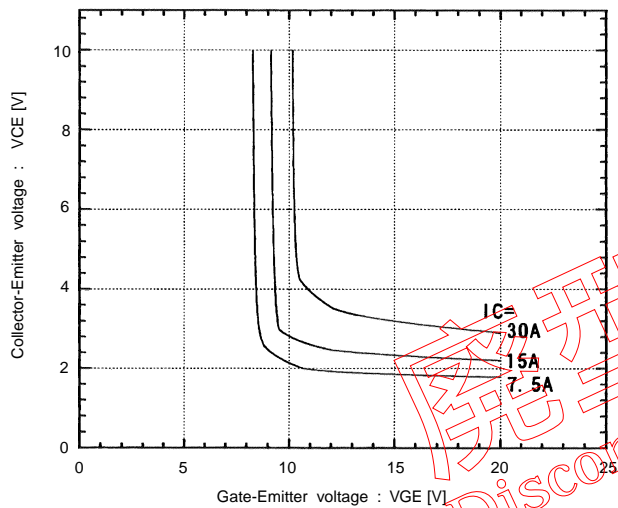

Collector-Emitter vs. Gate-Emitter voltage
T_J=125°C

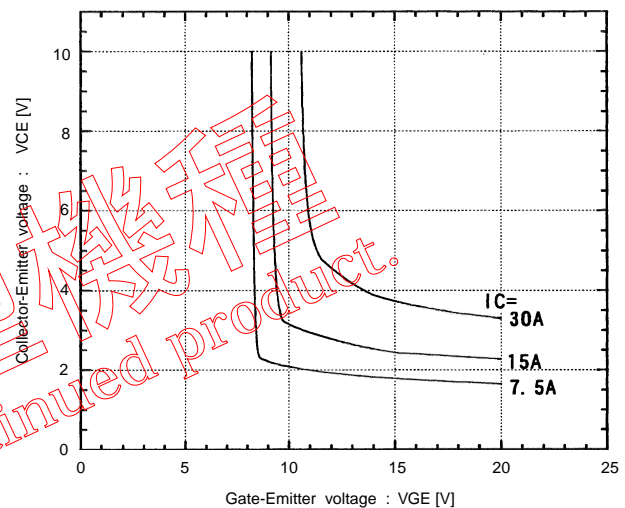

Switching time vs. Collector current
V_{CC}=300V, R_G=150 ohm, V_{GE}=±15V, T_J=25°C

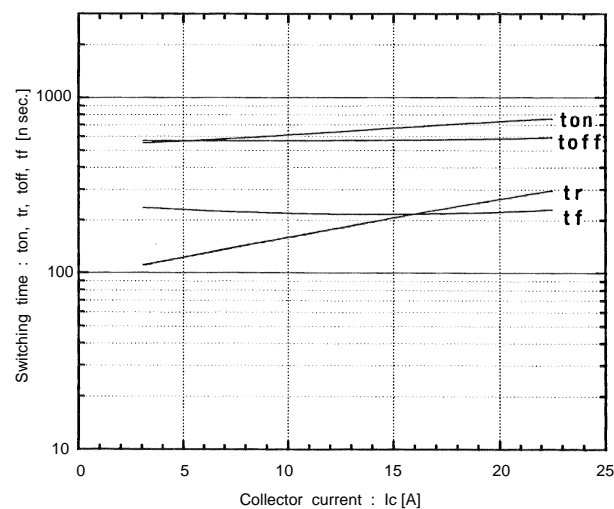

Switching time vs. Collector current
V_{CC}=300V, R_G=150 ohm, V_{GE}=±15V, T_J=125°C

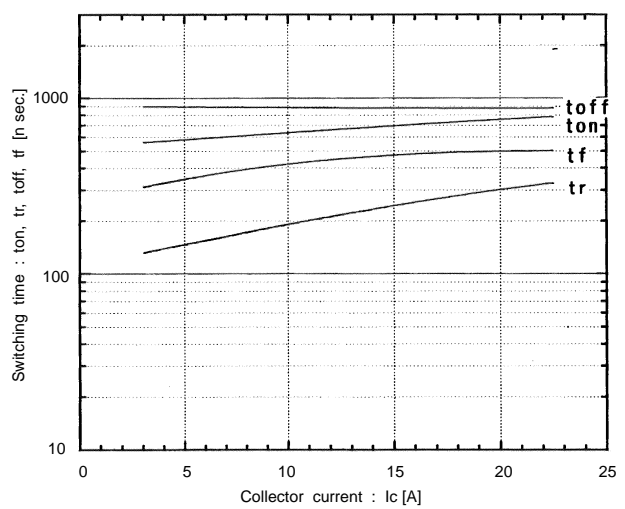

廣利機電
 Discontinued product

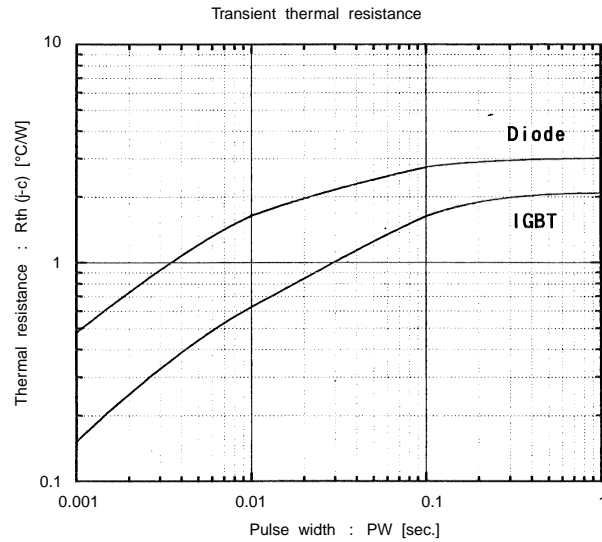
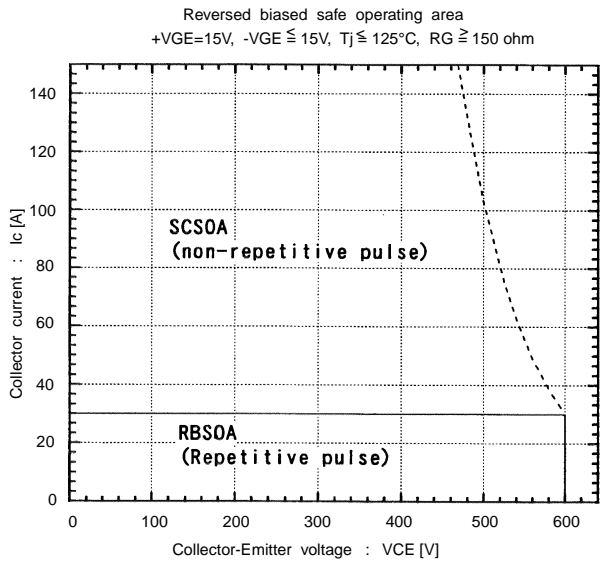
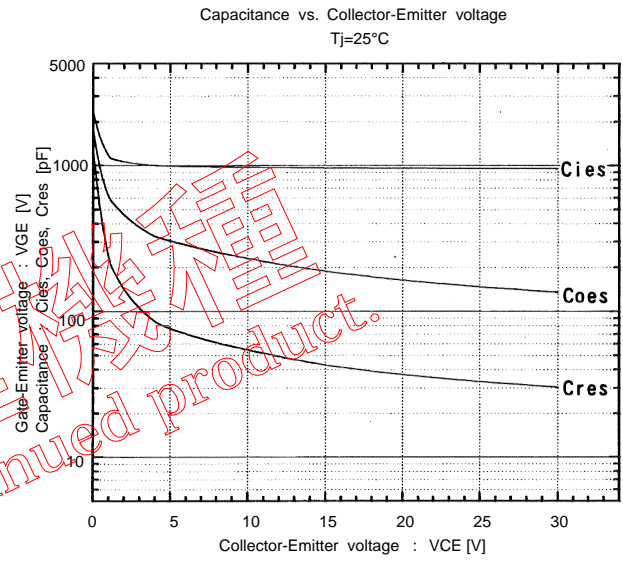
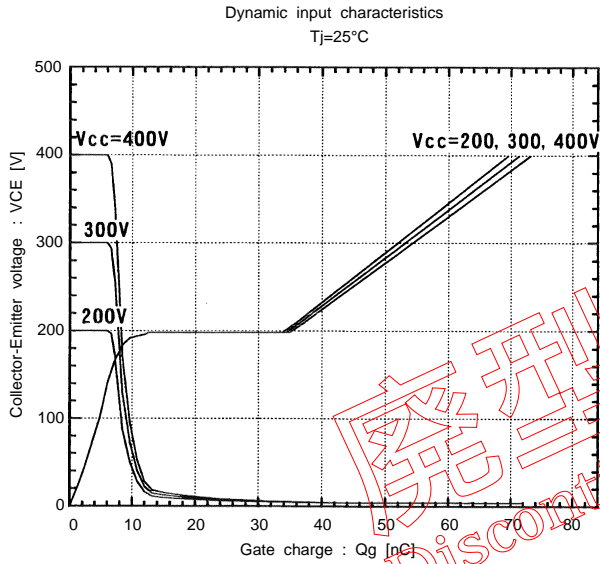
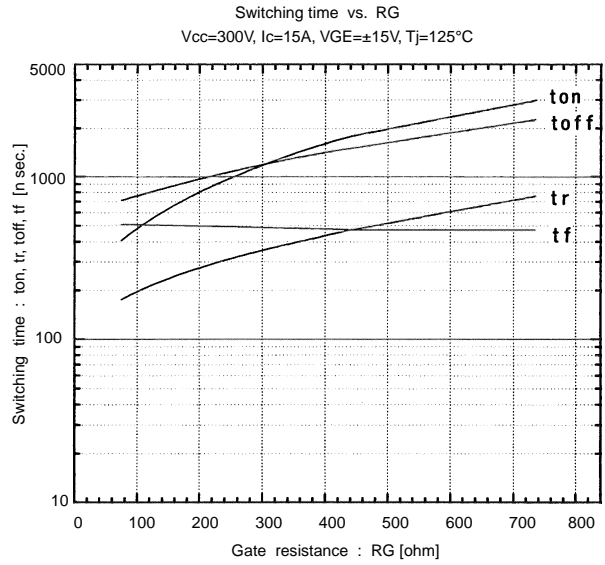
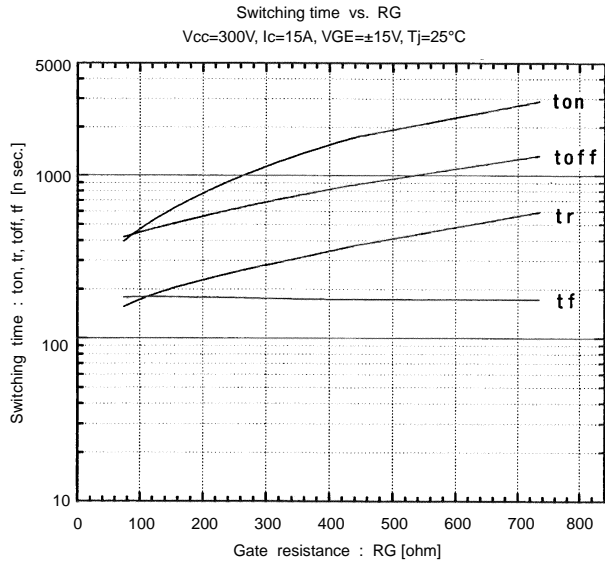

Switching loss vs. Collector current
 $V_{cc}=300V, R_G=150\ \Omega, V_{GE}=\pm 15V, T_j=125^\circ C$

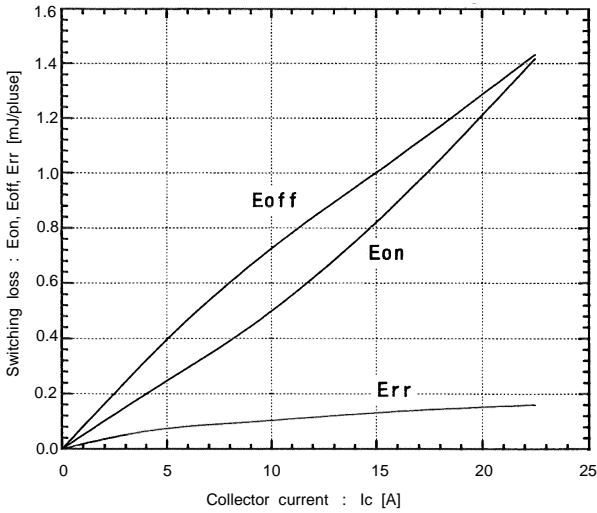

Switching loss vs. Gate resistance
 $V_{cc}=300V, I_c=15A, V_{GE}=\pm 15V, T_j=125^\circ C$

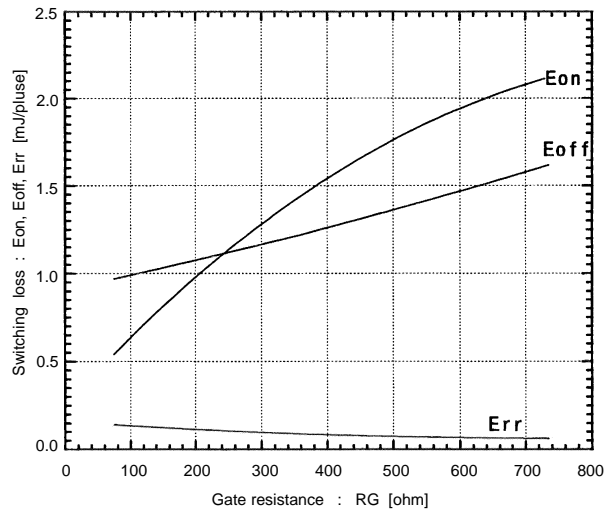

Forward current vs. Forward voltage

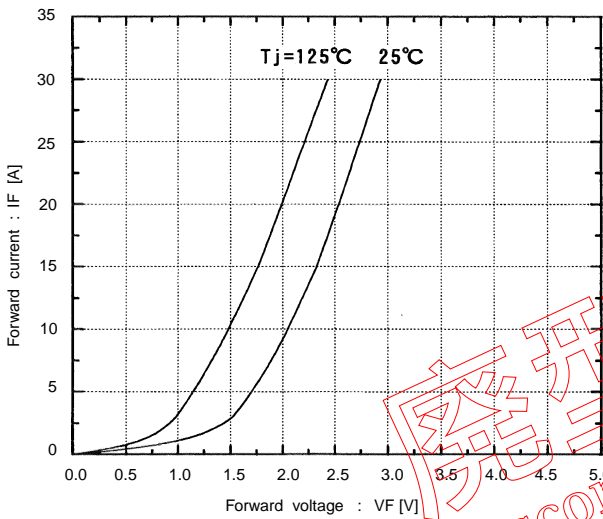

Reverse recovery characteristics
 t_{rr}, I_{rr} vs. I_F

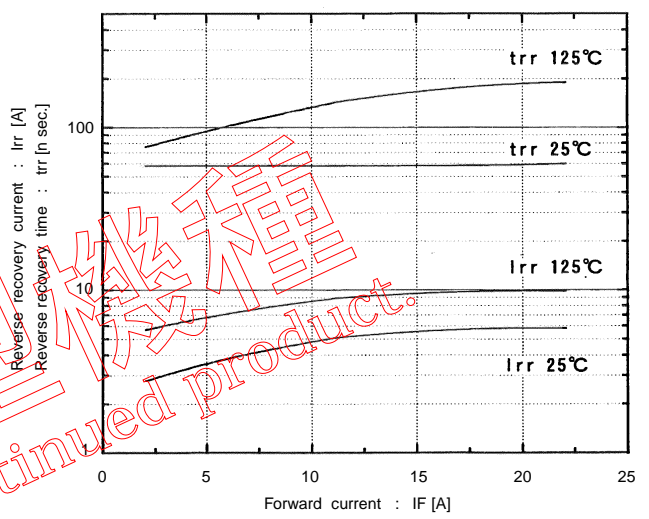

Outline Drawings, mm

