

IGBT MODULE (L series)

■ Features

- High Speed Switching
- Low Saturation Voltage
- Voltage Drive

■ Applications

- Inverter for Motor Drive
- AC and DC Servo Drive Amplifier
- Uninterruptible Power Supply
- Industrial Machines, such as Welding Machines

■ Maximum Ratings and Characteristics

● Absolute Maximum Ratings

Items	Symbols	Ratings	Units
Collector-Emitter Voltage	V_{CES}	1200	V
Gate-Emitter Voltage	V_{GES}	± 20	V
Collector Current	Continuous	I_C	50
	1ms	$I_{C\ pulse}$	100
	Continuous	$-I_C$	50
	1ms	$-I_{C\ pulse}$	100
Max. Power Dissipation	P_C	400	W
Operating Temperature	T_j	+150	$^{\circ}C$
Storage Temperature	T_{stg}	-40 to +125	$^{\circ}C$
Net. Weight		510	g
Isolation Voltage	AC. 1min.	V_{isol}	2500
Screw Torque	Mounting *1	35	kg \cdot cm
	Terminals *2	17	

● Electrical Characteristics ($T_c=25^{\circ}C$)

Items	Symbols	Test Conditions	Min.	Typ.	Max.	Units
Zero Gate Voltage Collector Current	I_{CES}	$V_{GE}=0V\ V_{CE}=1200V\ T_c=25^{\circ}C$			1.0	mA
		$V_{GE}=0V\ V_{CE}=1200V\ T_c=125^{\circ}C$			-	
Gate-Emitter Leakage Current	I_{GES}	$V_{CE}=0V\ V_{GE}=\pm 20V$			100	nA
Gate-Emitter Threshold Voltage	$V_{GE(th)}$	$V_{CE}=20V\ I_C=50mA$	3.0		6.0	V
Collector-Emitter Saturation Voltage	$V_{CE(sat)}$	$V_{GE}=15V\ I_C=50A$		2.7	3.5	V
Input Capacitance	C_{ies}	$V_{GE}=0V$		9000		pF
Output Capacitance	C_{oes}	$V_{CE}=10V$		-		
Reverse Transfer Capacitance	C_{res}	$f=1MHz$		-		
Turn-on Time	t_{on}	$V_{CC}=600V$		0.5	0.8	μs
	t_r	$I_C=50A$		0.3	0.6	
Turn-off Time	t_{off}	$V_{GE}=\pm 15V$		0.8	1.5	
	t_f	$R_G=25\Omega$		0.3	0.5	
Diode Forward On-Voltage	V_F	$I_F=50A\ V_{GE}=0V$			2.5	V
Reverse Recovery Time	t_{rr}	$I_F=50A\ -di/dt=150A/\mu s\ V_{GE}=-10V$		200	350	ns

● Thermal Characteristics

Items	Symbols	Test Conditions	Min.	Typ.	Max.	Units
Thermal Resistance	$R_{th(j-c)}$	IGBT			0.312	$^{\circ}C/W$
	$R_{th(j-e)}$	Diode			0.60	
	$R_{th(c-f)}$	With Thermal compound		0.05		

■ Outline Drawings

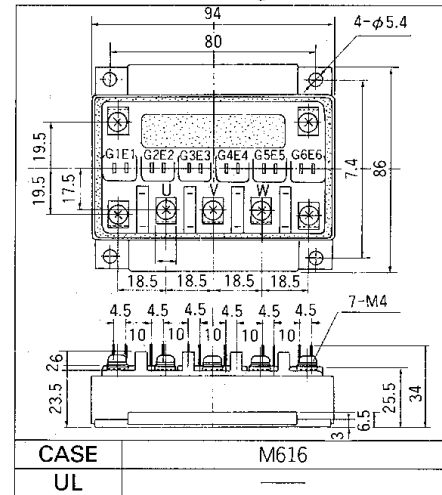

■ Equilavelent Circuit Schematic

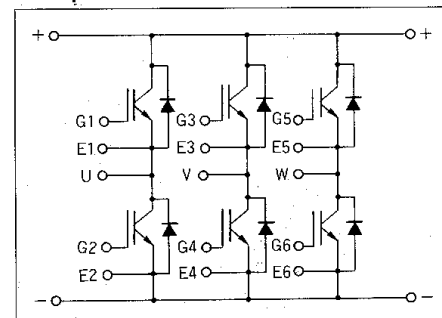

*1 Recommendable Value 25 to 35kg \cdot cm (M5)
*2 Recommendable Value 13 to 17kg \cdot cm (M4)

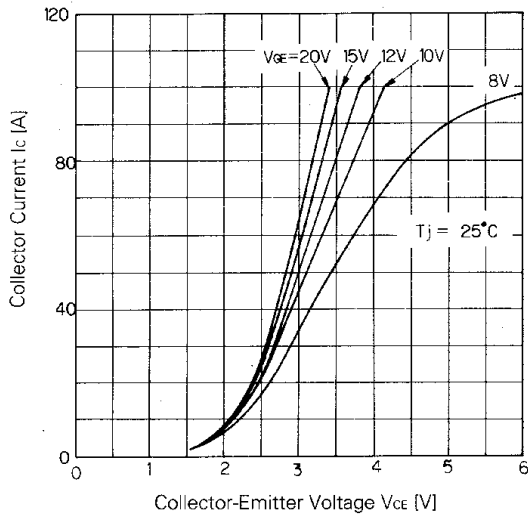

Collector Current vs. Collector-Emitter Voltage

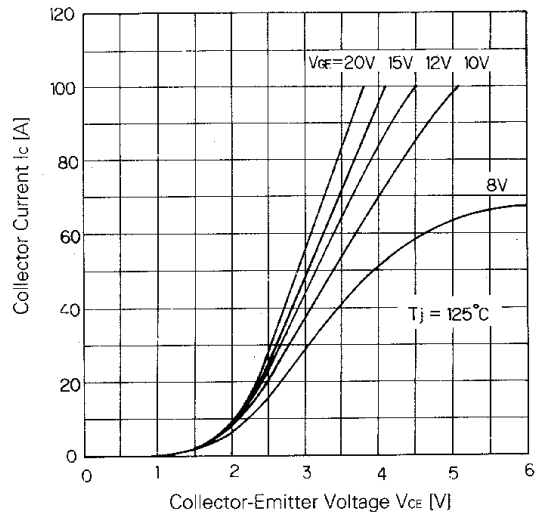

Collector Current vs. Collector-Emitter Voltage

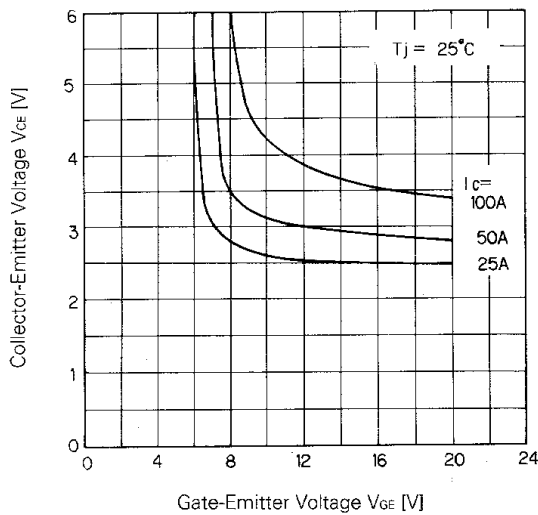

Collector-Emitter Voltage vs. Gate-Emitter Voltage

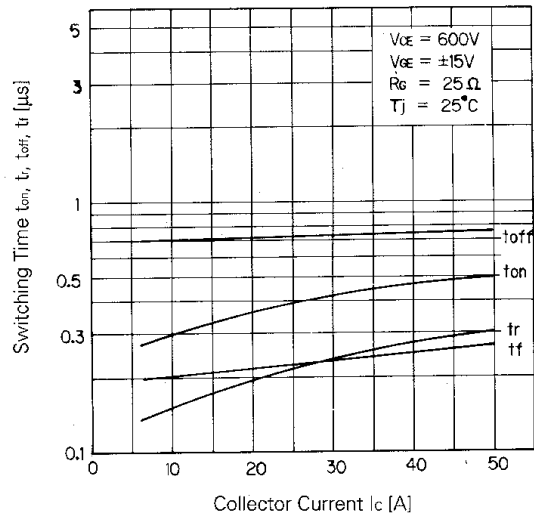

Switching Time

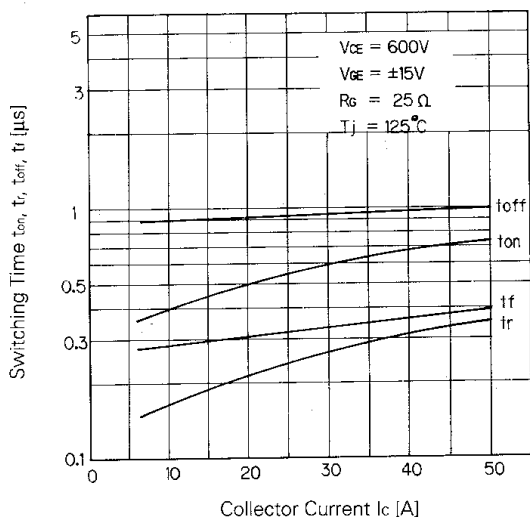

Switching Time

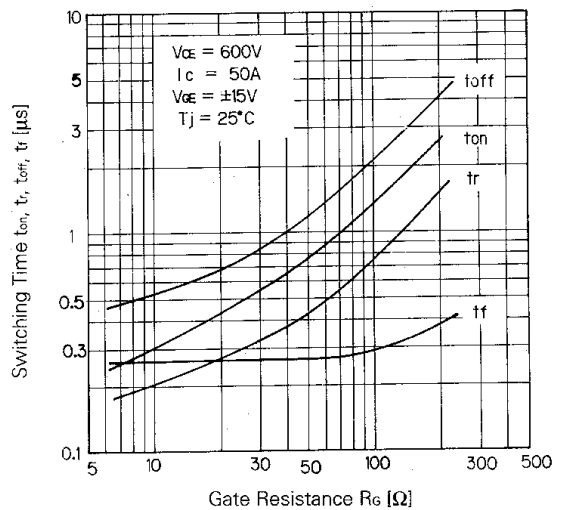

Switching Time-Gate Resistance

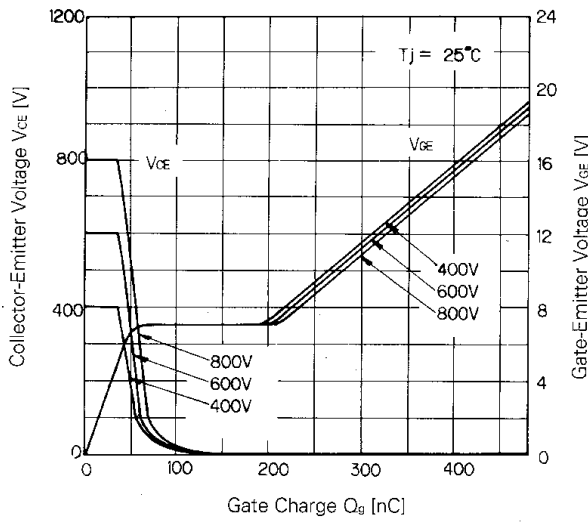

Dynamic Input Characteristic

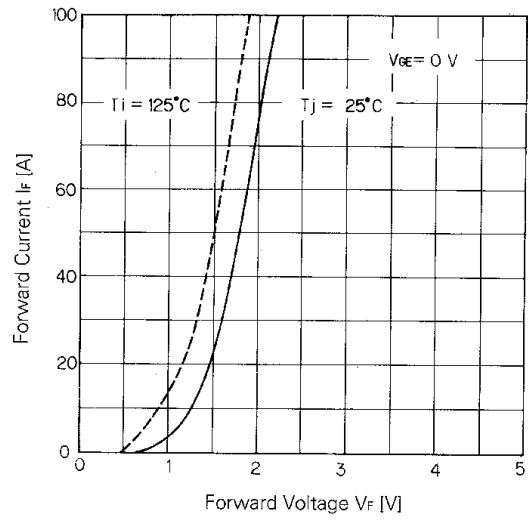

Forward Voltage of Free Wheel Diode

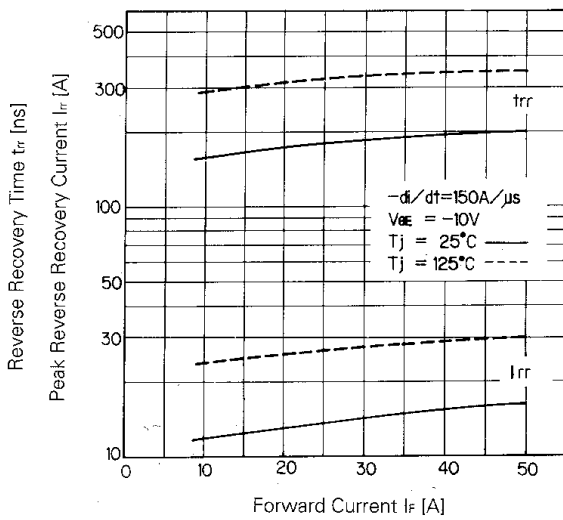

$t_{rr}, I_{rr}-I_F$

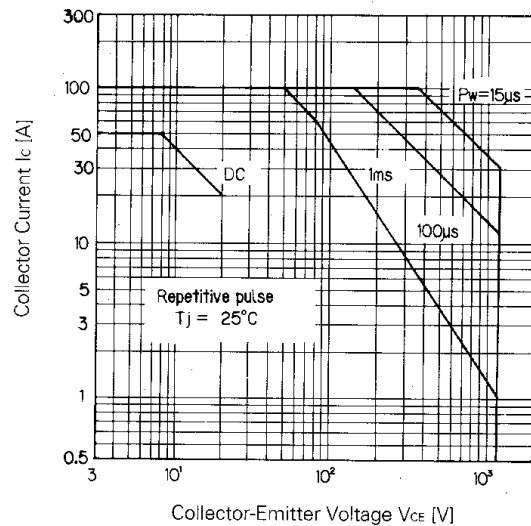

Safe Operating Area

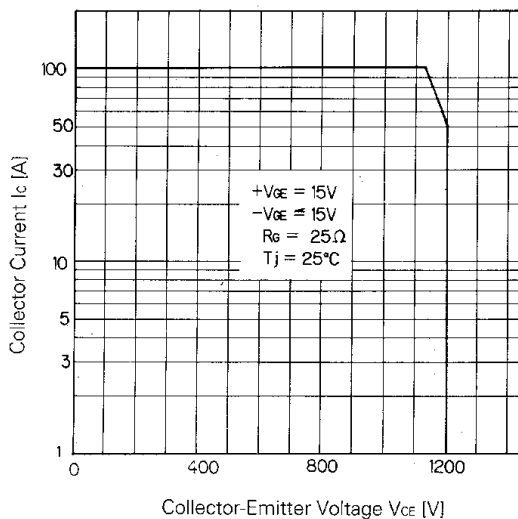

Reverse Biased Safe Operating Area

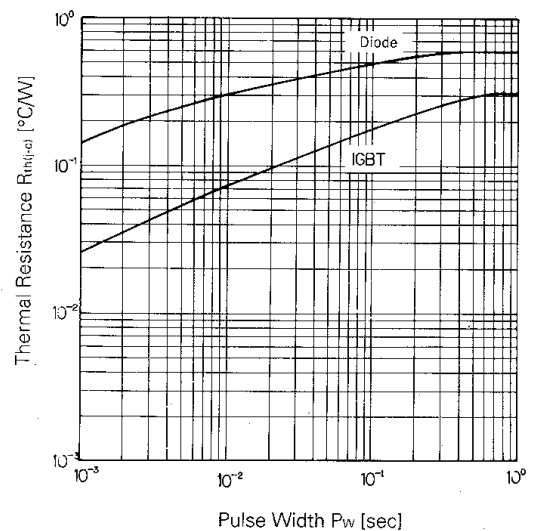

Transient Thermal Resistance

For more information, contact:

Collmer Semiconductor, Inc.

P.O. Box 702708

Dallas, TX 75370

972-733-1700

972-381-9991 Fax

<http://www.collmer.com>