

6MBP25RA120

IGBT-IPM R series

1200V / 25A 6 in one-package

Features

- Temperature protection provided by directly detecting the junction temperature of the IGBTs
- Low power loss and soft switching
- Compatible with existing IPM-N series packages
- High performance and high reliability IGBT with overheating protection
- Higher reliability because of a big decrease in number of parts in built-in control circuit

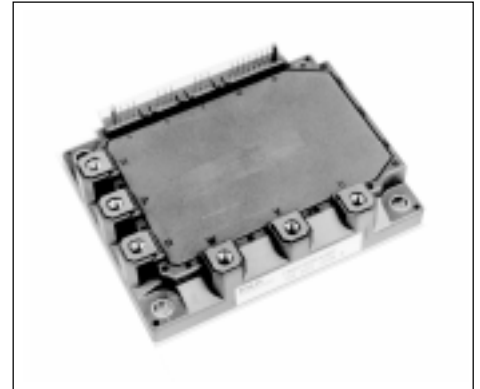

Maximum ratings and characteristics

- Absolute maximum ratings(at $T_c=25^\circ\text{C}$ unless otherwise specified)

Item	Symbol	Rating		Unit		
		Min.	Max.			
DC bus voltage	V_{DC}	0	900	V		
DC bus voltage (surge)	$V_{DC(surge)}$	0	1000	V		
DC bus voltage (short operating)	V_{SC}	200	800	V		
Collector-Emitter voltage	V_{CES}	0	1200	V		
INV	Collector current	DC	I_C	-	25	A
		1ms	I_{CP}	-	50	A
		DC	$-I_C$	-	25	A
	Collector power dissipation	One transistor	P_C	-	198	W
Junction temperature	T_J	-	150	$^\circ\text{C}$		
Input voltage of power supply for Pre-Driver	V_{CC}^*1	0	20	V		
Input signal voltage	V_{in}^*2	0	V_z	V		
Input signal current	I_{in}	-	1	mA		
Alarm signal voltage	V_{ALM}^*3	0	V_{CC}	V		
Alarm signal current	I_{ALM}^*4	-	15	mA		
Storage temperature	T_{stg}	-40	125	$^\circ\text{C}$		
Operating case temperature	T_{op}	-20	100	$^\circ\text{C}$		
Isolating voltage (Case-Terminal)	V_{iso}^*5	-	AC2.5	kV		
Screw torque	Mounting (M5)	-	3.5 *6	N·m		
	Terminal (M5)	-	3.5 *6	N·m		

*1 Apply V_{CC} between terminal No. 3 and 1, 6 and 4, 9 and 7, 11 and 10.

*2 Apply V_{in} between terminal No. 2 and 1, 5 and 4, 8 and 7, 13,14,15 and 10.

*3 Apply V_{ALM} between terminal No. 16 and 10.

*4 Apply I_{ALM} to terminal No. 16.

*5 50Hz/60Hz sine wave 1 minute.

*6 Recommendable Value : 2.5 to 3.0 N·m

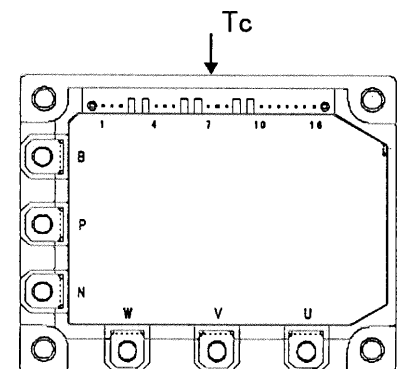

Fig.1 Measurement of case temperature

- Electrical characteristics of power circuit (at $T_c=T_J=25^\circ\text{C}$, $V_{CC}=15\text{V}$)

Item	Symbol	Condition	Min.	Typ.	Max.	Unit	
INV	Collector current at off signal input	I_{CES}	$V_{CE}=1200\text{V}$ input terminal open	-	-	1.0	mA
	Collector-Emitter saturation voltage	$V_{CE(sat)}$	$I_C=25\text{A}$	-	-	2.6	V
	Forward voltage of FWD	V_F	$-I_C=25\text{A}$	-	-	3.0	V

● Electrical characteristics of control circuit(at $T_c=T_j=25^{\circ}\text{C}$, $V_{cc}=15\text{V}$)

Item	Symbol	Condition	Min.	Typ.	Max.	Unit
Power supply current of P-line side Pre-driver(one unit)	I_{ccp}	$f_{sw}=0$ to 15kHz $T_c=-20$ to 100°C *7	3	-	18	mA
Power supply current of N-line side three Pre-driver	I_{ccn}	$f_{sw}=0$ to 15kHz $T_c=-20$ to 100°C *7	10	-	65	mA
Input signal threshold voltage (on/off)	$V_{in(th)}$	ON	1.00	1.35	1.70	V
		OFF	1.25	1.60	1.95	V
Input zener voltage	V_z	$R_{in}=20\text{k ohm}$	-	8.0	-	V
Over heating protection temperature level	T_{COH}	$V_{DC}=0\text{V}$, $I_c=0\text{A}$, Case temperature	110	-	125	$^{\circ}\text{C}$
Hysteresis	T_{CH}		-	20	-	$^{\circ}\text{C}$
IGBT chips over heating protection temperature level	T_{jOH}	surface of IGBT chips	150	-	-	$^{\circ}\text{C}$
Hysteresis	T_{jH}		-	20	-	$^{\circ}\text{C}$
Collector current protection level	INV	I_{oc}	$T_j=125^{\circ}\text{C}$	38	-	A
Over current protection delay time	t_{DOC}	$T_j=25^{\circ}\text{C}$ Fig.2	-	10	-	μs
Under voltage protection level	V_{UV}		11.0	-	12.5	V
Hysteresis	V_H		0.2	-	-	V
Alarm signal hold time	t_{ALM}		1.5	2	-	ms
SC protection delay time	t_{SC}	$T_j=25^{\circ}\text{C}$ Fig.3	-	-	12	μs
Limiting resistor for alarm	R_{ALM}		1425	1500	1575	ohm

*7 Switching frequency of IPM

● Dynamic characteristics(at $T_c=T_j=125^{\circ}\text{C}$, $V_{cc}=15\text{V}$)

Item	Symbol	Condition	Min.	Typ.	Max.	Unit
Switching time (IGBT)	t_{on}	$I_C=25\text{A}$, $V_{DC}=600\text{V}$	0.3	-	-	μs
	t_{off}		-	-	3.6	μs
Switching time (FWD)	t_{rr}	$I_F=25\text{A}$, $V_{DC}=600\text{V}$	-	-	0.4	μs

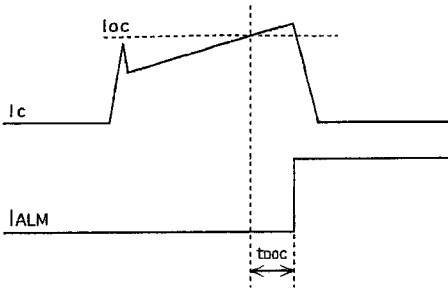

Fig.2 Definition of OC delay time

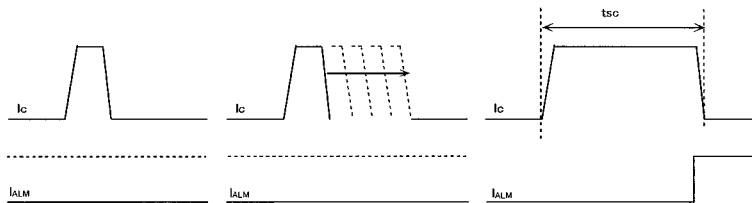

Fig.3 Definition of tsc

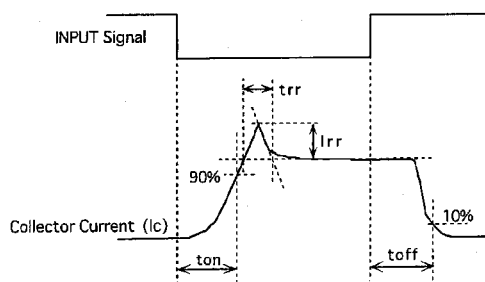

Fig.4 Definition of switching time

● Thermal characteristics($T_c=25^{\circ}\text{C}$)

Item	Symbol	Typ.	Max.	Unit
Junction to Case thermal resistance	INV			
	IGBT	-	0.63	$^{\circ}\text{C/W}$
	FWD	-	1.33	$^{\circ}\text{C/W}$
Case to fin thermal resistance with compound	$R_{th(c-f)}$	0.05	-	$^{\circ}\text{C/W}$

● Recommendable value

Item	Symbol	Min.	Typ.	Max.	Unit
DC bus voltage	V_{DC}	200	-	800	V
Operating power supply voltage range of Pre-driver	V_{cc}	13.5	15	16.5	V
Switching frequency of IPM	f_{sw}	1	-	20	kHz
Screw torque	Mounting (M5)	-	2.5	3.0	N·m
	Terminal (M5)	-	2.5	3.0	N·m

Block diagram

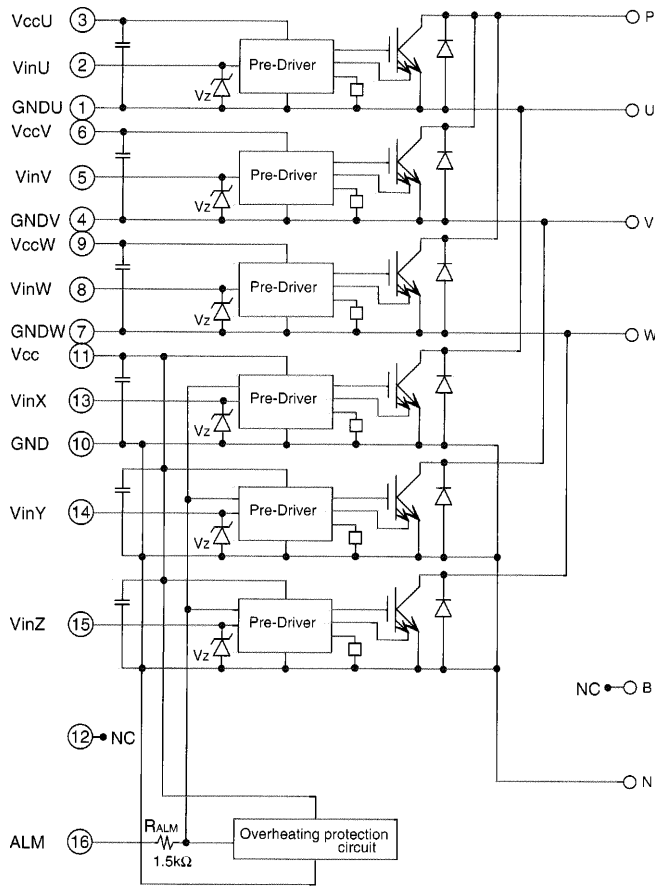

- Pre-drivers include following functions
- a) Amplifier for driver
 - b) Short circuit protection
 - c) Undervoltage lockout circuit
 - d) Over current protection
 - e) IGBT chip over heating protection

Outline drawings, mm

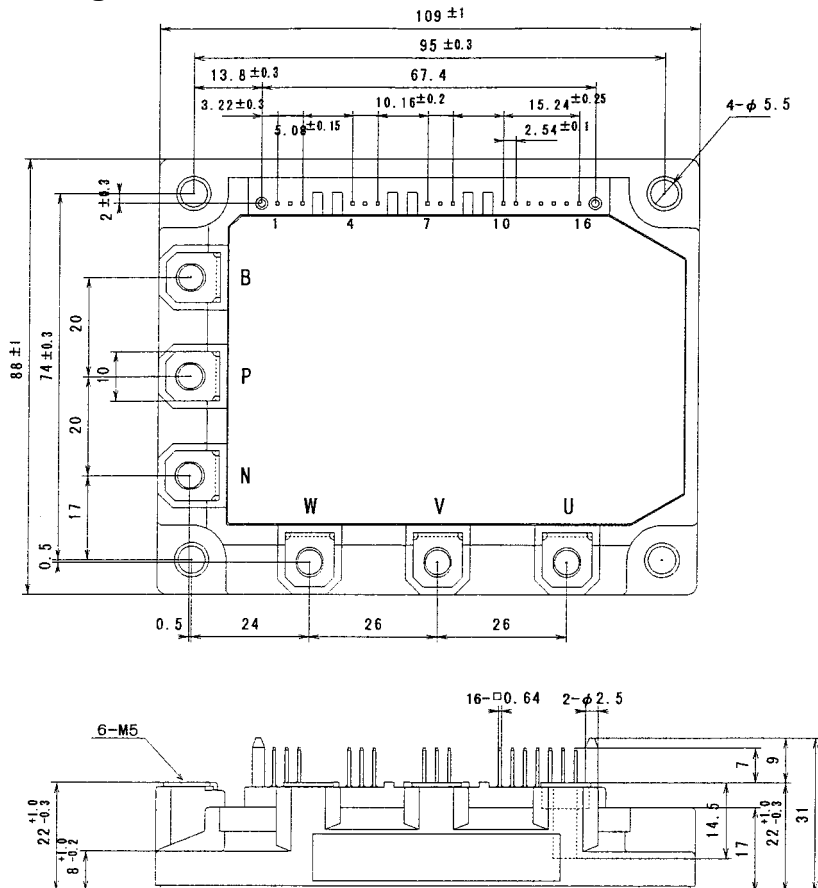

Mass : 440g

Characteristics (Representative)

Control Circuit

Power supply current vs. Switching frequency
T_j=100°C

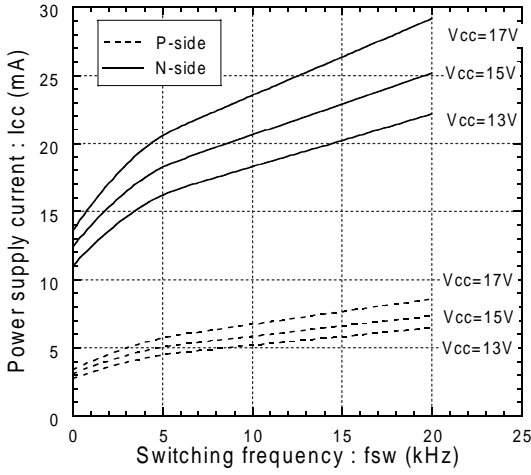

Input signal threshold voltage vs. Power supply voltage

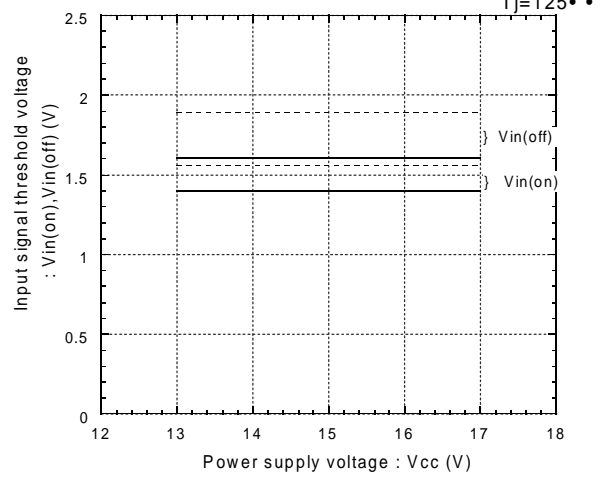

Under voltage vs. Junction temperature

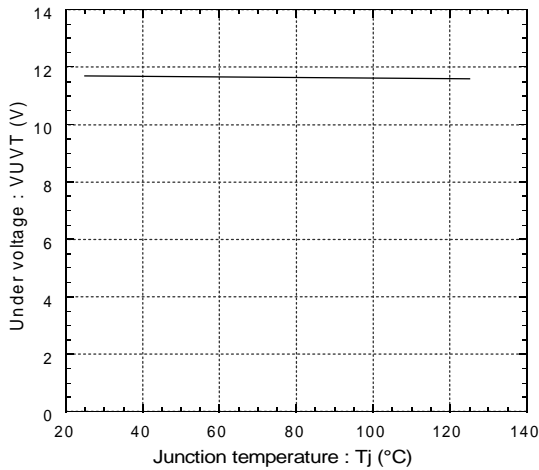

Under voltage hysteresis vs. Junction temperature

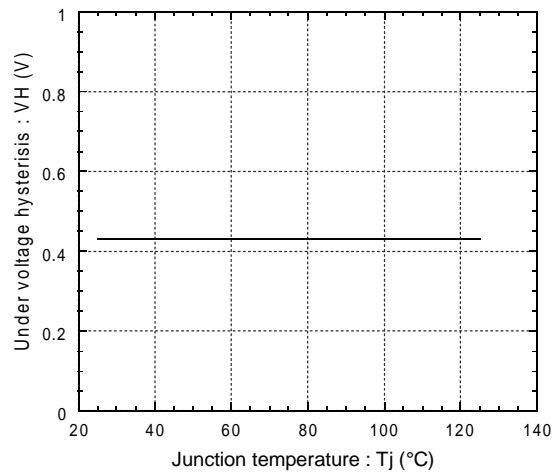

Alarm hold time vs. Power supply voltage

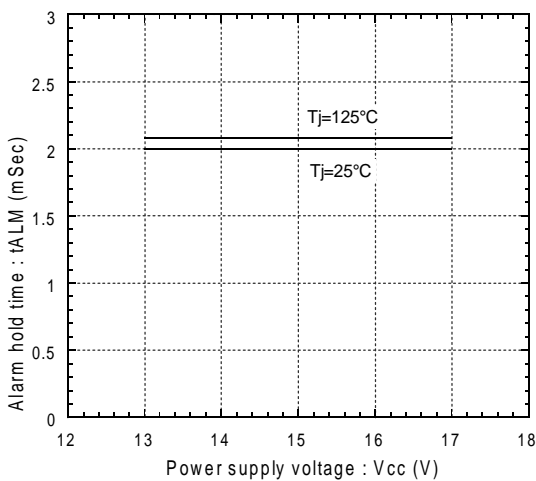

Over heating characteristics
TcOH, TjOH, TcH, TjH vs. Vcc

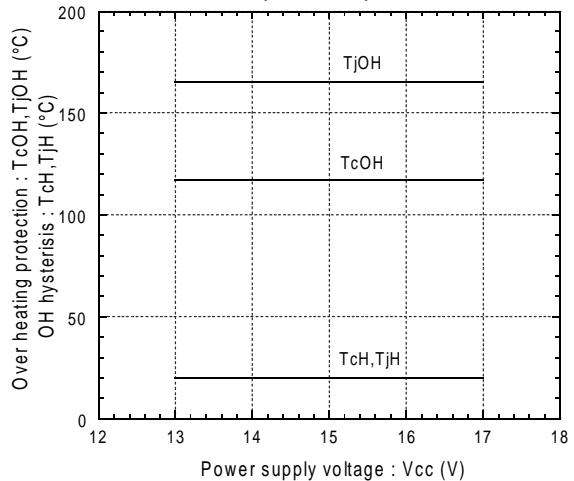

● Inverter

Collector current vs. Collector-Emittter voltage
Tj=25°C

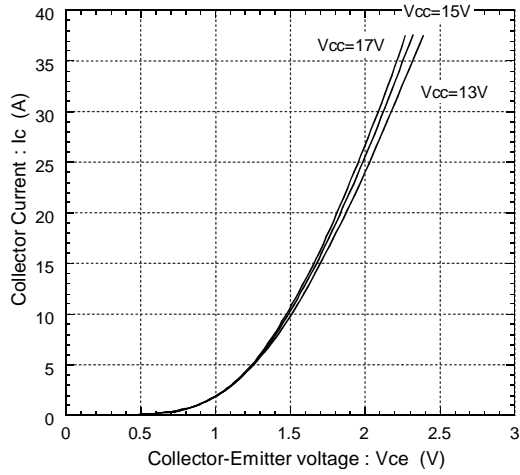

Collector current vs. Collector-Emittter voltage
Tj=125°C

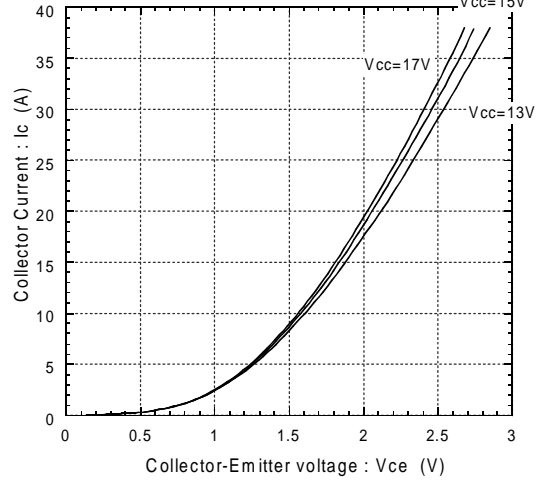

Switching time vs. Collector current
Edc=600V, Vcc=15V, Tj=25°C

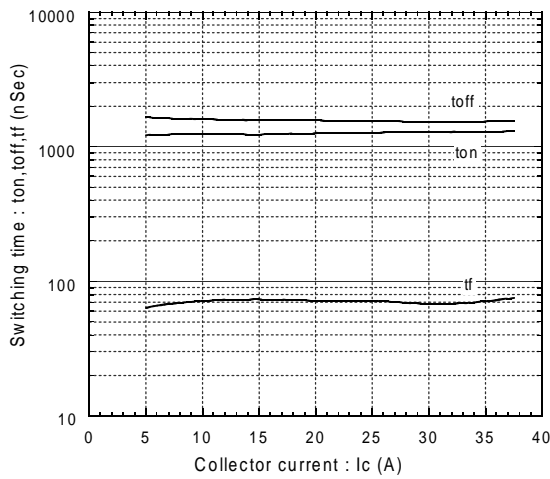

Switching time vs. Collector current
Edc=600V, Vcc=15V, Tj=125°C

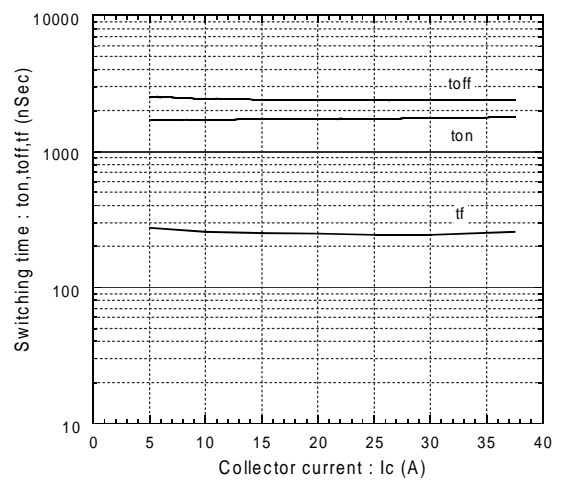

Forward current vs. Forward voltage

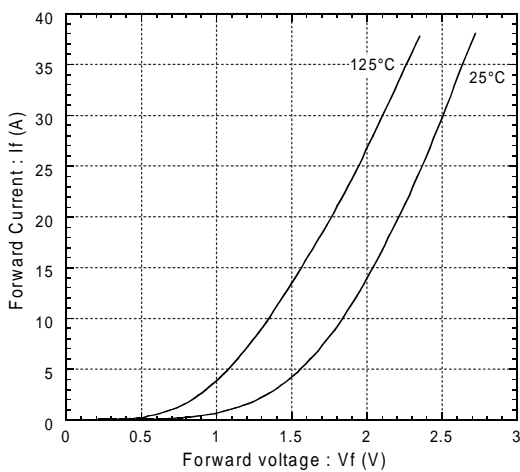

Reverse recovery characteristics
trr, Irr vs. IF

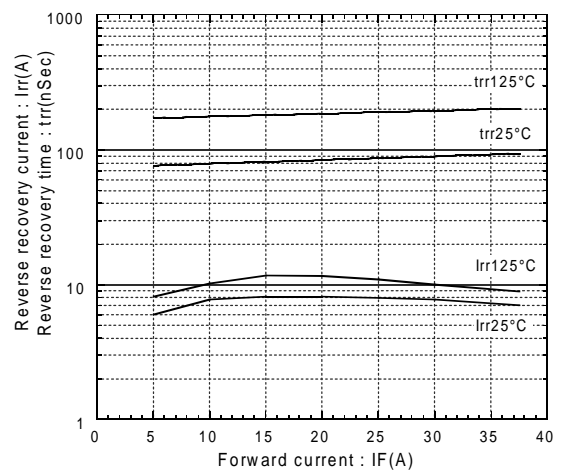

Transient thermal resistance

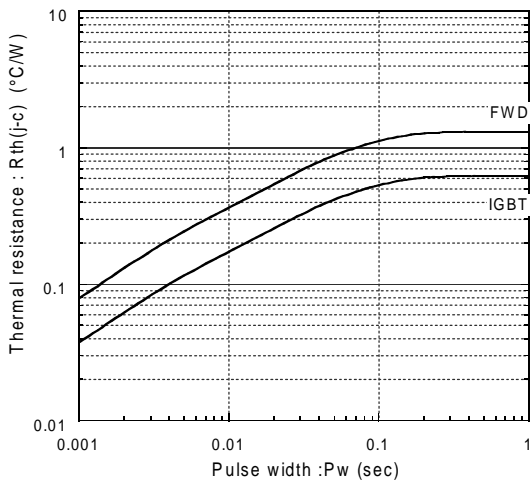

Reversed biased safe operating area
Vcc=15V, Tj ≤ 125°C

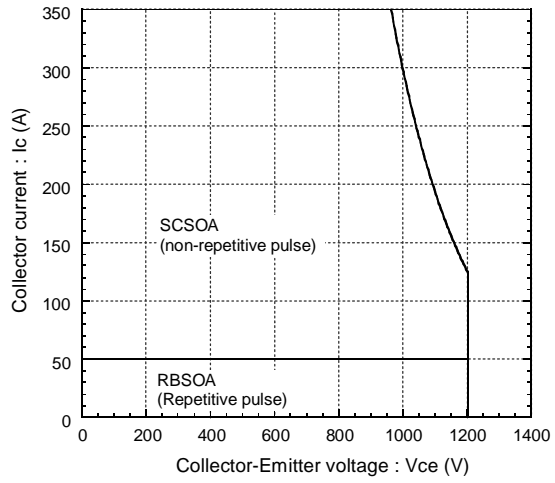

Power derating for IGBT
(per device)

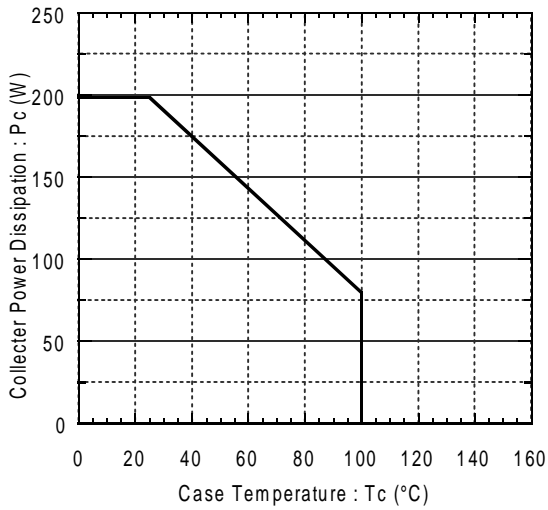

Power derating for FWD
(per device)

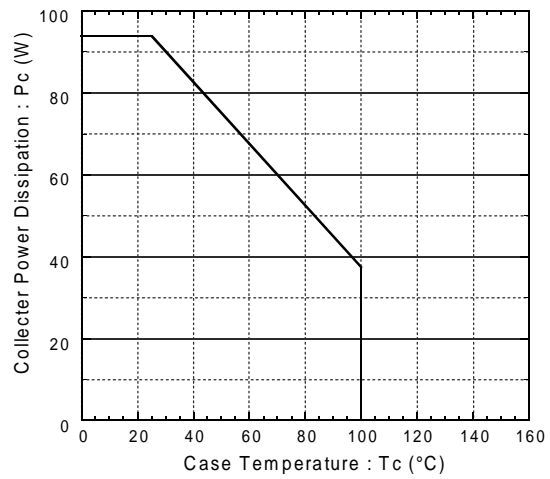

Switching Loss vs. Collector Current
Edc=600V, Vcc=15V, Tj=25°C

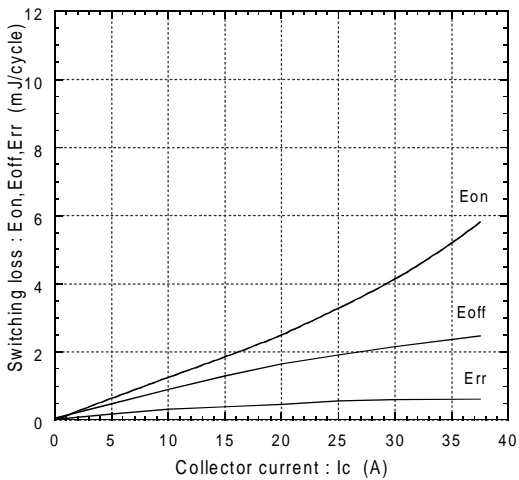

Switching Loss vs. Collector Current
Edc=600V, Vcc=15V, Tj=125°C

