

■ Features

- Temperature protection provided by directly detecting the junction temperature of the IGBTs.
- Low power loss and soft switching.
- High performance and high reliability IGBT with overheating protection.
- Both P-side and N-side alarm output available.
- Higher reliability because of a big decrease in number of parts in built-in control circuit.

■ Maximum ratings and characteristics

- Absolute maximum ratings(at Tc=25°C unless otherwise specified)

| Item | | Symbol | Rating | | Unit | |
|---|-----------------------------|------------------------|-----------------|----------------------|------|---|
| | | | Min. | Max. | | |
| Bus voltage | DC | V _{DC} | 0 | 900 | V | |
| | Surge | V _{DC(surge)} | 0 | 1000 | V | |
| | Short operating | V _{SC} | 200 | 800 | V | |
| Collector-Emitter voltage *1 | | V _{CES} | 0 | 1200 | V | |
| Inverter | Collector current | DC | I _C | - | 50 | A |
| | | 1ms | I _{CP} | - | 100 | A |
| | | Duty=98.0% *2 | -I _C | - | 50 | A |
| | Collector power dissipation | One transistor *3 | P _C | - | 357 | W |
| Supply voltage of Pre-Driver *4 | | V _{CC} | -0.5 | 20 | V | |
| Input signal voltage *5 | | V _{in} | -0.5 | V _{CC} +0.5 | V | |
| Input signal current | | I _{in} | - | 3 | mA | |
| Alarm signal voltage *6 | | V _{ALM} | -0.5 | V _{CC} | V | |
| Alarm signal current *7 | | I _{ALM} | - | 20 | mA | |
| Junction temperature | | T _j | - | 150 | °C | |
| Operating case temperature | | T _{opr} | -20 | 100 | °C | |
| Storage temperature | | T _{stg} | -40 | 125 | °C | |
| Isolating voltage (Terminal to base, 50/60Hz sine wave 1min.) | | V _{iso} | - | AC2500 | V | |
| Screw torque | Terminal (M5) | | - | 3.5 | N·m | |
| | Mounting (M5) | | - | 3.5 | N·m | |

Note

*1 : V_{CES} shall be applied to the input voltage between terminal P and U or ,u or W, N and U or V or W

*2 : $125^{\circ}\text{C}/\text{FWD } R_{\text{th}}(\text{j-c})/(\text{Ic} \times \text{VF MAX})=125/0.85/(50 \times 3.0) \times 100=98.0\%$

*3 : $P_c=125^{\circ}\text{C}/\text{IGBT } R_{\text{th}}(\text{j-c})=125/0.35=357\text{W}$ [Inverter]

*4 : V_{CC} shall be applied to the input voltage between terminal No.4 and 1, 8 and 5, 12 and 9, 14 and 13

*5 : V_{in} shall be applied to the input voltage between terminal No.3 and 1, 7 and 5, 11 and 9, 16,17,18 and 13.

*6 : V_{ALM} shall be applied to the voltage between terminal No.2 and 1, No6 and 5, No10 and 9, No.19 and 13.

*7 : I_{ALM} shall be applied to the input current to terminal No.2,6,10 and 19.

Electrical characteristics (at $T_c=T_j=25^\circ\text{C}$, $V_{cc}=15\text{V}$ unless otherwise specified.)

● Main circuit

| Item | | Symbol | Condition | Min. | Typ. | Max. | Unit | |
|-----------------------|---------------------------------------|---------------|--|----------|------|------|---------------|---|
| Inverter | Collector current at off signal input | ICES | $V_{CE}=1200\text{V}$ V_{in} terminal open. | - | - | 1.0 | mA | |
| | Collector-Emitter saturation voltage | $V_{CE(sat)}$ | $I_c=50\text{A}$ | Terminal | - | - | 2.6 | V |
| | | | | Chip | - | 1.9 | - | |
| | Forward voltage of FWD | VF | $-I_c=50\text{A}$ | Terminal | - | - | 3.0 | V |
| Chip | | | | - | 2.3 | - | | |
| Turn-on time | | ton | $V_{DC}=600\text{V}$, $T_j=125^\circ\text{C}$ | 1.2 | - | - | μs | |
| Turn-off time | | toff | $I_c=50\text{A}$ Fig.1, Fig.6 | - | - | 3.6 | | |
| Reverse recovery time | | trr | $V_{DC}=600\text{V}$, $I_F=50\text{A}$ Fig.1, Fig.6 | - | - | 0.3 | | |

● Control circuit

| Item | Symbol | Condition | Min. | Typ. | Max. | Unit |
|--|--------------|--|------|------|------|------|
| Supply current of P-line side pre-driver(one unit) | I_{ccp} | Switching Frequency : 0 to 15kHz $T_c=-20$ to 125°C Fig.7 | - | - | 18 | mA |
| Supply current of N-line side pre-driver | I_{ccn} | | - | - | 65 | mA |
| Input signal threshold voltage (on/off) | $V_{in(th)}$ | ON | 1.00 | 1.35 | 1.70 | V |
| | | OFF | 1.25 | 1.60 | 1.95 | V |
| Input zener voltage | VZ | $R_{in}=20\text{k}\Omega$ | - | 8.0 | - | V |
| Alarm signal hold time | tALM | $T_c=-20^\circ\text{C}$ Fig.2 | 1.1 | - | - | ms |
| | | $T_c=25^\circ\text{C}$ Fig.2 | - | 2.0 | - | ms |
| | | $T_c=125^\circ\text{C}$ Fig.2 | - | - | 4.0 | ms |
| Limiting Resistor for Alarm | RALM | | 1425 | 1500 | 1575 | ohm |

● Protection Section ($V_{cc}=15\text{V}$)

| Item | Symbol | Condition | Min. | Typ. | Max. | Unit |
|--|-----------|--|------|------|------|------------------|
| Over Current Protection Level of Inverter circuit | loc | $T_j=125^\circ\text{C}$ | 75 | - | - | A |
| Over Current Protection Delay time | tDOC | $T_j=125^\circ\text{C}$ | - | 10 | - | μs |
| SC Protection Delay time | tsc | $T_j=125^\circ\text{C}$ Fig.4 | - | - | 12 | μs |
| IGBT Chip Over Heating Protection Temperature Level | T_{jOH} | Surface of IGBT chips | 150 | - | - | $^\circ\text{C}$ |
| Over Heating Protection Hysteresis | T_{jH} | | - | 20 | - | $^\circ\text{C}$ |
| Over Heating Protection Protection Temperature Level | T_{cOH} | $V_{DC}=0\text{V}$, $I_c=0\text{A}$ Case Temperature | 110 | - | 125 | $^\circ\text{C}$ |
| Over Heating Protection Hysteresis | T_{cH} | | - | 20 | - | $^\circ\text{C}$ |
| Under Voltage Protection Level | VUV | | 11.0 | - | 12.5 | V |
| Under Voltage Protection Hysteresis | VH | | 0.2 | 0.5 | - | V |

● Thermal characteristics($T_c=25^\circ\text{C}$)

| Item | | | Symbol | Min. | Typ. | Max. | Unit |
|--|----------|------|---------------|------|------|------|---------------------------|
| Junction to Case thermal resistance *8 | Inverter | IGBT | $R_{th(j-c)}$ | - | - | 0.35 | $^\circ\text{C}/\text{W}$ |
| | | FWD | $R_{th(j-c)}$ | - | - | 0.85 | $^\circ\text{C}/\text{W}$ |
| Case to fin thermal resistance with compound | | | $R_{th(c-f)}$ | - | 0.05 | - | $^\circ\text{C}/\text{W}$ |

*8 : (For 1 device, Case is under the device)

● Noise Immunity ($V_{DC}=300\text{V}$, $V_{cc}=15\text{V}$, Test Circuit Fig.5)

| Item | Condition | Min. | Typ. | Max. | Unit |
|-------------------------------|--|-----------|------|------|------|
| Common mode rectangular noise | Pulse width $1\mu\text{s}$, polarity \pm , 10minuets Judge : no over-current, no miss operating | ± 2.0 | - | - | kV |
| Common mode lightning surge | Rise time $1.2\mu\text{s}$, Fall time $50\mu\text{s}$ Interval 20s, 10 times Judge : no over-current, no miss operating | ± 5.0 | - | - | kV |

● Recommendable value

| Item | Symbol | Min. | Typ. | Max. | Unit |
|--|----------|------|------|------|------|
| DC Bus Voltage | V_{DC} | - | - | 800 | V |
| Operating Supply Voltage of Pre-Driver | V_{cc} | 13.5 | 15.0 | 16.5 | V |
| Screw torque (M5) | - | 2.5 | - | 3.0 | Nm |

● Weight

| Item | Symbol | Min. | Typ. | Max. | Unit |
|--------|--------|------|------|------|------|
| Weight | Wt | - | 450 | - | g |

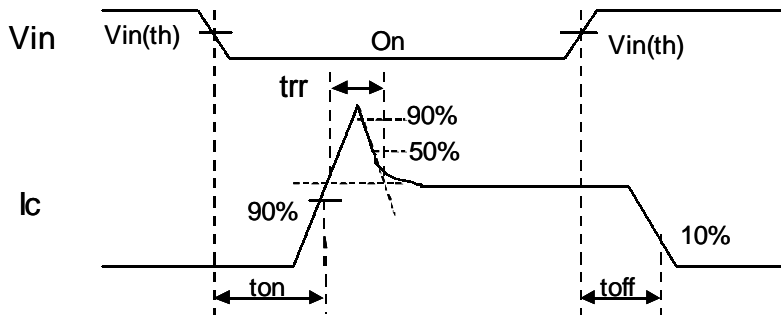

Figure 1. Switching Time Waveform Definitions



Fault : Over-current, Over-heat or Under-voltage

Figure 2. Input/Output Timing Diagram

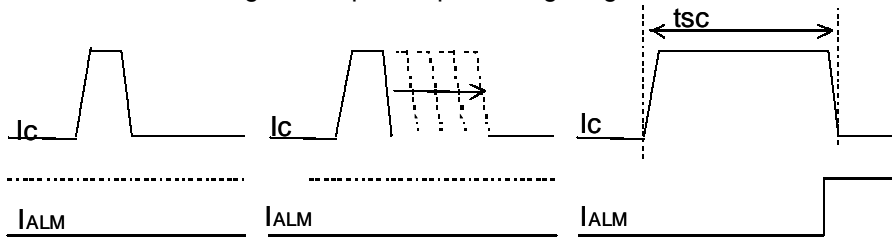

Figure.4 Definition of tsc



Figure 5. Noise Test Circuit

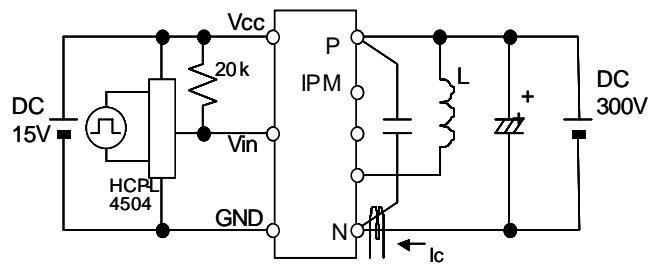
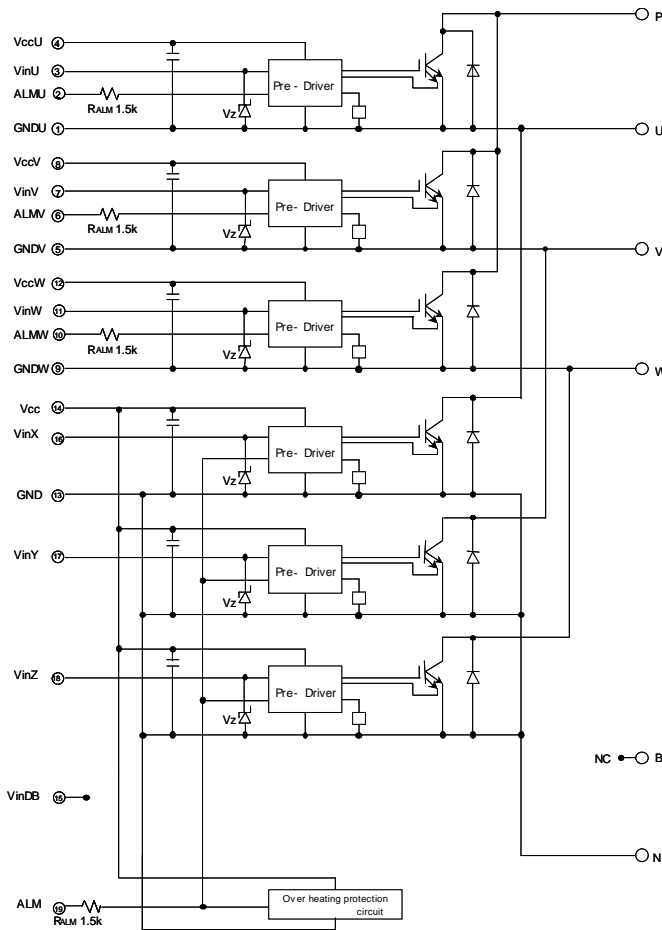

Figure 6. Switching Characteristics Test Circuit



Figure 7. Icc Test Circuit

Block diagram



Pre-drivers include following functions

1. Amplifier for driver
2. Short circuit protection
3. Under voltage lockout circuit
4. Over current protection
5. IGBT chip over heating protection

Outline drawings, mm

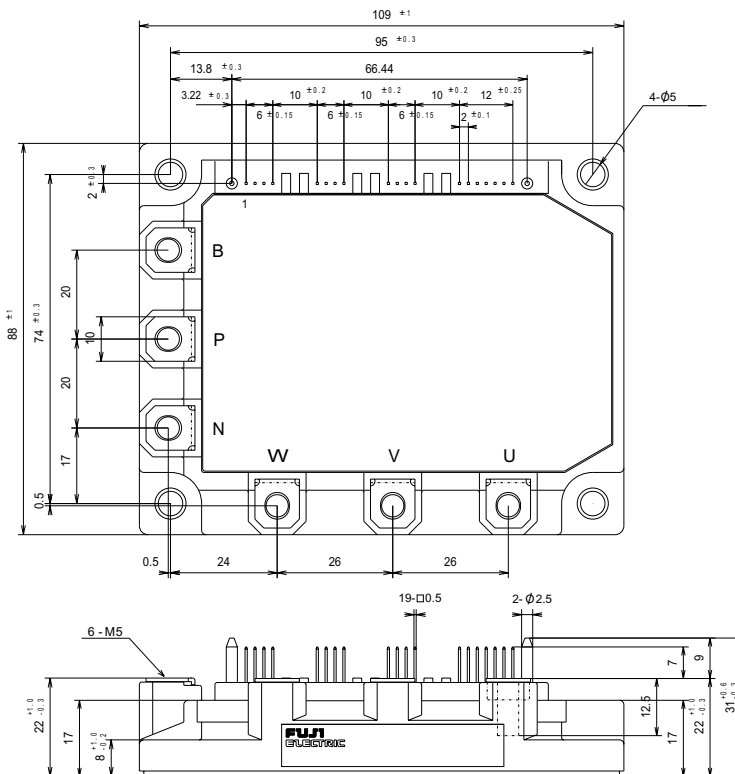

Mass : 450g

Characteristics

Control circuit characteristics (Representative)

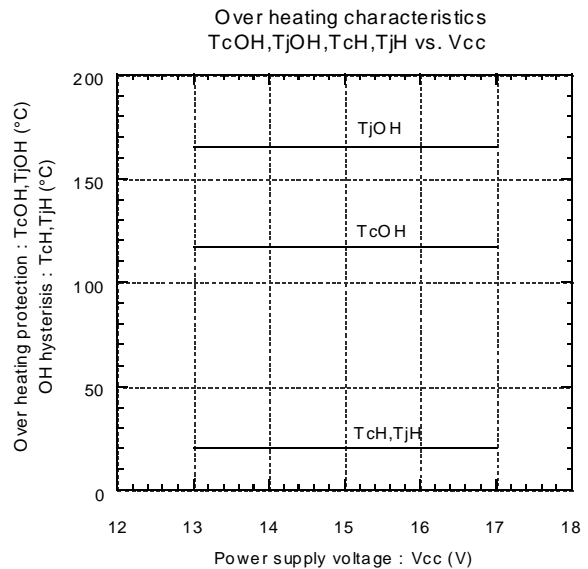
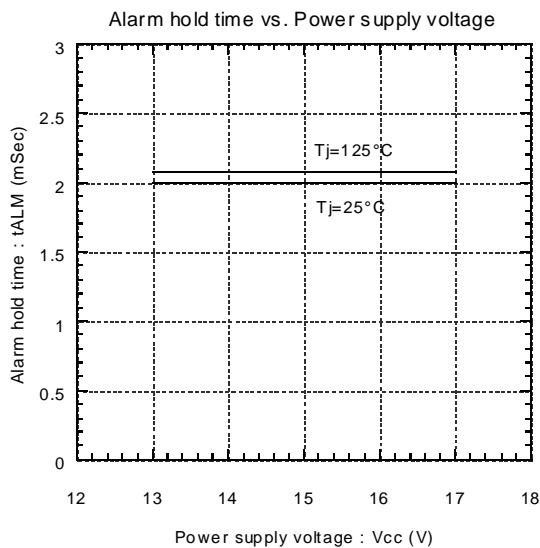
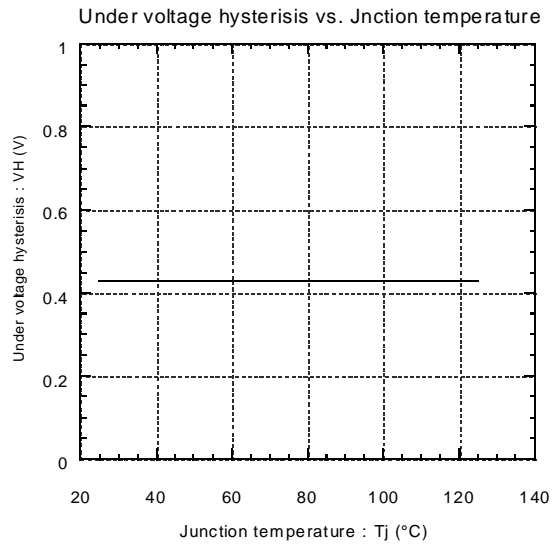
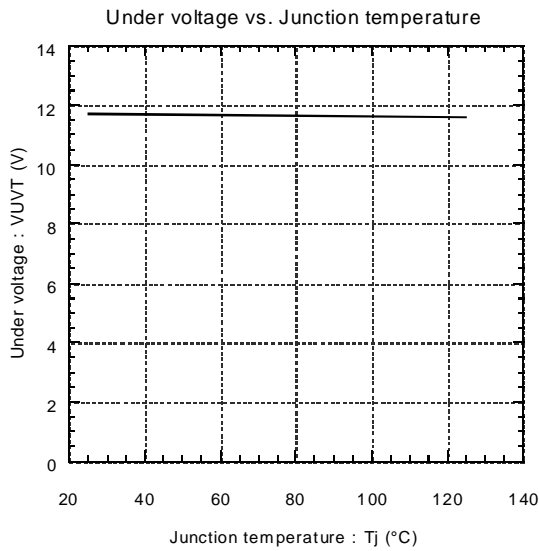
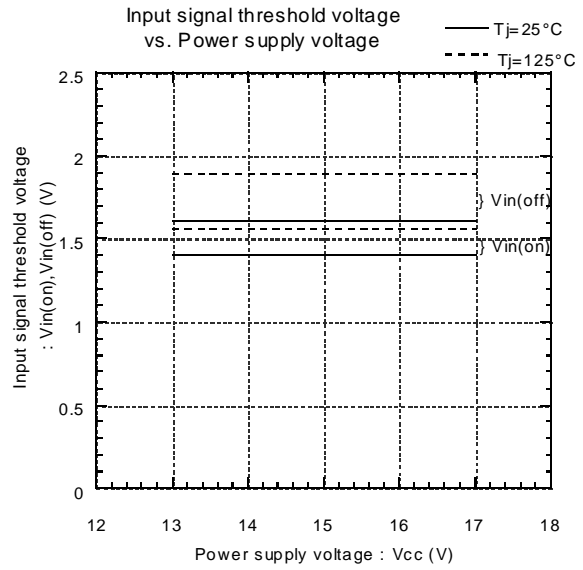
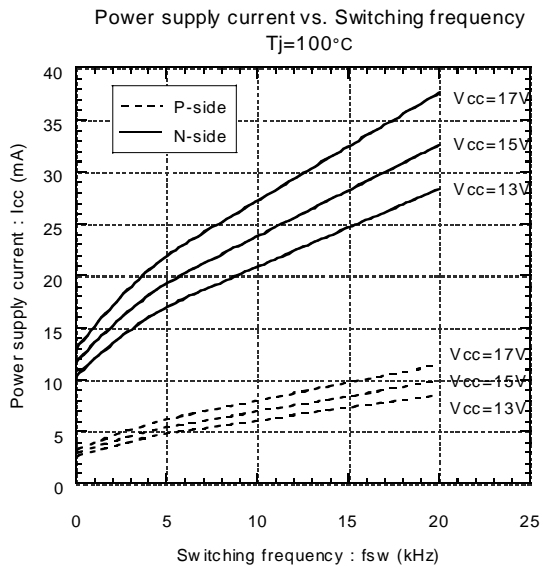

● Main circuit characteristics (Representative)

Collector current vs. Collector-Emitter voltage
Tj=25°C (Chip)

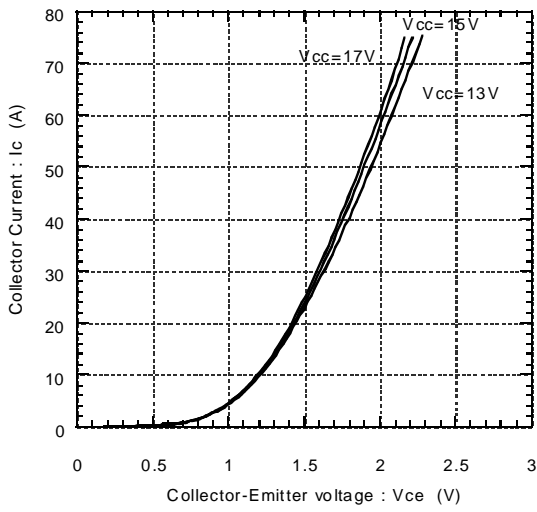

Collector current vs. Collector-Emitter voltage
Tj=25°C (Terminal)

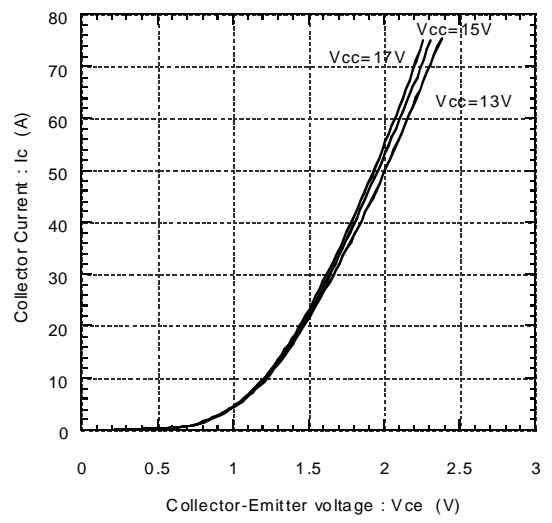

Collector current vs. Collector-Emitter voltage
Tj=125°C (Chip)

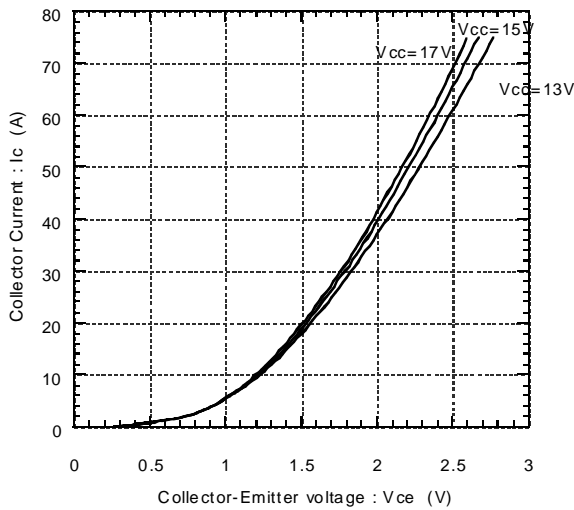

Collector current vs. Collector-Emitter voltage
Tj=125°C (Terminal)

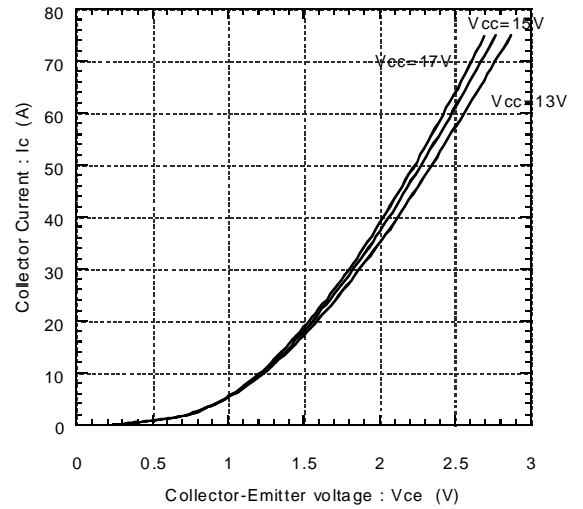

Forward current vs. Forward voltage
(Chip)

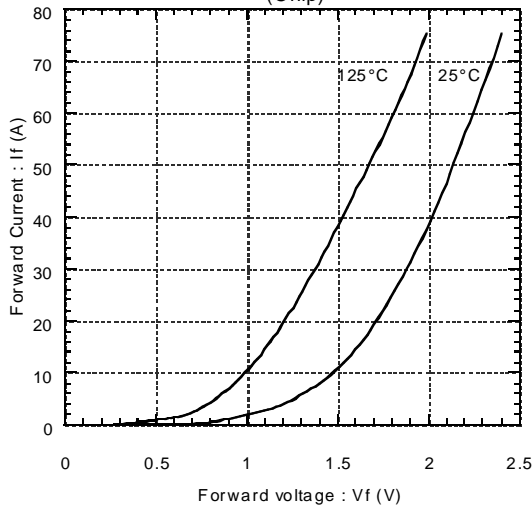

Forward current vs. Forward voltage
(Terminal)

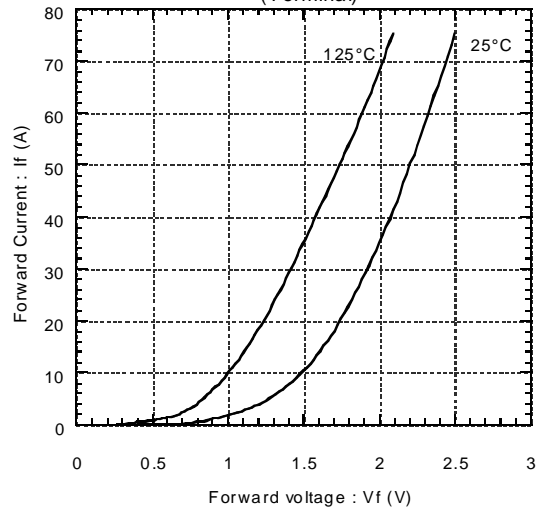

Switching Loss vs. Collector Current
 $E_{dc}=600V, V_{cc}=15V, T_j=25^\circ C$

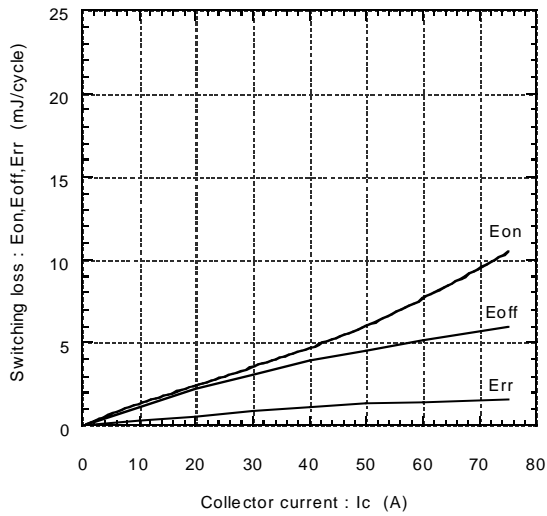

Switching Loss vs. Collector Current
 $E_{dc}=600V, V_{cc}=15V, T_j=125^\circ C$

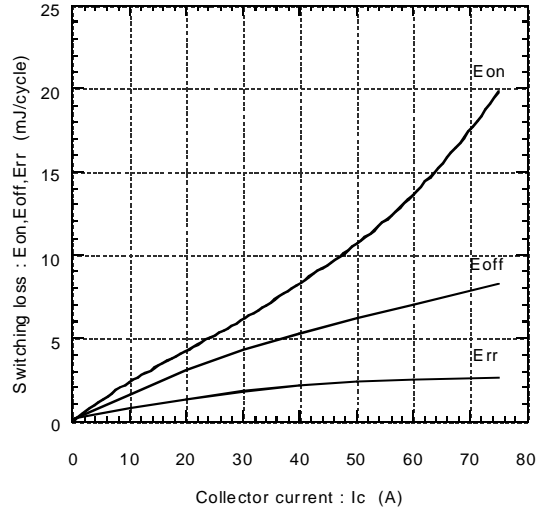

Reversed biased safe operating area
 $V_{cc}=15V, T_j \le 125^\circ C$

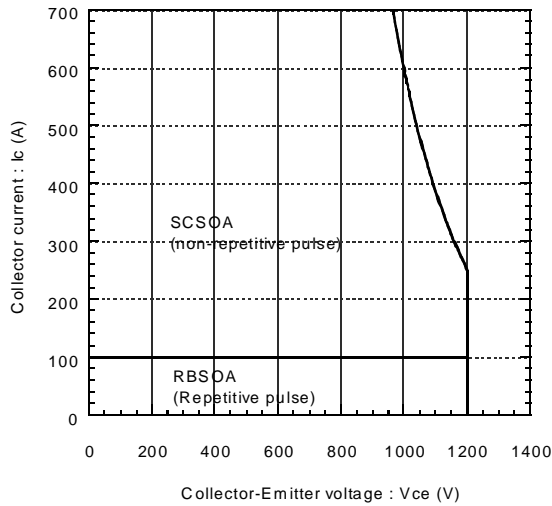

Transient thermal resistance

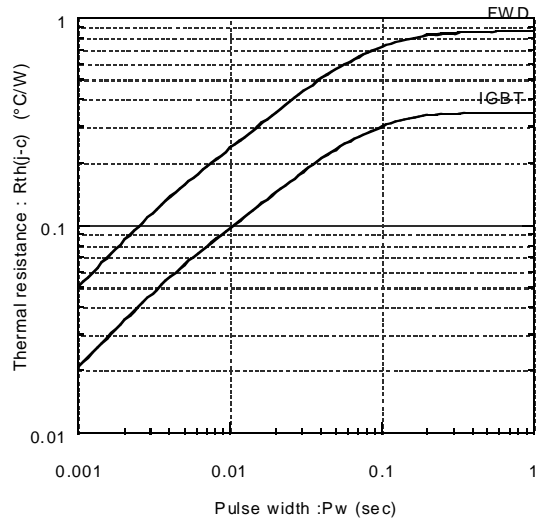

Power derating for IGBT
 (per device)

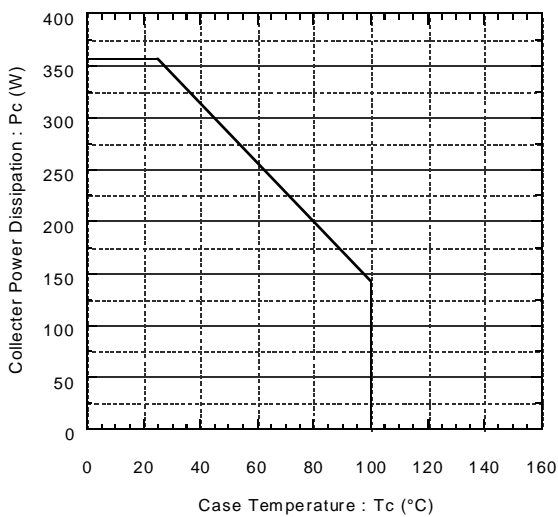

Power derating for FWD
 (per device)

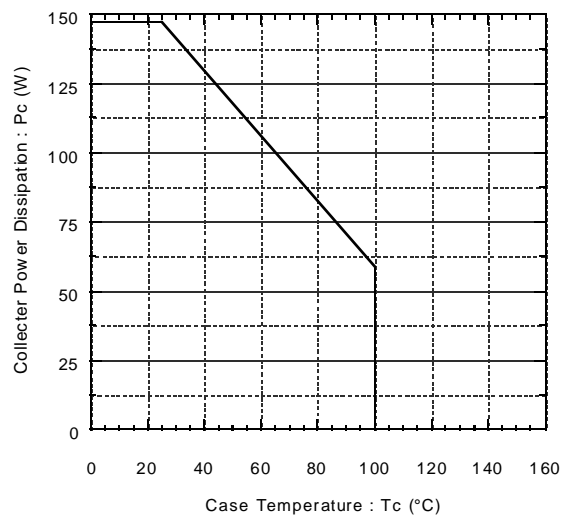

Switching time vs. Collector current
 $E_{dc}=600V, V_{cc}=15V, T_j=25^\circ C$

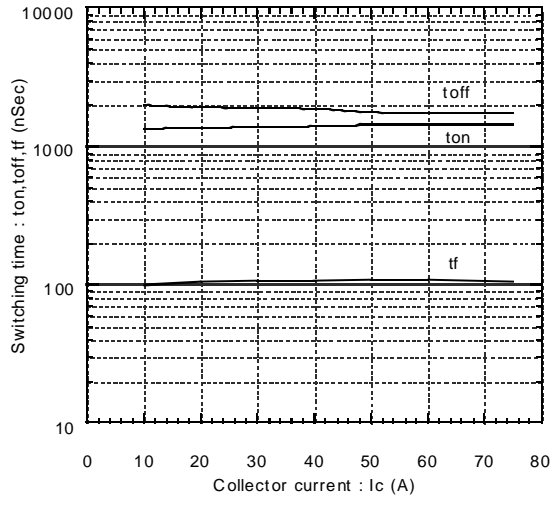

Switching time vs. Collector current
 $E_{dc}=600V, V_{cc}=15V, T_j=125^\circ C$

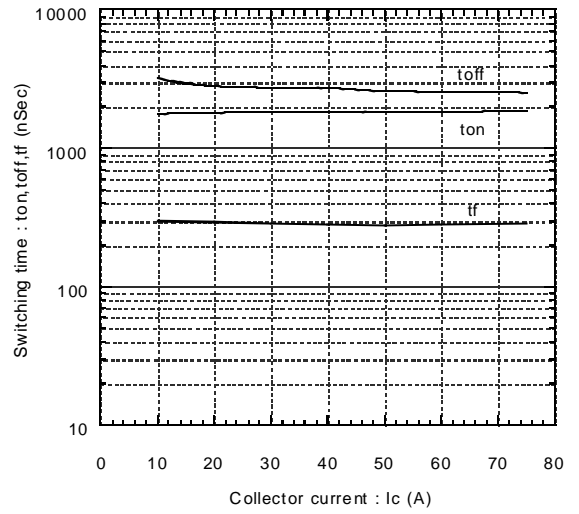

Reverse recovery characteristics
 t_{rr}, I_{rr} vs. I_F

