

6MBP50RTB060

IPM-R3 series

600V / 50A 6 in one-package

Features

- Temperature protection provided by directly detecting the junction temperature of the IGBTs
- Low power loss and soft switching
- High performance and high reliability IGBT with overheating protection
- Higher reliability because of a big decrease in number of parts in built-in control circuit

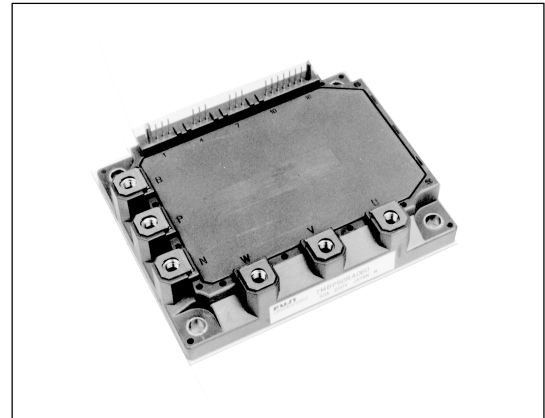

Maximum ratings and characteristics

- Absolute maximum ratings(at Tc=25°C unless otherwise specified)

| Item | Symbol | Rating | | Unit | |
|--|------------------------|--------------------|----------------------|------|---|
| | | Min. | Max. | | |
| DC bus voltage | V _{DC} | 0 | 450 | V | |
| DC bus voltage (surge) | V _{DC(surge)} | 0 | 500 | V | |
| DC bus voltage (short operating) | V _{SC} | 200 | 400 | V | |
| Collector-Emitter voltage | V _{CES} *1 | 0 | 600 | V | |
| INV Collector current | DC | I _C | - | 50 | A |
| | 1ms | I _{CP} | - | 100 | A |
| | Duty=76.1% | -I _C *2 | - | 50 | A |
| Collector power dissipation | One transistor | P _C *3 | - | 144 | W |
| Junction temperature | T _j | - | 150 | °C | |
| Input voltage of power supply for Pre-Driver | V _{CC} *4 | -0.5 | 20 | V | |
| Input signal voltage | V _{in} *5 | -0.5 | V _{CC} +0.5 | V | |
| Input signal current | I _{in} | - | 3 | mA | |
| Alarm signal voltage | V _{ALM} *6 | -0.5 | V _{CC} | V | |
| Alarm signal current | I _{ALM} *7 | - | 20 | mA | |
| Storage temperature | T _{stg} | -40 | 125 | °C | |
| Operating case temperature | T _{op} | -20 | 100 | °C | |
| Isolating voltage (Case-Terminal) | V _{iso} *8 | - | AC2.5 | kV | |
| Screw torque | Mounting (M5) | - | 3.5 *9 | N·m | |
| | Terminal (M5) | - | 3.5 *9 | N·m | |

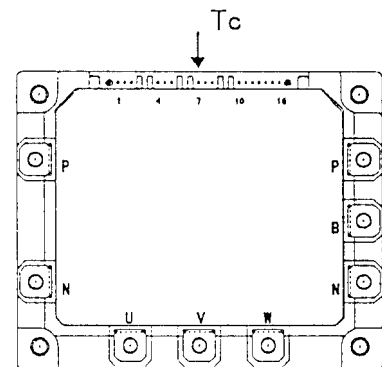

Fig.1 Measurement of case temperature

*1 : V_{CES} shall be applied to the input voltage between terminal P and U or V or W, N and U or V or W.

*2 : $125^{\circ}\text{C}/\text{FWD } R_{th(j-c)}/(I_c \times V_F \text{ MAX})=125/1.263/(50 \times 2.6) \times 100=76.1\%$

*3 : $P_c=125^{\circ}\text{C}/\text{IGBT } R_{th(j-c)}=125/0.87=144\text{W}$ [Inverter]

*4 : V_{CC} shall be applied to the input voltage between terminal No. 3 and 1, 6 and 4, 9 and 7, 11 and 10.

*5 : V_{in} shall be applied to the input voltage between terminal No. 2 and 1, 5 and 4, 8 and 7, 13,14,15 and 10.

*6 : V_{ALM} shall be applied to the voltage between terminal No. 16 and 10.

*7 : I_{ALM} shall be applied to the input current to terminal No. 16.

*8 : 50Hz/60Hz sine wave 1 minute.

*9 : Recommendable Value : 2.5 to 3.0 N·m

● **Electrical characteristics** (at $T_c=T_j=25^\circ\text{C}$, $V_{cc}=15\text{V}$ unless otherwise specified.)

Main circuit

| Item | | Symbol | Condition | Min. | Typ. | Max. | Unit | |
|--|---------------------------------------|---------------|--|----------|------|------|---------------|---|
| INV | Collector current at off signal input | I_{CES} | $V_{CE}=600\text{V}$ V_{in} terminal open. | - | - | 1.0 | mA | |
| | Collector-Emitter saturation voltage | $V_{CE(sat)}$ | $I_c=50\text{A}$ | Terminal | - | - | 2.5 | V |
| | | | | Chip | - | 2.0 | - | |
| | Forward voltage of FWD | V_F | $-I_c=50\text{A}$ | Terminal | - | - | 2.6 | V |
| Chip | | | | - | 1.6 | - | | |
| Turn-on time | | t_{on} | $V_{DC}=300\text{V}, T_j=125^\circ\text{C}$ | 1.2 | - | - | μs | |
| Turn-off time | | t_{off} | $I_c=50\text{A}$ Fig.1, Fig.6 | - | - | 3.6 | | |
| Reverse recovery time | | t_{rr} | $V_{DC}=300\text{V}, I_c=50\text{A}$ Fig.1, Fig.6 | - | - | 0.3 | | |
| Maximum Avalanche Energy (A non-repetition) | | P_{AV} | Internal wiring inductance=50nH Main circuit wiring inductance=54nH | 30 | - | - | mJ | |

● **Control circuit**

| Item | Symbol | Condition | Min. | Typ. | Max. | Unit |
|--|--------------|--|------|------|------|------|
| Supply current of P-line side pre-driver(one unit) | I_{ccp} | Switching Frequency : 0 to 15kHz $T_c=-20$ to 125°C Fig.7 | - | - | 18 | mA |
| Supply current of N-line side pre-driver | I_{ccn} | | - | - | 65 | mA |
| Input signal threshold voltage (on/off) | $V_{in(th)}$ | ON | 1.00 | 1.35 | 1.70 | V |
| | | OFF | 1.25 | 1.60 | 1.95 | V |
| Input zener voltage | V_z | $R_{in}=20\text{k ohm}$ | - | 8.0 | - | V |
| Alarm signal hold time | t_{ALM} | $T_c=-20^\circ\text{C}$ Fig.2 | 1.1 | - | - | ms |
| | | $T_c=25^\circ\text{C}$ Fig.2 | - | 2.0 | - | ms |
| | | $T_c=125^\circ\text{C}$ Fig.2 | - | - | 4.0 | ms |
| Limiting resistor for alarm | R_{ALM} | | 1425 | 1500 | 1575 | ohm |

● **Protection Section** ($V_{cc}=15\text{V}$)

| Item | Symbol | Condition | Min. | Typ. | Max. | Unit |
|---|-----------|--|------|------|------|------------------|
| Over Current Protection Level of Inverter circuit | I_{oc} | $T_j=125^\circ\text{C}$ | 75 | - | - | A |
| Over Current Protection Delay time | t_{doc} | $T_j=125^\circ\text{C}$ | - | 5 | - | μs |
| SC Protection Delay time | t_{sc} | $T_j=125^\circ\text{C}$ Fig.4 | - | - | 8 | μs |
| IGBT Chip Over Heating | T_{jOH} | surface of IGBT chips | 150 | - | - | $^\circ\text{C}$ |
| Over Heating Protection Hysteresis | T_{jH} | $V_{DC}=0\text{V}, I_c=0\text{A}$, Case temperature | - | 20 | - | $^\circ\text{C}$ |
| Over Heating Protection Temperature Level | T_{COH} | | 110 | - | 125 | $^\circ\text{C}$ |
| Over Heating Protection Hysteresis | T_{CH} | | - | 20 | - | |
| Under Voltage Protection Level | V_{UV} | | 11.0 | - | 12.5 | V |
| Under Voltage Protection Hysteresis | V_H | | 0.2 | 0.5 | - | |

● **Thermal characteristics**($T_c=25^\circ\text{C}$)

| Item | Symbol | | Min. | Typ. | Max. | Unit |
|--|----------|------|------|------|-------|--------------------|
| Junction to Case thermal resistance | INV | IGBT | - | - | 0.87 | $^\circ\text{C/W}$ |
| | | FWD | - | - | 1.263 | $^\circ\text{C/W}$ |
| Case to fin thermal resistance with compound | Rth(c-f) | | - | 0.05 | - | $^\circ\text{C/W}$ |

● **Noise Immunity** ($V_{DC}=300\text{V}$, $V_{cc}=15\text{V}$, Test Circuit Fig.5)

| Item | Condition | Min. | Typ. | Max. | Unit |
|-------------------------------|--|-----------|------|------|------|
| Common mode rectangular noise | Pulse width $1\mu\text{s}$, polarity \pm , 10minuets Judge : no over-current, no miss operating | ± 2.0 | - | - | kV |
| Common mode lightning surge | Rise time $1.2\mu\text{s}$, Fall time $50\mu\text{s}$ Interval 20s, 10 times Judge : no over-current, no miss operating | ± 5.0 | - | - | kV |

● **Recommendable value**

| Item | Symbol | Min. | Typ. | Max. | Unit |
|--|----------|------|------|------|------|
| DC Bus Voltage | V_{DC} | - | - | 400 | V |
| Operating Supply Voltage of Pre-Driver | V_{cc} | 13.5 | 15.0 | 16.5 | V |
| Screw torque (M5) | - | 2.5 | - | 3.0 | Nm |

● **Weight**

| Item | Symbol | Min. | Typ. | Max. | Unit |
|--------|--------|------|------|------|------|
| Weight | W_t | - | 450 | - | g |

*9 : (For 1 device, Case is under the device)

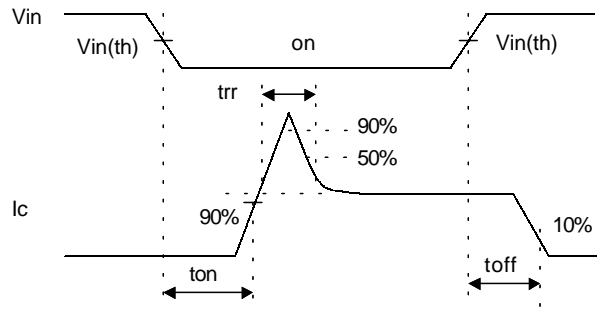
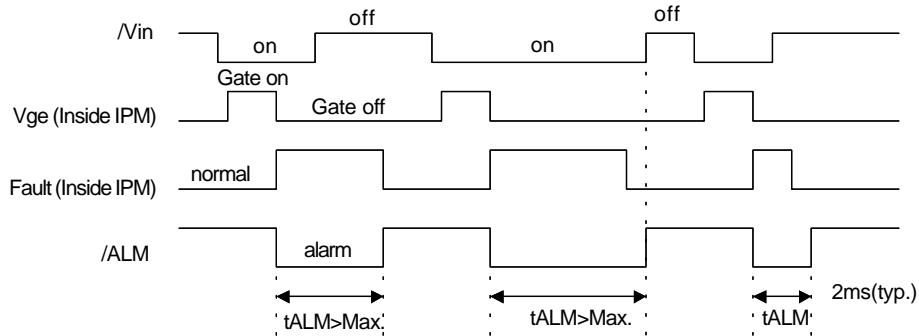

Figure 1. Switching Time Waveform Definitions



Fault : Over-current, Over-heat or Under-voltage

Figure 2. Input / Output Timing Diagram

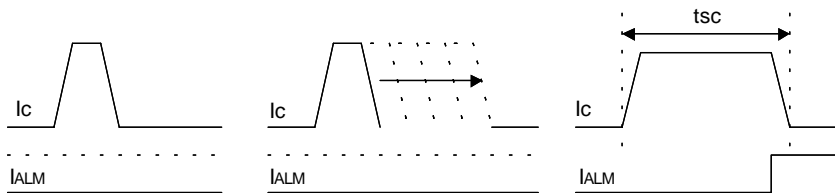

Figure. 4 Definition of tsc

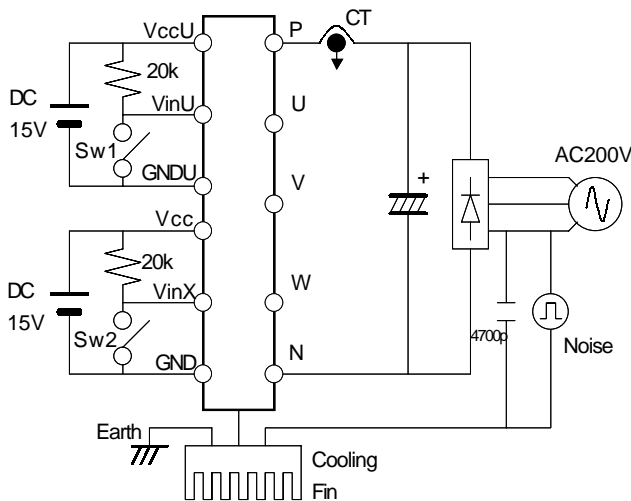

Figure 5. Noise Test Circuit

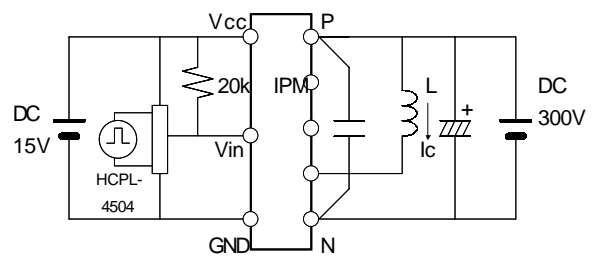

Figure 6. Switching Characteristics Test Circuit

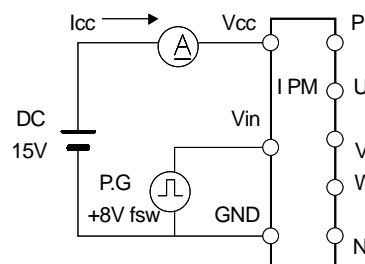
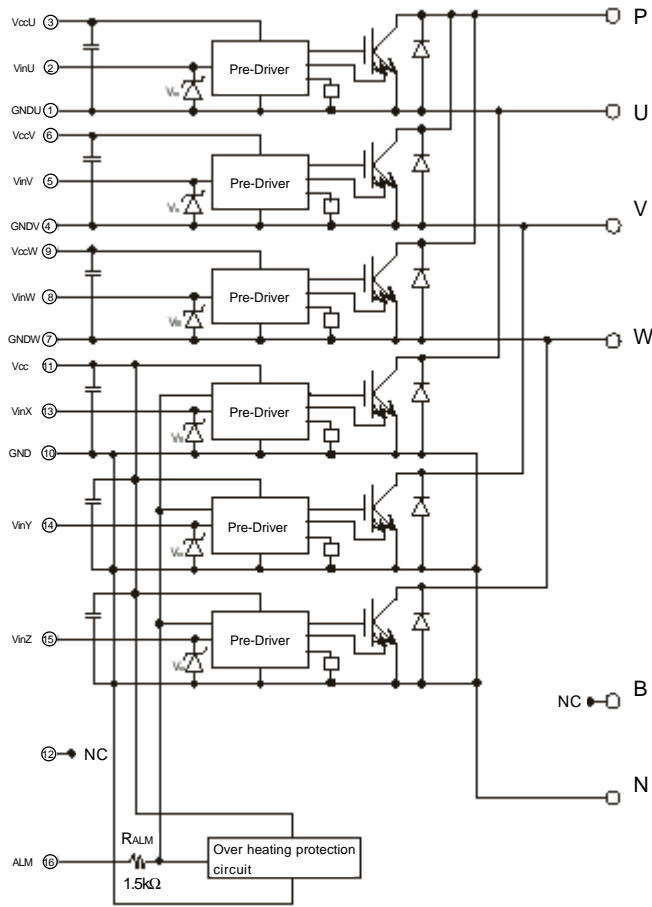

Figure 7. Icc Test Circuit

Block diagram



- Pre-driver include following functions
- ① Amplifier for drive
 - ② Short circuit protection
 - ③ Under voltage lockout circuit
 - ④ Over current protection
 - ⑤ IGBT chip over heating protection

Outline drawings, mm

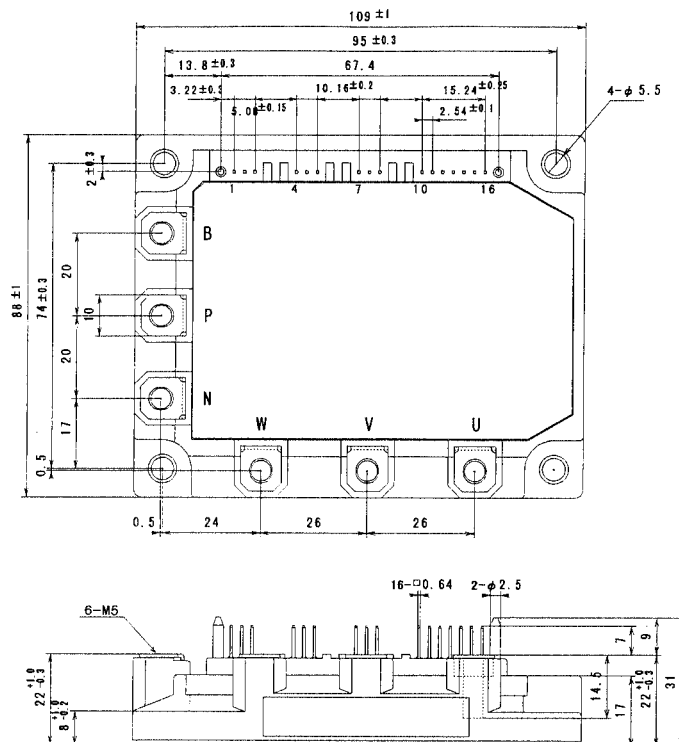

Mass : 450g

Characteristics

Control circuit characteristics (Representative)

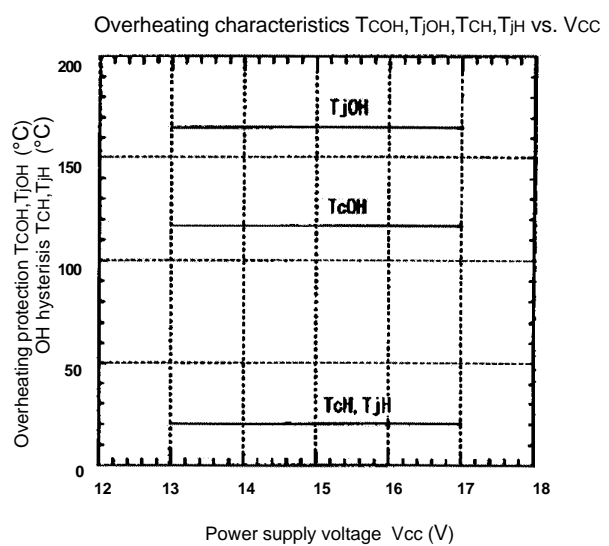
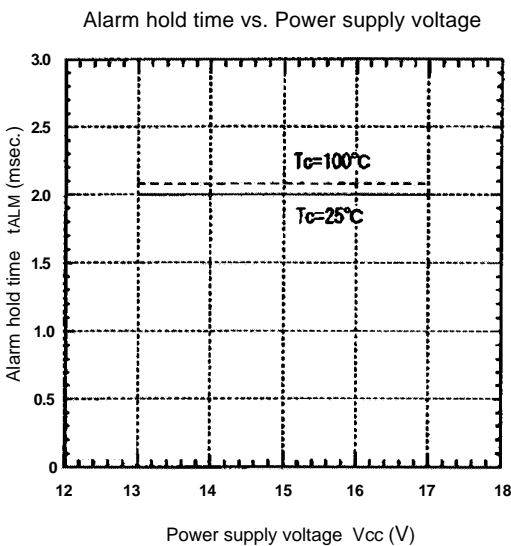
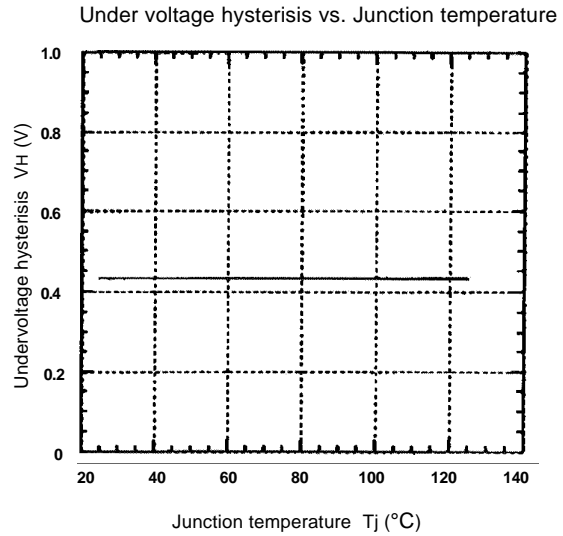
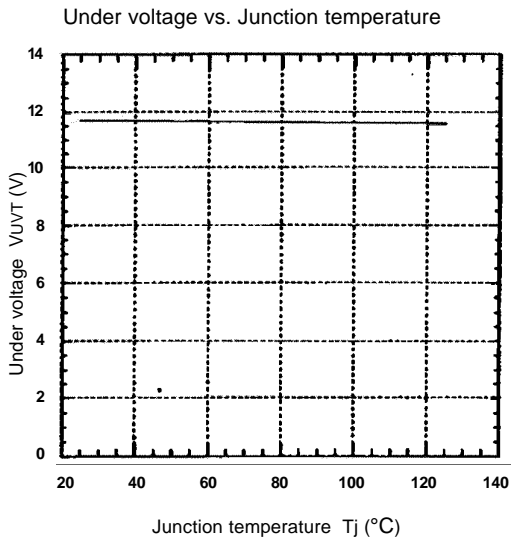
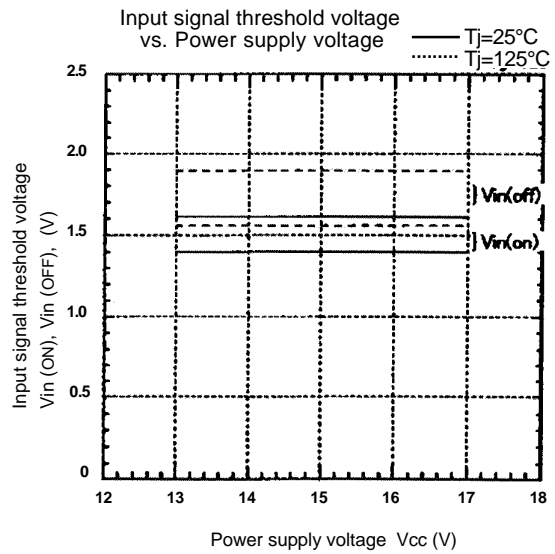
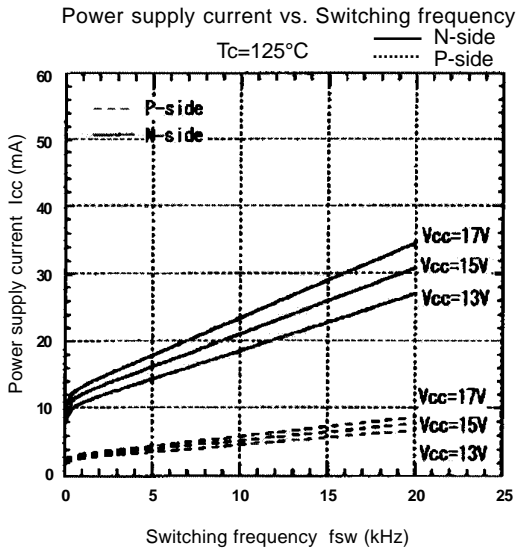

● Main circuit characteristics (Representative)

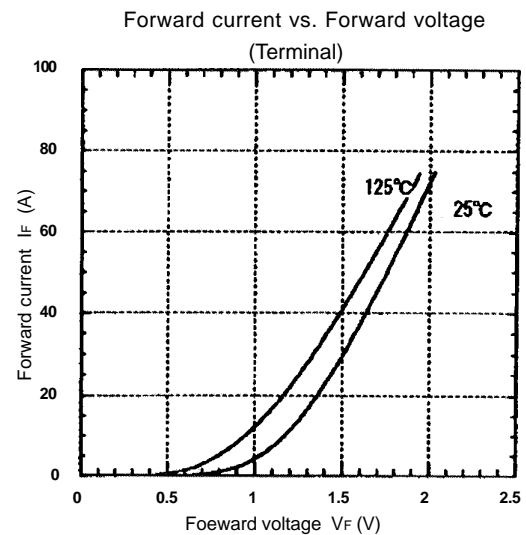
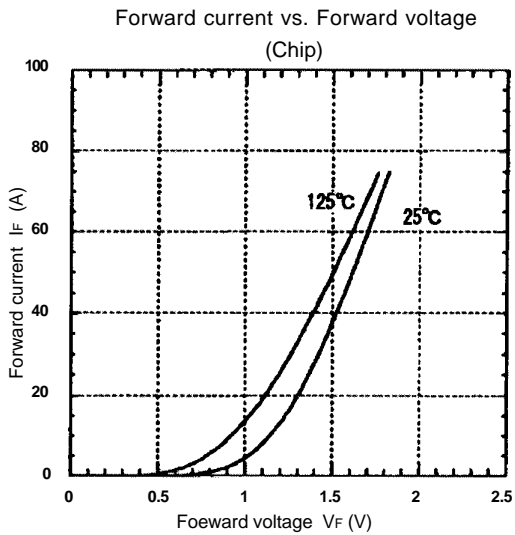
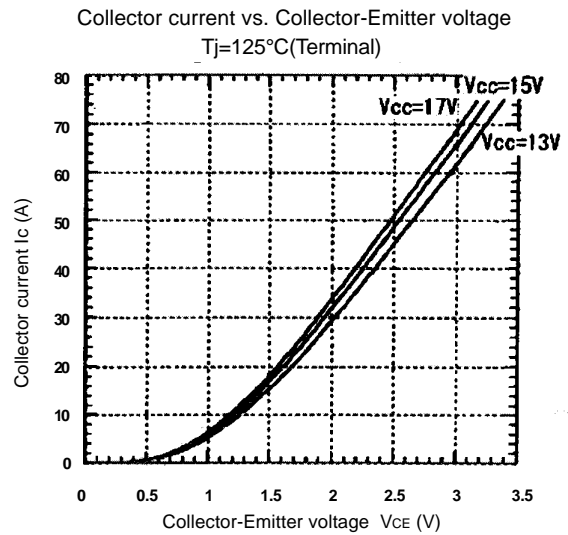
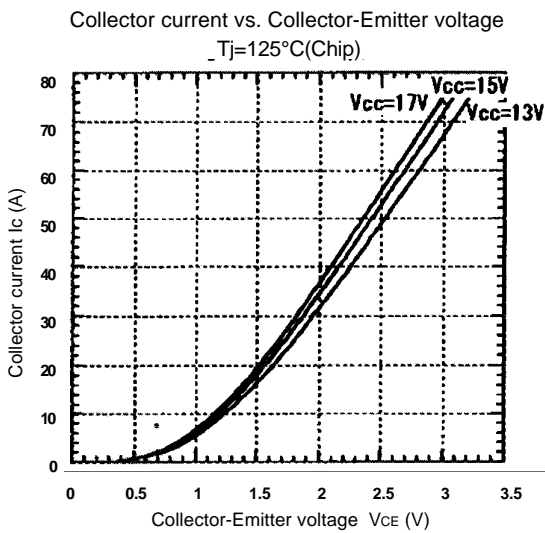
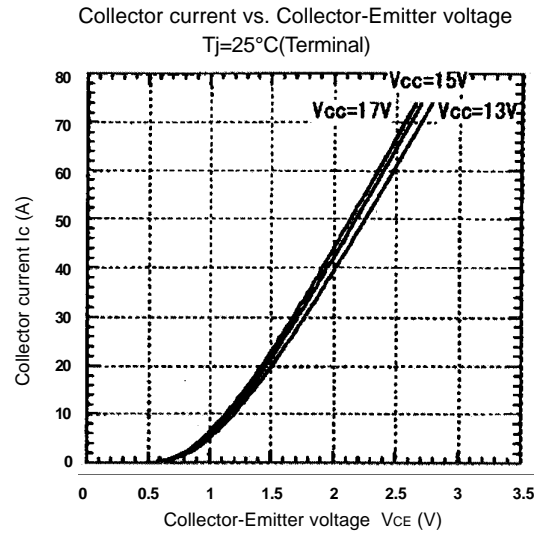
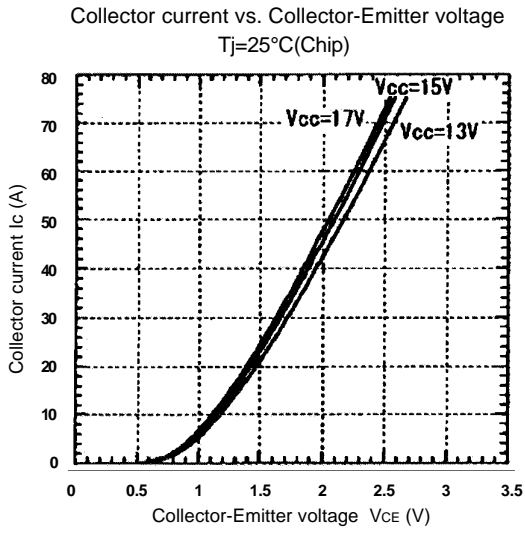

Switching Loss vs. Collector current
 $E_{dc}=300V, V_{cc}=15V, T_j=25^\circ C$

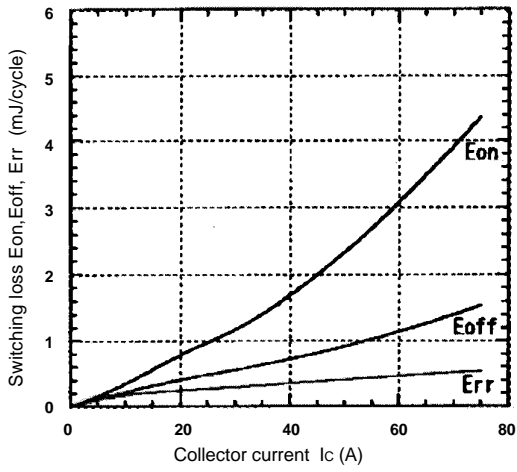

Switching Loss vs. Collector current
 $E_{dc}=300V, V_{cc}=15V, T_j=125^\circ C$

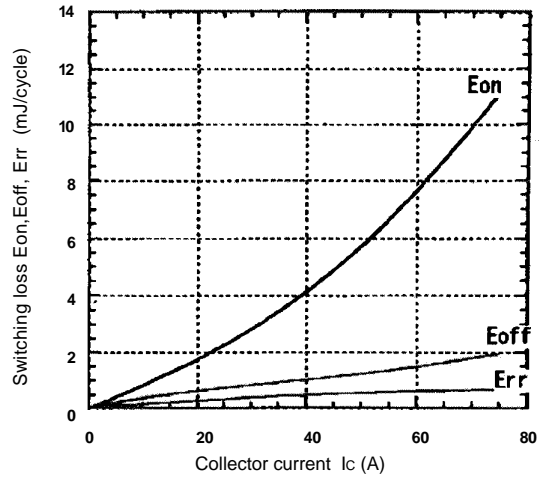

Reverse biased safe operating area
 $V_{cc}=15V, T_j \le 125^\circ C$

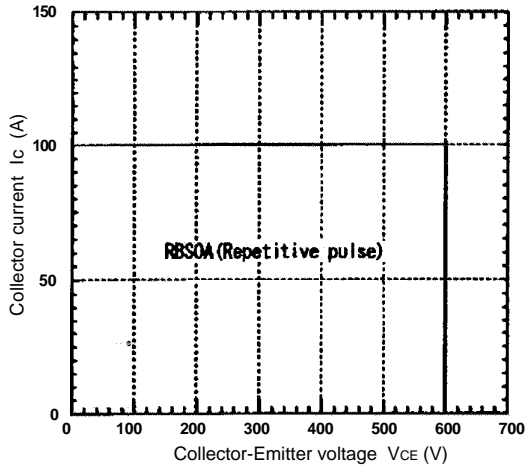

Transient thermal resistance

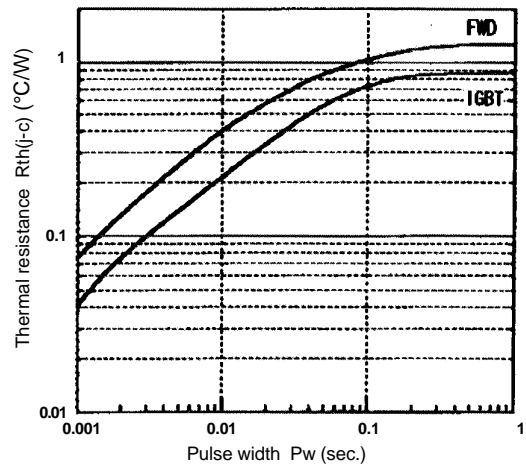

Power derating for IGBT (per device)

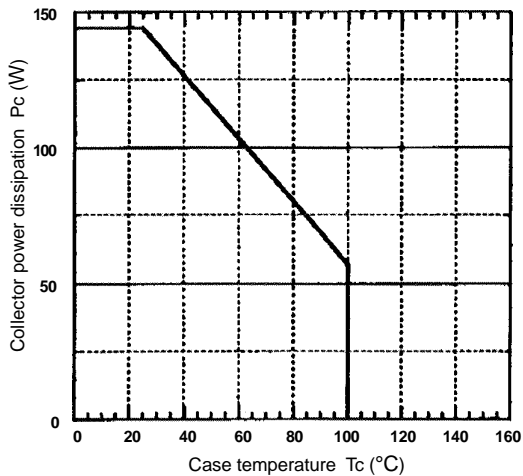

Power derating for FWD (per device)

