

7MBP100RA120

IGBT-IPM R series

1200V / 100A 7 in one-package

Features

- Temperature protection provided by directly detecting the junction temperature of the IGBTs
- Low power loss and soft switching
- High performance and high reliability IGBT with overheating protection
- Higher reliability because of a big decrease in number of parts in built-in control circuit

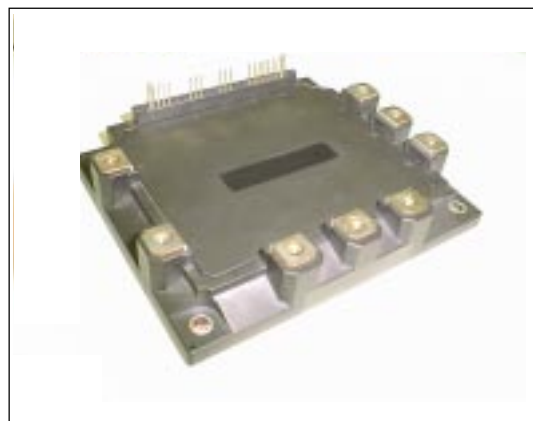

Maximum ratings and characteristics

- Absolute maximum ratings(at $T_c=25^\circ\text{C}$ unless otherwise specified)

| Item | Symbol | Rating | | Unit | | | |
|--|-----------------------------|-------------------|----------|------------------|-----|-----|---|
| | | Min. | Max. | | | | |
| DC bus voltage | V_{DC} | 0 | 900 | V | | | |
| DC bus voltage (surge) | $V_{DC(surge)}$ | 0 | 1000 | V | | | |
| DC bus voltage (short operating) | V_{SC} | 200 | 800 | V | | | |
| Collector-Emitter voltage | V_{CES} | 0 | 1200 | V | | | |
| DB Reverse voltage | V_R | - | 1200 | V | | | |
| INV | Collector current | DC | I_c | - | 100 | A | |
| | | 1ms | I_{CP} | - | 200 | A | |
| | | DC | $-I_c$ | - | 100 | A | |
| DB | Collector power dissipation | One transistor | P_C | - | 735 | W | |
| | | Collector current | DC | I_c | - | 50 | A |
| | | | 1ms | I_{CP} | - | 100 | A |
| DB | Forward current of Diode | I_F | - | 50 | A | | |
| | Collector power dissipation | One transistor | P_C | - | 400 | W | |
| Junction temperature | T_j | - | 150 | $^\circ\text{C}$ | | | |
| Input voltage of power supply for Pre-Driver | V_{CC}^*1 | 0 | 20 | V | | | |
| Input signal voltage | V_{in}^*2 | 0 | V_Z | V | | | |
| Input signal current | I_{in} | - | 1 | mA | | | |
| Alarm signal voltage | V_{ALM}^*3 | 0 | V_{CC} | V | | | |
| Alarm signal current | I_{ALM}^*4 | - | 15 | mA | | | |
| Storage temperature | T_{stg} | -40 | 125 | $^\circ\text{C}$ | | | |
| Operating case temperature | T_{op} | -20 | 100 | $^\circ\text{C}$ | | | |
| Isolating voltage (Case-Terminal) | V_{iso}^*5 | - | AC2.5 | kV | | | |
| Screw torque | Mounting (M5) | - | 3.5^*6 | N·m | | | |
| | Terminal (M5) | - | 3.5^*6 | N·m | | | |

*1 Apply V_{CC} between terminal No. 3 and 1, 6 and 4, 9 and 7, 11 and 10.

*2 Apply V_{in} between terminal No. 2 and 1, 5 and 4, 8 and 7, 12,13,14,15 and 10.

*3 Apply V_{ALM} between terminal No. 16 and 10.

*4 Apply I_{ALM} to terminal No. 16.

*5 50Hz/60Hz sine wave 1 minute.

*6 Recommendable Value : 2.5 to 3.0 N·m

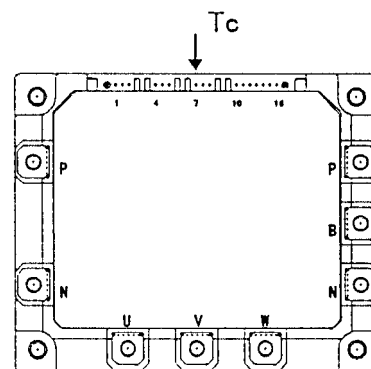

Fig.1 Measurement of case temperature

- Electrical characteristics of power circuit (at $T_c=T_j=25^\circ\text{C}$, $V_{CC}=15\text{V}$)

| Item | Symbol | Condition | Min. | Typ. | Max. | Unit | |
|------|---------------------------------------|---------------|---|------|------|------|----|
| INV | Collector current at off signal input | I_{CES} | $V_{CE}=1200\text{V}$ input terminal open | - | - | 1.0 | mA |
| | Collector-Emitter saturation voltage | $V_{CE(sat)}$ | $I_c=100\text{A}$ | - | - | 2.6 | V |
| | Forward voltage of FWD | V_F | $-I_c=100\text{A}$ | - | - | 3.0 | V |
| DB | Collector current at off signal input | I_{CES} | $V_{CE}=1200\text{V}$ input terminal open | - | - | 1.0 | mA |
| | Collector-Emitter saturation voltage | $V_{CE(sat)}$ | $I_c=50\text{A}$ | - | - | 2.6 | V |
| | Forward voltage of Diode | V_F | $-I_c=50\text{A}$ | - | - | 3.3 | V |

● Electrical characteristics of control circuit(at Tc=Tj=25°C, Vcc=15V)

| Item | Symbol | Condition | Min. | Typ. | Max. | Unit | |
|--|---------------------|--|-----------------------|------|------|------|---|
| Power supply current of P-line side Pre-driver(one unit) | I _{ccp} | fsw=0 to 15kHz Tc=-20 to 100°C *7 | 3 | - | 18 | mA | |
| Power supply current of N-line side three Pre-driver | I _{ccn} | fsw=0 to 15kHz Tc=-20 to 100°C *7 | 10 | - | 65 | mA | |
| Input signal threshold voltage (on/off) | V _{in(th)} | ON | 1.00 | 1.35 | 1.70 | V | |
| | | OFF | 1.70 | 2.05 | 2.40 | V | |
| Input zener voltage | V _z | R _{in} =20k ohm | - | 8.0 | - | V | |
| Over heating protection temperature level | T _{COH} | VDC=0V, I _c =0A, Case temperature Fig.1 | 110 | - | 125 | °C | |
| Hysteresis | T _{CH} | | - | 20 | - | °C | |
| IGBT chips over heating protection temperature level | T _{JOH} | surface of IGBT chips | 150 | - | - | °C | |
| Hysteresis | T _{JH} | | - | 20 | - | °C | |
| Collector current protection level | INV | I _{oc} | T _j =125°C | 150 | - | - | A |
| | DB | I _{oc} | T _j =125°C | 75 | - | - | A |
| Over current protection delay time | t _{DOC} | T _j =25°C Fig.2 | - | 10 | - | μs | |
| Under voltage protection level | V _{UV} | | 11.0 | - | 12.5 | V | |
| Hysteresis | V _H | | 0.2 | - | - | V | |
| Alarm signal hold time | t _{ALM} | | 1.5 | 2 | - | ms | |
| SC protection delay time | t _{SC} | T _j =25°C Fig.3 | - | - | 12 | μs | |
| Limiting resistor for alarm | R _{ALM} | | 1425 | 1500 | 1575 | ohm | |

*7 Switching frequency of IPM

● Dynamic characteristics(at Tc=Tj=125°C, Vcc=15V)

| Item | Symbol | Condition | Min. | Typ. | Max. | Unit |
|-----------------------|-----------------|--------------------------------|------|------|------|------|
| Switching time (IGBT) | ton | I _C =100A, VDC=600V | 0.3 | - | - | μs |
| | toff | | - | - | 3.6 | μs |
| Switching time (FWD) | t _{rr} | I _F =100A, VDC=600V | - | - | 0.4 | μs |

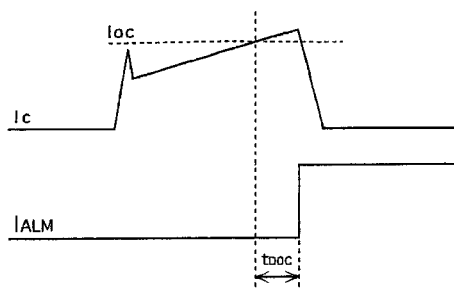

Fig.2 Definition of OC delay time

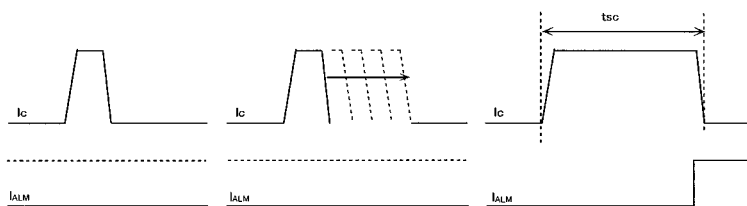

Fig.3 Definition of tsc

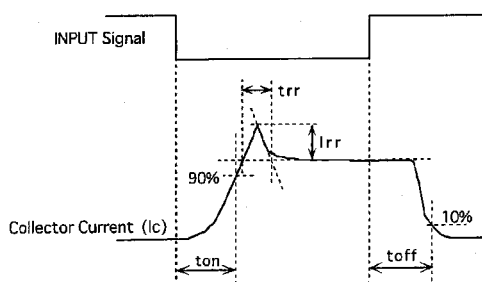

Fig.4 Definition of switching time

● Thermal characteristics(Tc=25°C)

| Item | Symbol | Typ. | Max. | Unit | | |
|--|----------------------|------|----------------------|------|------|------|
| Junction to Case thermal resistance | INV | IGBT | R _{th(j-c)} | - | 0.17 | °C/W |
| | | FWD | R _{th(j-c)} | - | 0.36 | °C/W |
| | DB | IGBT | R _{th(j-c)} | - | 0.31 | °C/W |
| Case to fin thermal resistance with compound | R _{th(c-f)} | 0.05 | - | °C/W | | |

● Recommendable value

| Item | Symbol | Min. | Typ. | Max. | Unit | |
|--|-----------------|------|------|------|------|-----|
| DC bus voltage | V _{DC} | 200 | - | 800 | V | |
| Operating power supply voltage range of Pre-driver | V _{CC} | 13.5 | 15 | 16.5 | V | |
| Switching frequency of IPM | fsw | 1 | - | 20 | kHz | |
| Screw torque | Mounting (M5) | - | 2.5 | - | 3.0 | N·m |
| | Terminal (M5) | - | 2.5 | - | 3.0 | N·m |

Block diagram

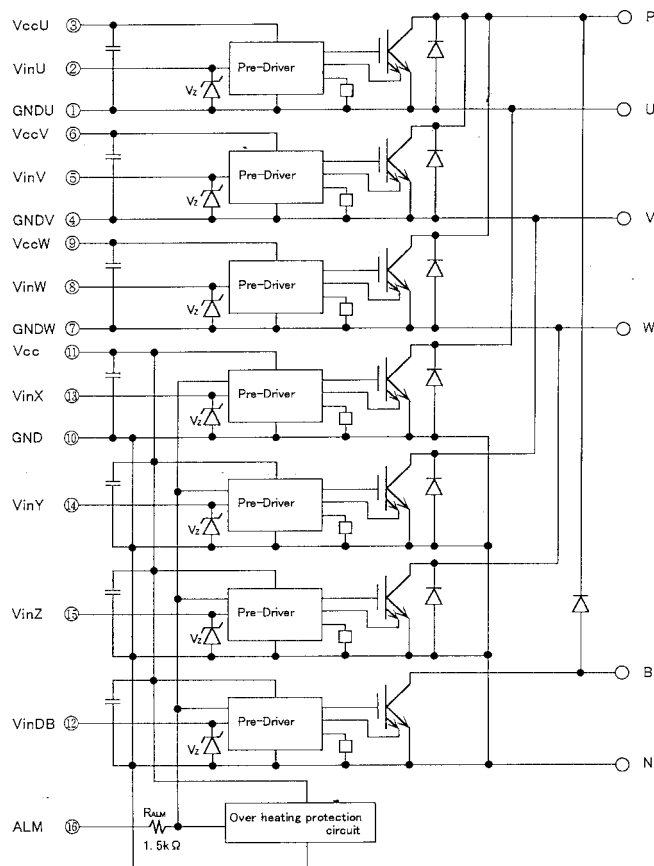

Pre-drivers include following functions

- a) Amplifier for driver
- b) Short circuit protection
- c) Undervoltage lockout circuit
- d) Over current protection
- e) IGBT chip over heating protection

Outline drawings, mm

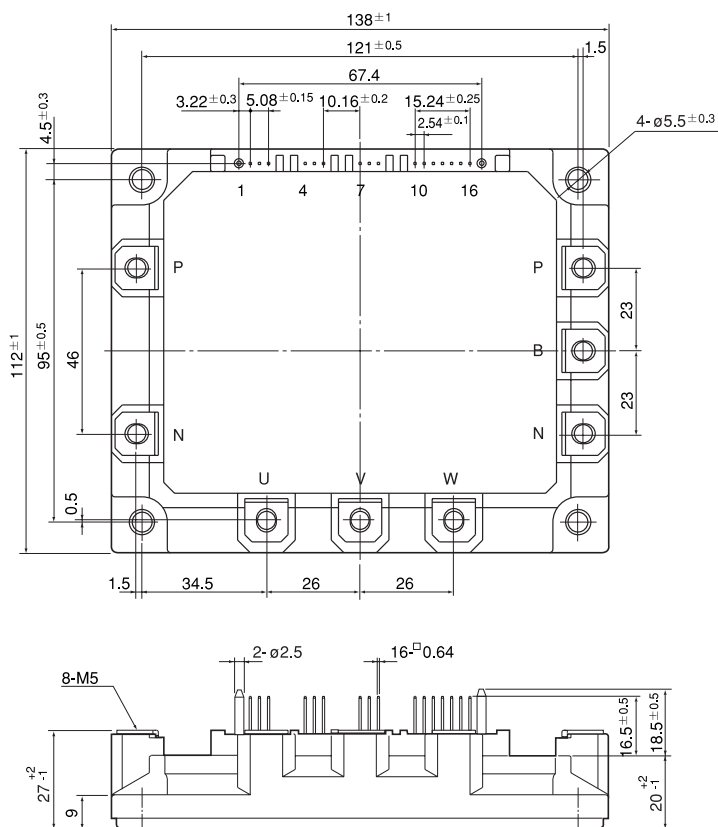

Mass : 920g

Characteristics (Representative)

● control circuit

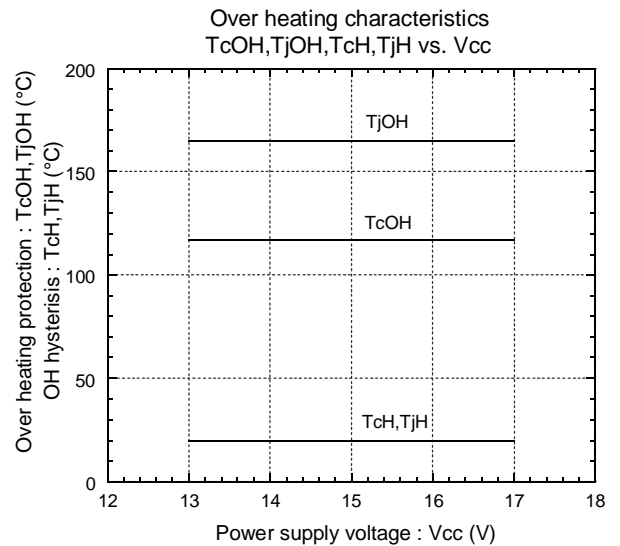
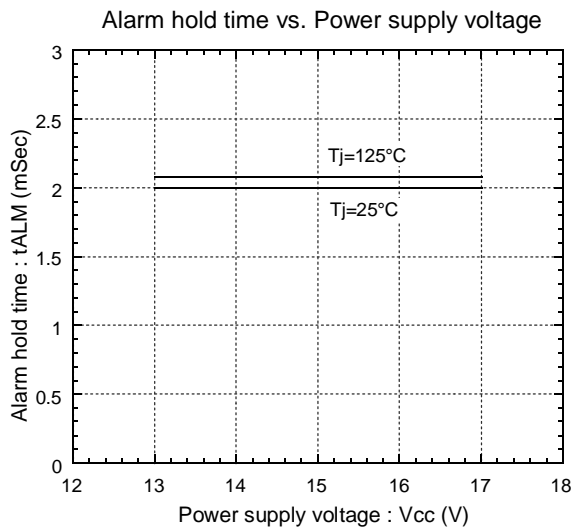
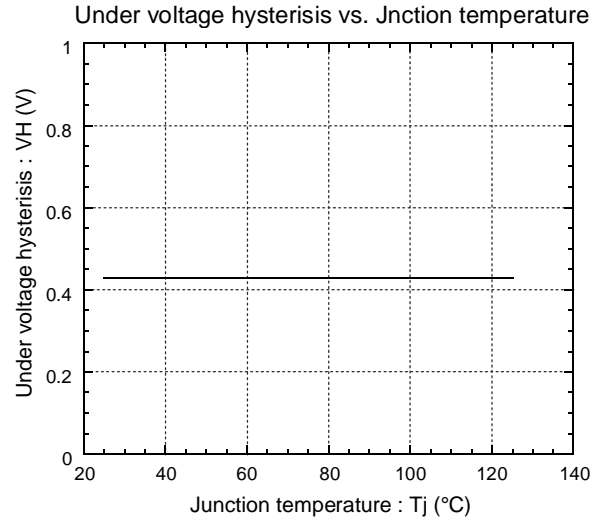
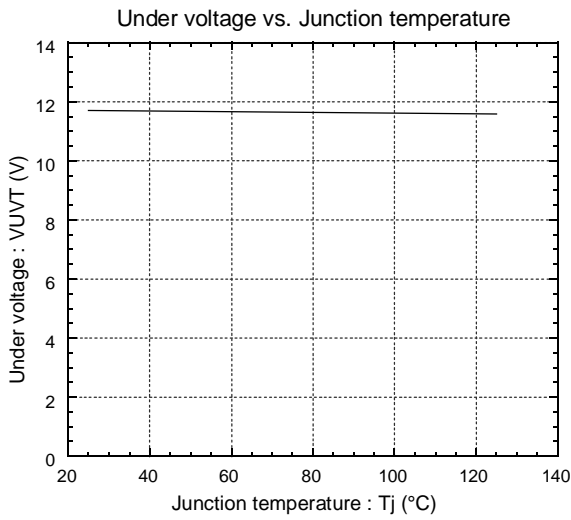
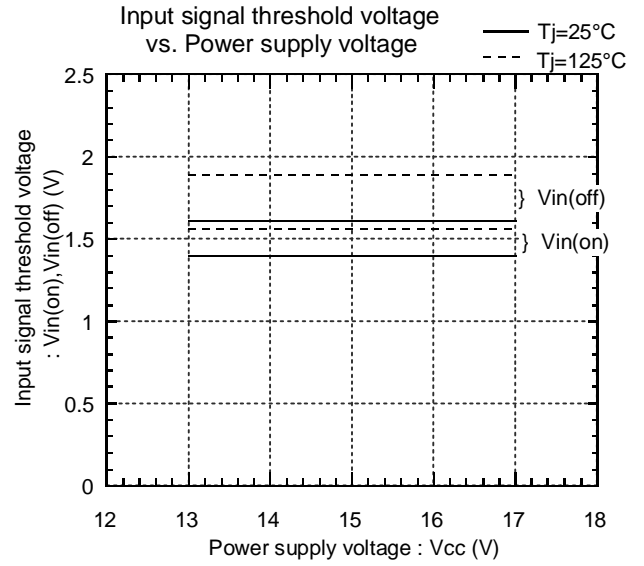
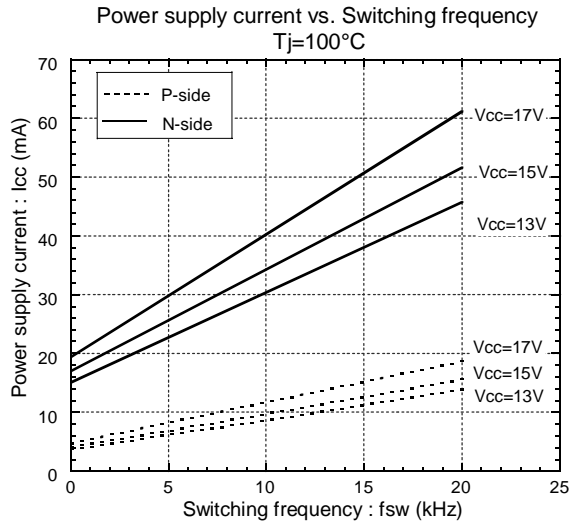

● Inverter

Collector current vs. Collector-Emmitter voltage
T_j=25°C

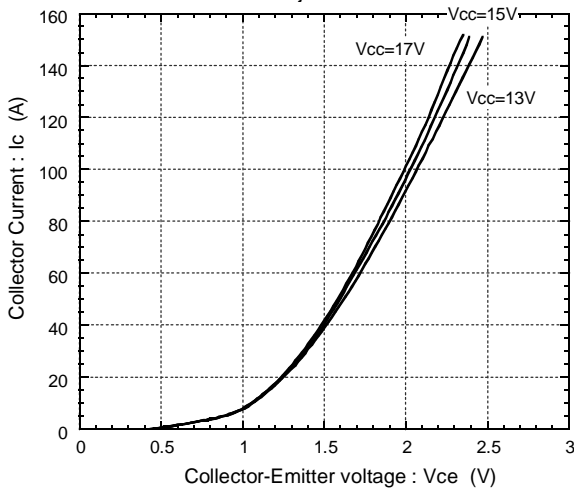

Collector current vs. Collector-Emmitter voltage
T_j=125°C

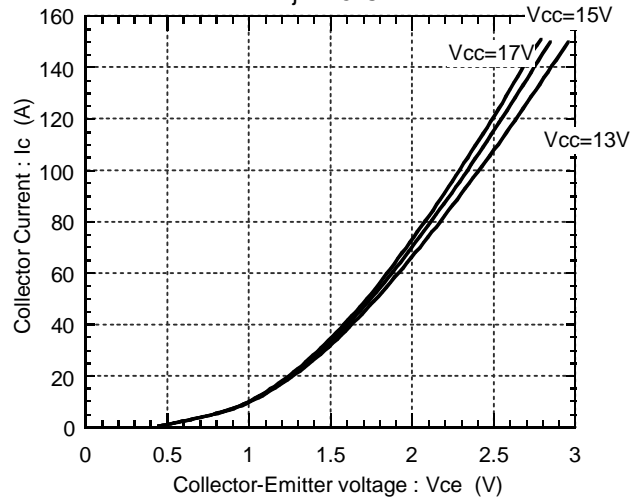

Switching time vs. Collector current
E_{dc}=600V, V_{cc}=15V, T_j=25°C

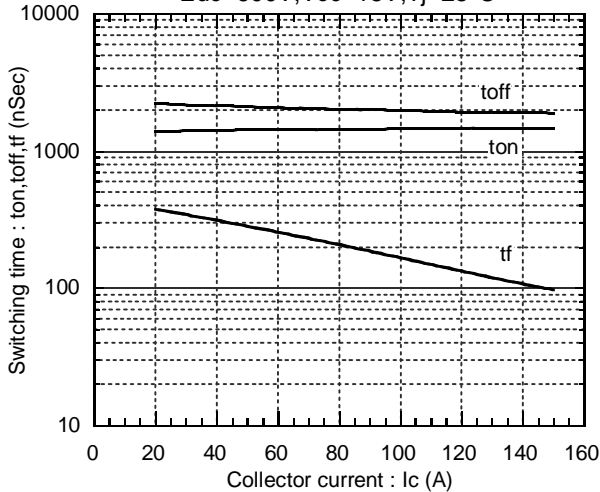

Switching time vs. Collector current
E_{dc}=600V, V_{cc}=15V, T_j=125°C

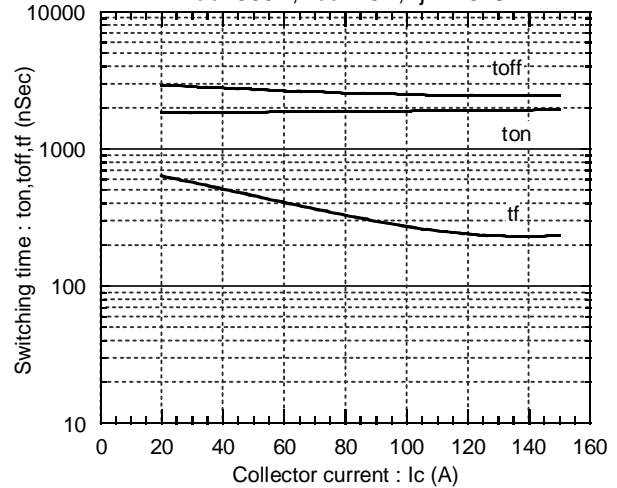

Forward current vs. Forward voltage

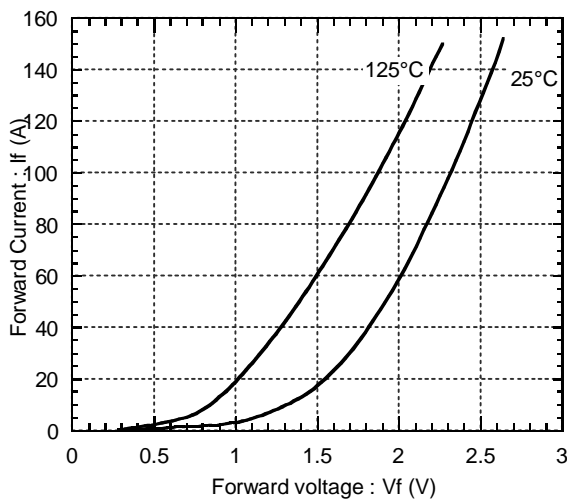

Reverse recovery characteristics
trr, Irr vs. IF

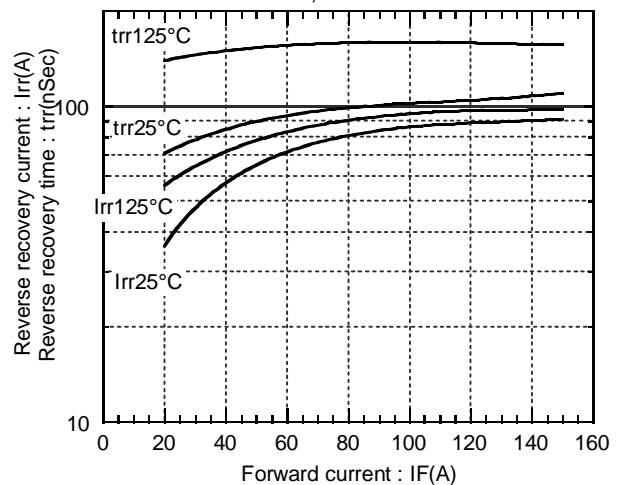

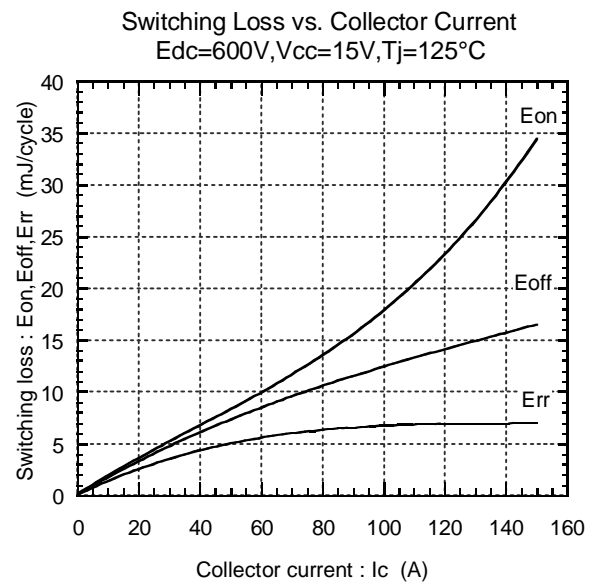
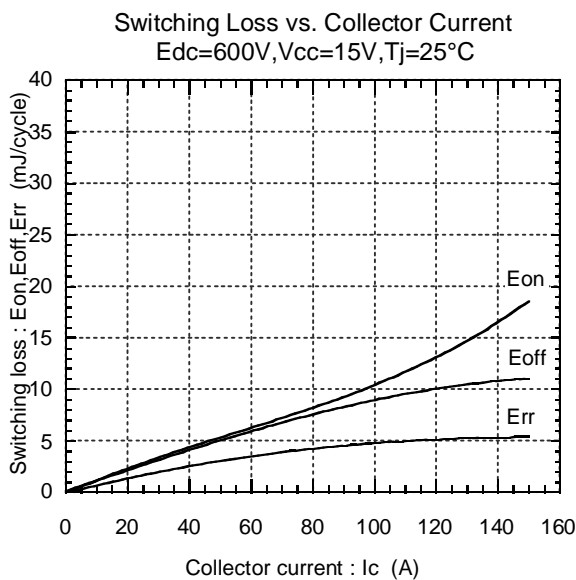
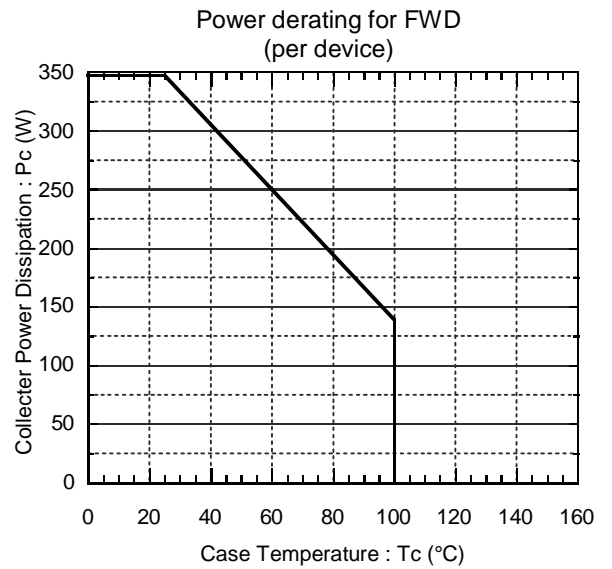
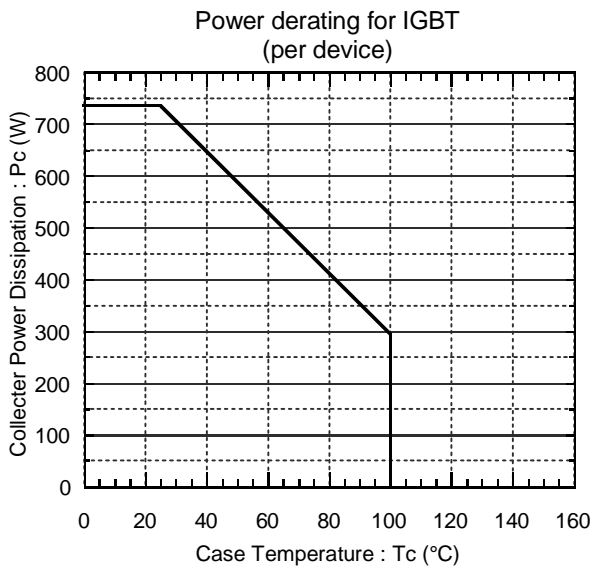
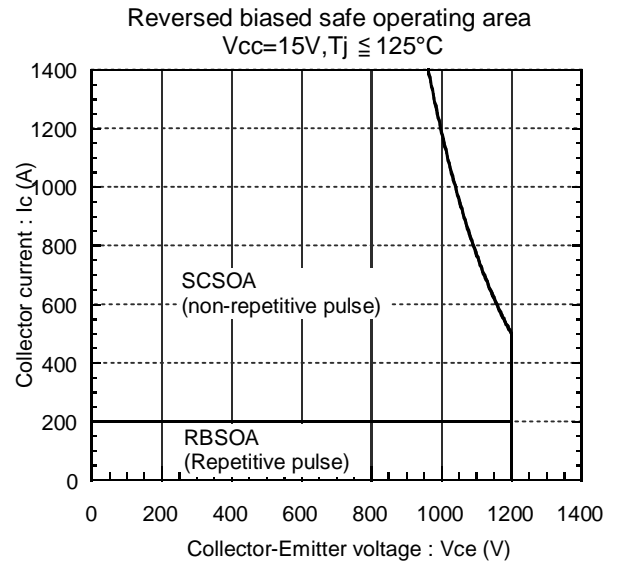
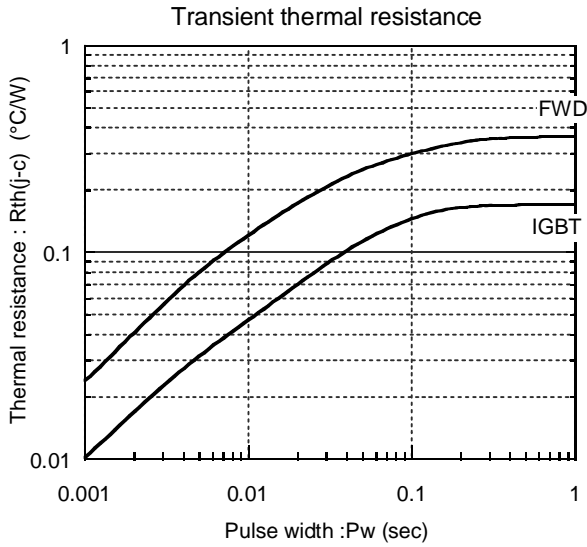

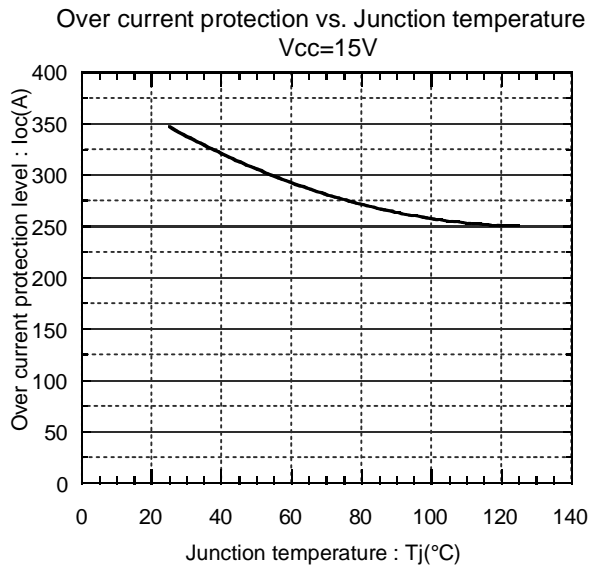

● Brake

Collector current vs. Collector-Emitter voltage
T_j=25°C

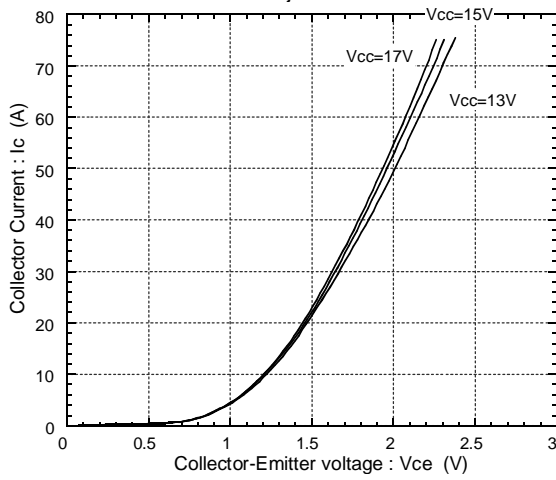

Collector current vs. Collector-Emitter voltage
T_j=125°C

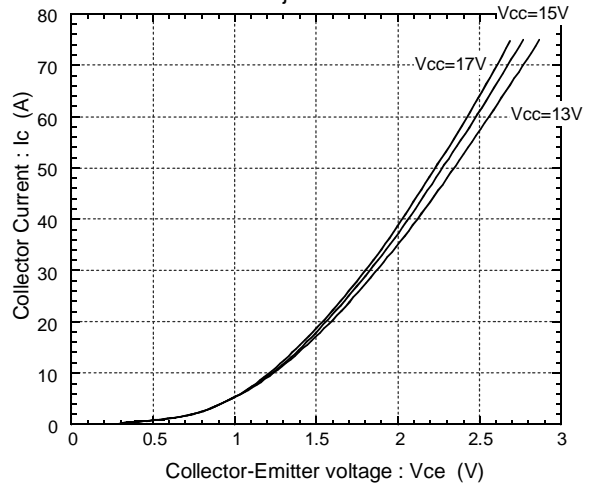

Transient thermal resistance

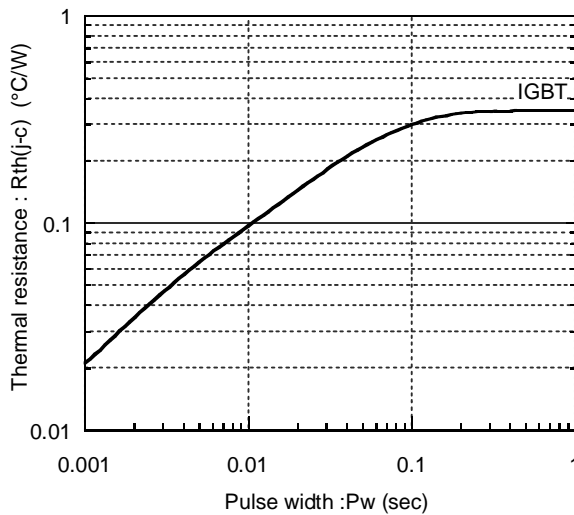

Reversed biased safe operating area
V_{cc}=15V, T_j 125°C

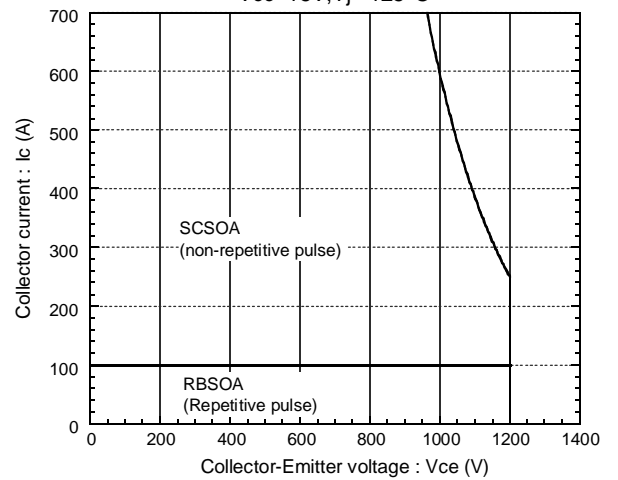

Power derating for IGBT
(per device)

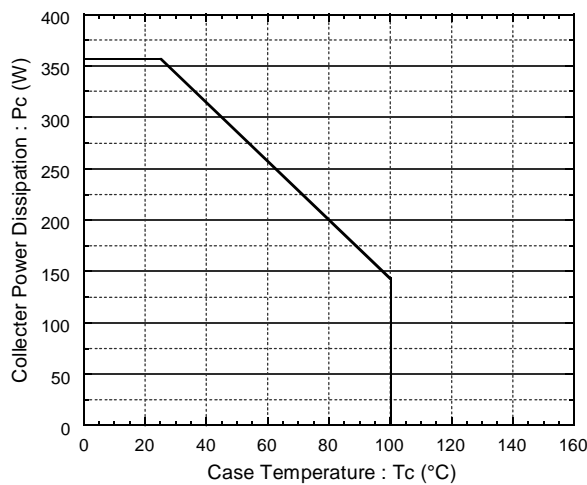

Over current protection vs. Junction temperature
V_{cc}=15V

