

7MBP300RA060

IGBT-IPM R series

600V / 300A 7 in one-package

Features

- Temperature protection provided by directly detecting the junction temperature of the IGBTs
- Low power loss and soft switching
- High performance and high reliability IGBT with overheating protection
- Higher reliability because of a big decrease in number of parts in built-in control circuit

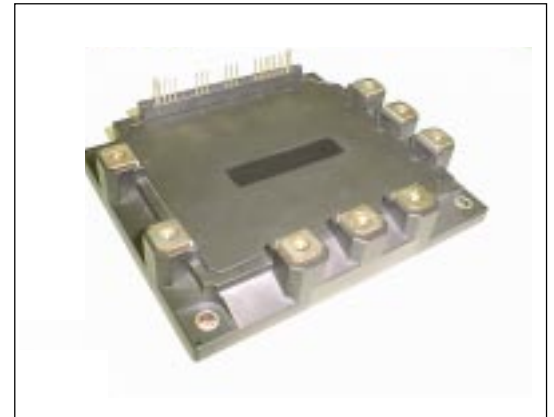

Maximum ratings and characteristics

- Absolute maximum ratings(at $T_c=25^{\circ}\text{C}$ unless otherwise specified)

Item	Symbol	Rating		Unit		
		Min.	Max.			
DC bus voltage	V_{DC}	0	450	V		
DC bus voltage (surge)	$V_{DC(surge)}$	0	500	V		
DC bus voltage (short operating)	V_{SC}	200	400	V		
Collector-Emitter voltage	V_{CES}	0	600	V		
DB Reverse voltage	V_R	-	600	V		
INV	Collector current	DC	I_C	-	300	A
		1ms	I_{CP}	-	600	A
		Duty=55.5%	$-I_C$	-	300	A
	Collector power dissipation	One transistor	P_C	-	1040	W
DB	Collector current	DC	I_C	-	100	A
		1ms	I_{CP}	-	200	A
	Forward current of Diode		I_F	-	100	A
	Collector power dissipation	One transistor	P_C	-	400	W
Junction temperature		T_j	-	150	$^{\circ}\text{C}$	
Input voltage of power supply for Pre-Driver		$V_{CC} *1$	0	20	V	
Input signal voltage		$V_{in} *2$	0	V_Z	V	
Input signal current		I_{in}	-	1	mA	
Alarm signal voltage		$V_{ALM} *3$	0	V_{CC}	V	
Alarm signal current		$I_{ALM} *4$	-	15	mA	
Storage temperature		T_{stg}	-40	125	$^{\circ}\text{C}$	
Operating case temperature		T_{op}	-20	100	$^{\circ}\text{C}$	
Isolating voltage (Case-Terminal)		$V_{iso} *5$	-	AC2.5	kV	
Screw torque	Mounting (M5)		-	3.5 *6	N·m	
	Terminal (M5)		-	3.5 *6	N·m	

*1 Apply V_{CC} between terminal No. 3 and 1, 6 and 4, 9 and 7, 11 and 10.

*2 Apply V_{in} between terminal No. 2 and 1, 5 and 4, 8 and 7, 12,13,14,15 and 10.

*3 Apply V_{ALM} between terminal No. 16 and 10.

*4 Apply I_{ALM} to terminal No. 16.

*5 50Hz/60Hz sine wave 1 minute.

*6 Recommendable Value : 2.5 to 3.0 N·m

- Electrical characteristics of power circuit (at $T_c=T_j=25^{\circ}\text{C}$, $V_{CC}=15\text{V}$)

Item	Symbol	Condition	Min.	Typ.	Max.	Unit	
INV	Collector current at off signal input	I_{CES}	$V_{CE}=600\text{V}$ input terminal open	-	-	1.0	mA
	Collector-Emitter saturation voltage	$V_{CE(sat)}$	$I_C=300\text{A}$	-	-	2.8	V
	Forward voltage of FWD	V_F	$-I_C=300\text{A}$	-	-	3.0	V
DB	Collector current at off signal input	I_{CES}	$V_{CE}=600\text{V}$ input terminal open	-	-	1.0	mA
	Collector-Emitter saturation voltage	$V_{CE(sat)}$	$I_C=100\text{A}$	-	-	2.8	V
	Forward voltage of Diode	V_F	$-I_C=100\text{A}$	-	-	3.0	V

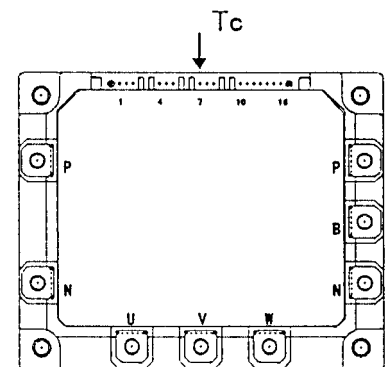

Fig.1 Measurement of case temperature

● Electrical characteristics of control circuit(at $T_c=T_j=25^\circ\text{C}$, $V_{cc}=15\text{V}$)

Item	Symbol	Condition	Min.	Typ.	Max.	Unit
Power supply current of P-line side Pre-driver(one unit)	I_{ccp}	fsw=0 to 15kHz $T_c=-20$ to 100°C *7	6	-	32	mA
Power supply current of N-line side three Pre-driver	I_{ccn}	fsw=0 to 15kHz $T_c=-20$ to 100°C *7	24	-	114	mA
Input signal threshold voltage (on/off)	$V_{in(th)}$	ON	1.00	1.35	1.70	V
		OFF	1.70	2.05	2.40	V
Input zener voltage	V_z	$R_{in}=20\text{k ohm}$	-	8.0	-	V
Over heating protection temperature level	T_{COH}	$V_{DC}=0\text{V}$, $I_c=0\text{A}$, Case temperature, Fig.1	110	-	125	$^\circ\text{C}$
Hysteresis	T_{CH}		-	20	-	$^\circ\text{C}$
IGBT chips over heating protection temperature level	T_{jOH}	surface of IGBT chips	150	-	-	$^\circ\text{C}$
Hysteresis	T_{jH}		-	20	-	$^\circ\text{C}$
Collector current protection level	INV	I_{oc}	$T_j=125^\circ\text{C}$	450	-	A
	DB	I_{oc}	$T_j=125^\circ\text{C}$	150	-	A
Over current protection delay time (Fig.2)	t_{DOC}	$T_j=25^\circ\text{C}$ Fig.2	-	10	-	μs
Under voltage protection level	V_{UV}		11.0	-	12.5	V
Hysteresis	V_H		0.2	-	-	V
Alarm signal hold time	t_{ALM}		1.5	2	-	ms
SC protection delay time	t_{SC}	$T_j=25^\circ\text{C}$ Fig.3	-	-	12	μs
Limiting resistor for alarm	R_{ALM}		1425	1500	1575	ohm

*7 Switching frequency of IPM

● Dynamic characteristics(at $T_c=T_j=125^\circ\text{C}$, $V_{cc}=15\text{V}$)

Item	Symbol	Condition	Min.	Typ.	Max.	Unit
Switching time (IGBT)	t_{on}	$I_C=300\text{A}$, $V_{DC}=300\text{V}$	0.3	-	-	μs
	t_{off}		-	-	3.6	μs
Switching time (FWD)	t_{rr}	$I_F=300\text{A}$, $V_{DC}=300\text{V}$	-	-	0.4	μs

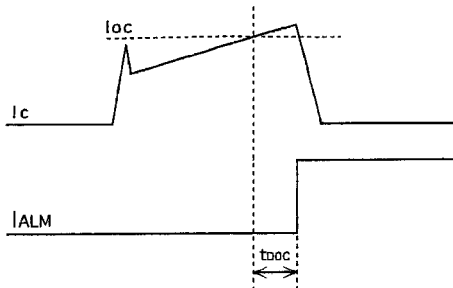

Fig.2 Definition of OC delay time

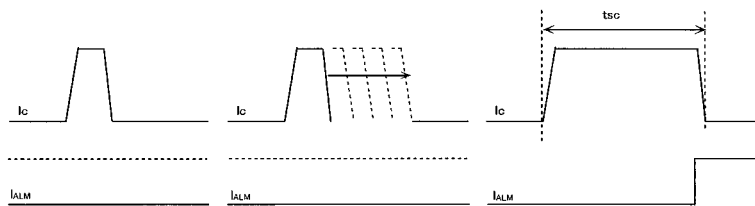

Fig.3 Definition of t_{sc}

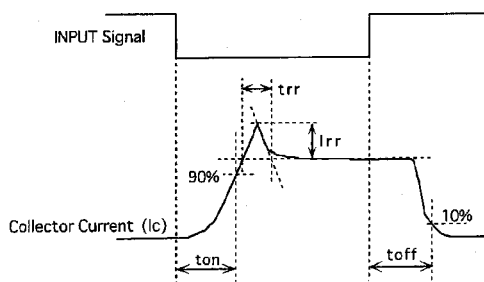

Fig.4 Definition of switching time

● Thermal characteristics($T_c=25^\circ\text{C}$)

Item	Symbol	Typ.	Max.	Unit
Junction to Case thermal resistance	INV	IGBT	0.12	$^\circ\text{C/W}$
		FWD	0.25	$^\circ\text{C/W}$
	DB	IGBT	0.31	$^\circ\text{C/W}$
Case to fin thermal resistance with compound	$R_{th(c-f)}$	0.05	-	$^\circ\text{C/W}$

● Recommendable value

Item	Symbol	Min.	Typ.	Max.	Unit
DC bus voltage	V_{DC}	200	-	400	V
Operating power supply voltage range of Pre-driver	V_{CC}	13.5	15	16.5	V
Switching frequency of IPM	fsw	1	-	20	kHz
Screw torque	Mounting (M5)	2.5	-	3.0	N·m
	Terminal (M5)	2.5	-	3.0	N·m

Block diagram

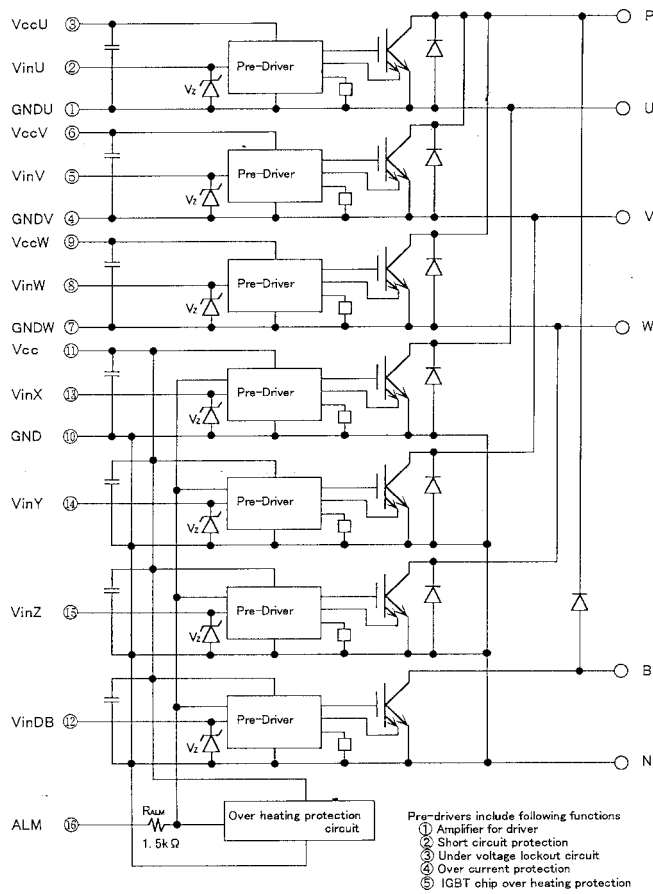

Pre-drivers include following functions
 a) Amplifier for driver
 b) Short circuit protection
 c) Undervoltage lockout circuit
 d) Over current protection
 e) IGBT chip over heating protection

Pre-drivers include following functions
 ① Amplifier for driver
 ② Short circuit protection
 ③ Undervoltage lockout circuit
 ④ Over current protection
 ⑤ IGBT chip over heating protection

Outline drawings, mm

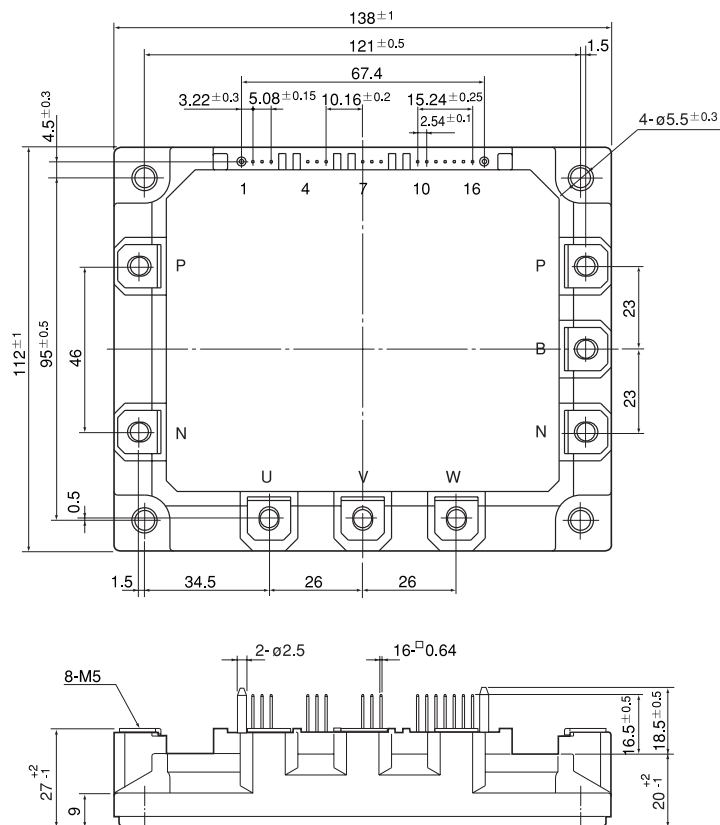

Mass : 920g

Characteristics (Representative)

Control circuit

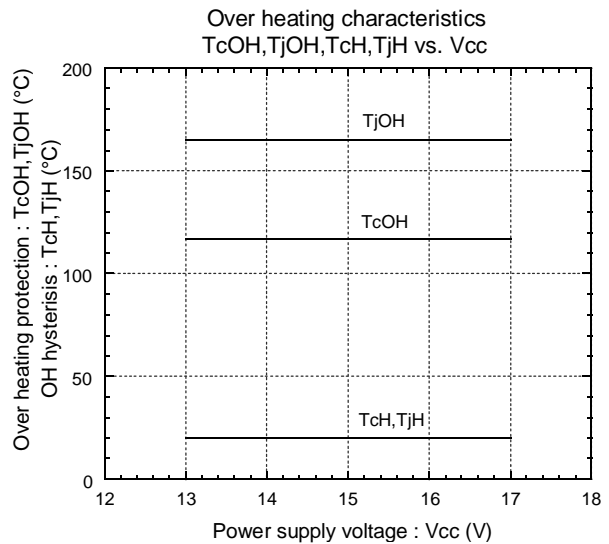
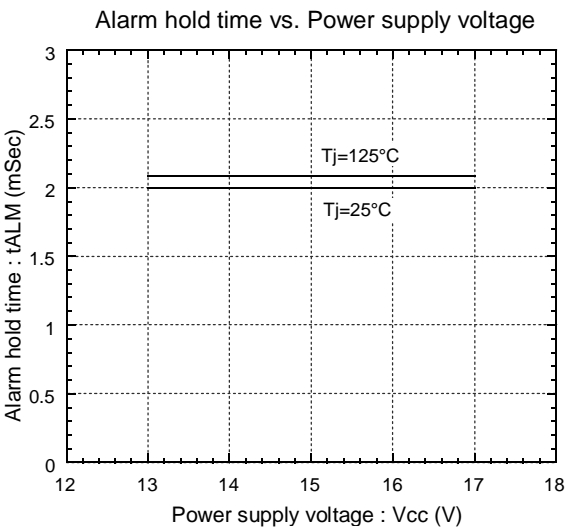
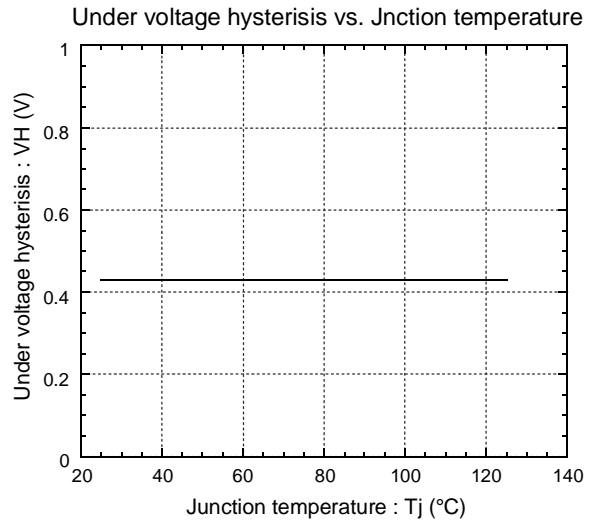
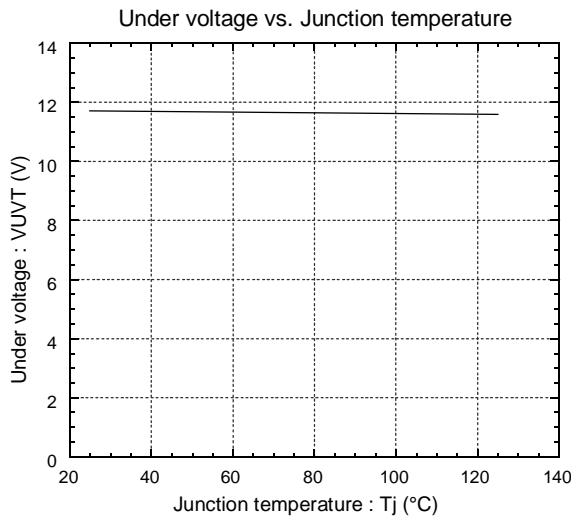
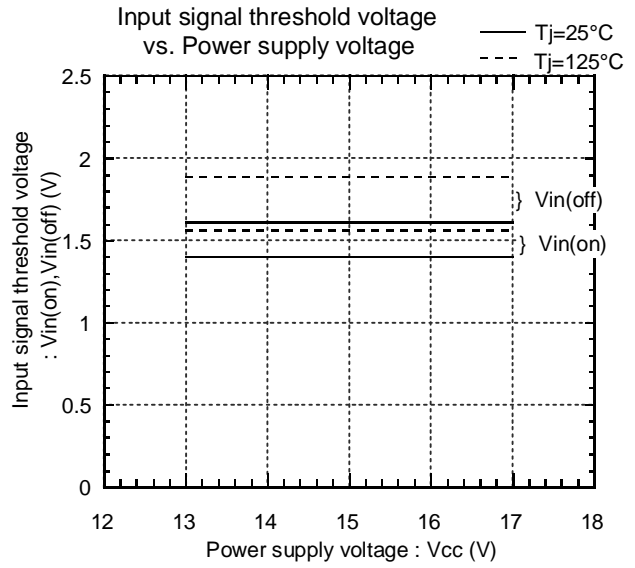
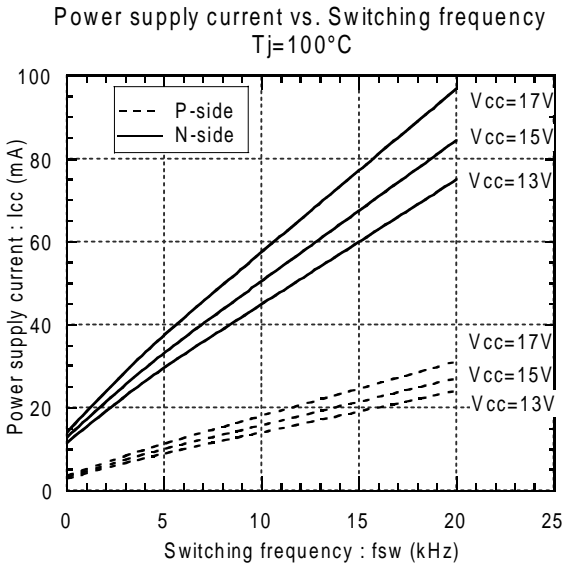

● Inverter

Collector current vs. Collector-Emitter voltage
T_j=25°C

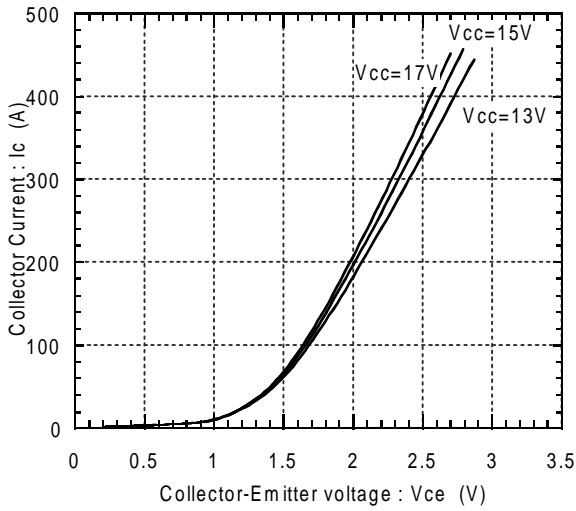

Collector current vs. Collector-Emitter voltage
T_j=125°C

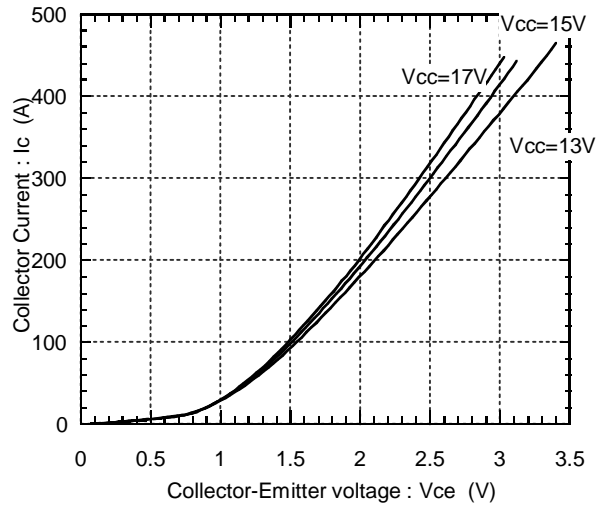

Switching time vs. Collector current
E_{dc}=300V, V_{cc}=15V, T_j=25°C

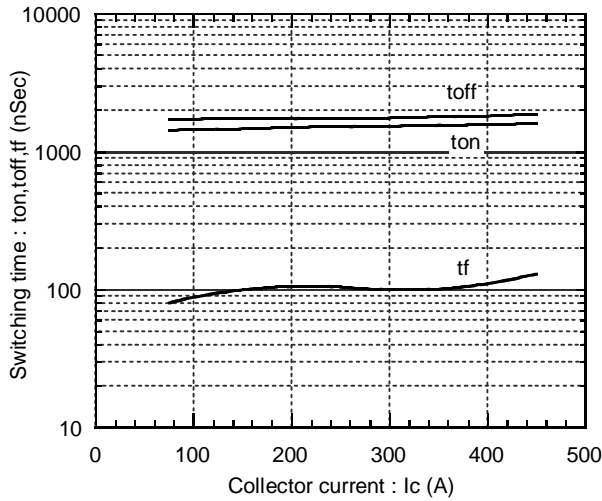

Switching time vs. Collector current
E_{dc}=300V, V_{cc}=15V, T_j=125°C

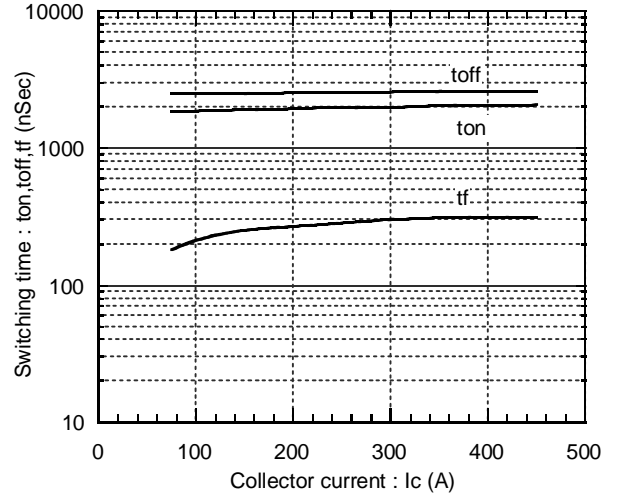

Forward current vs. Forward voltage

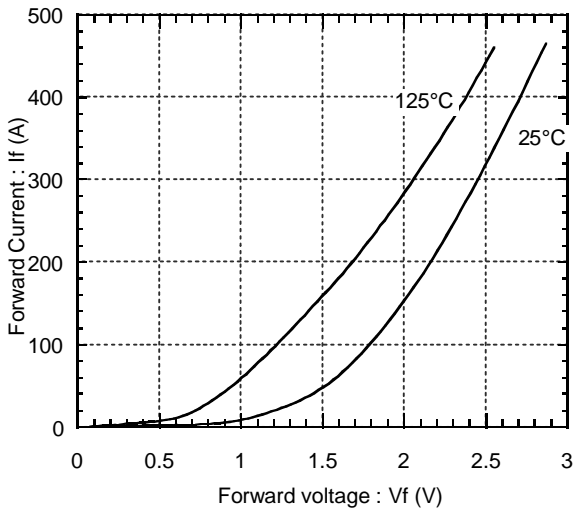

Reverse recovery characteristics
trr, Irr vs. IF

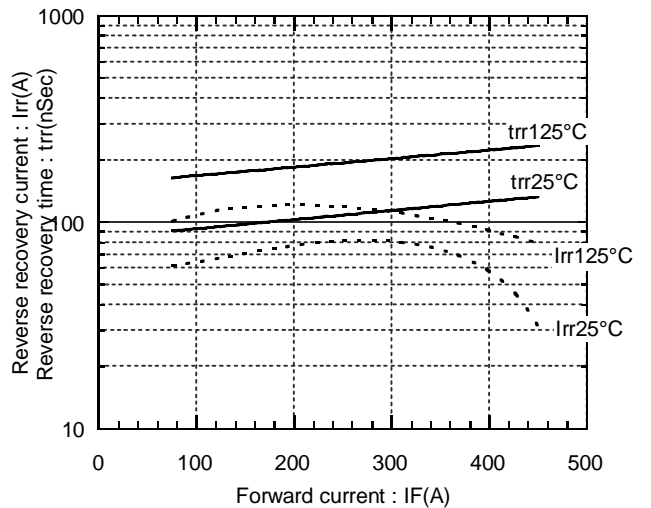

Transient thermal resistance

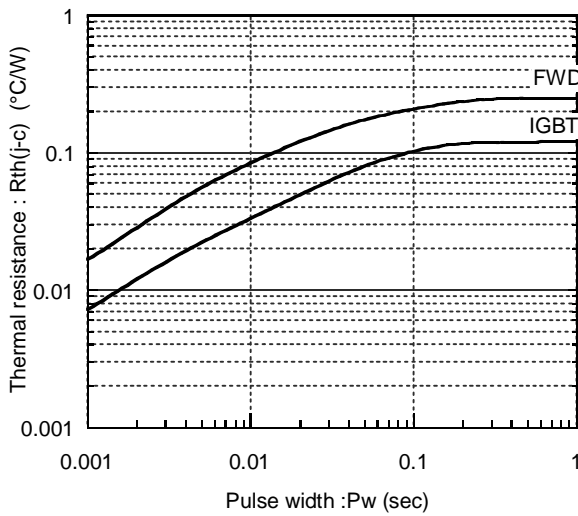

Reversed biased safe operating area
 $V_{cc}=15V, T_j \leq 125^{\circ}C$

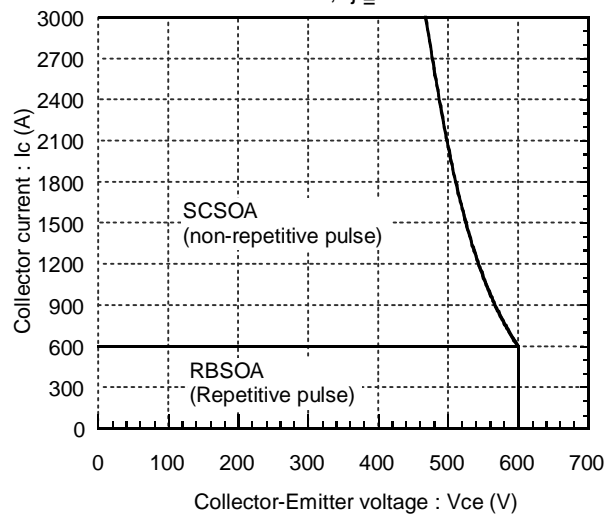

Power derating for IGBT
(per device)

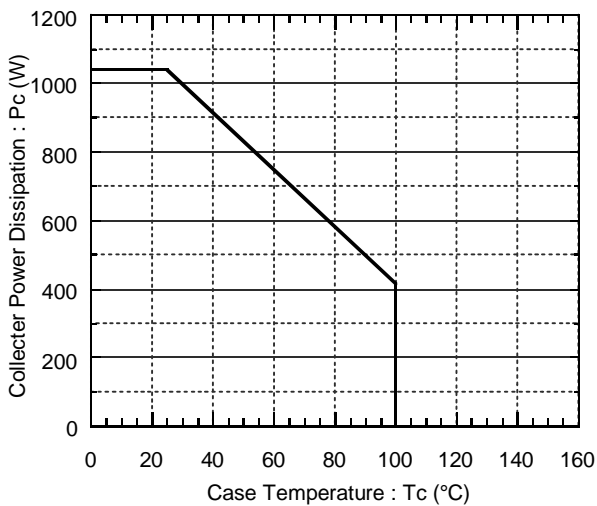

Power derating for FWD
(per device)

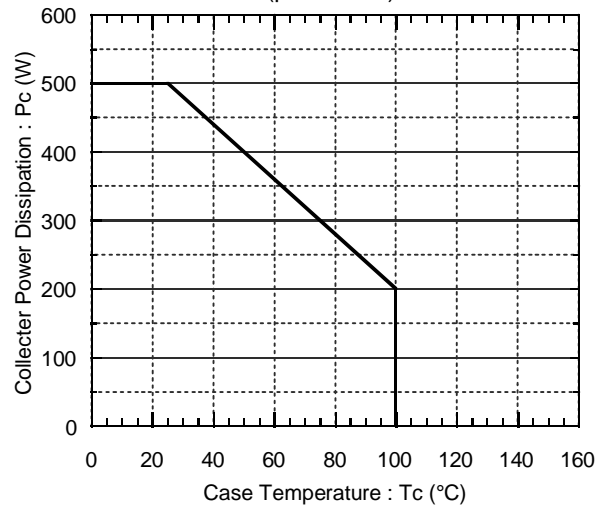

Switching Loss vs. Collector Current
 $E_{dc}=300V, V_{cc}=15V, T_j=25^{\circ}C$

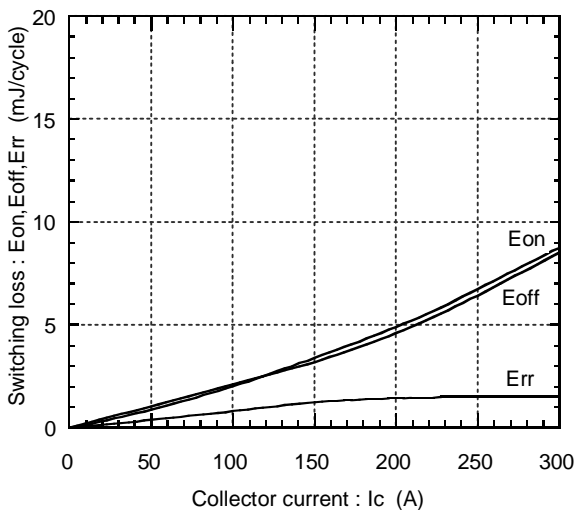

Switching Loss vs. Collector Current
 $E_{dc}=300V, V_{cc}=15V, T_j=125^{\circ}C$

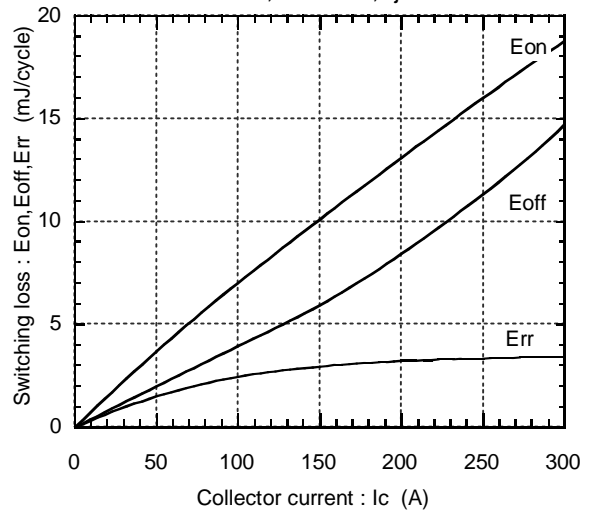

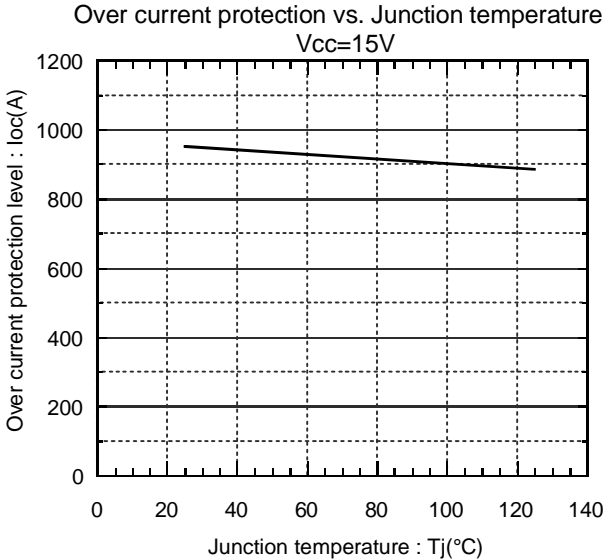

● Brake

Collector current vs. Collector-Emitter voltage
T_j=25°C

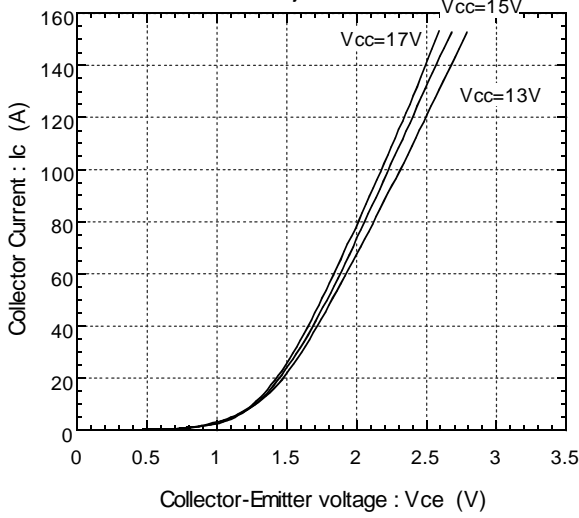

Collector current vs. Collector-Emitter voltage
T_j=125°C

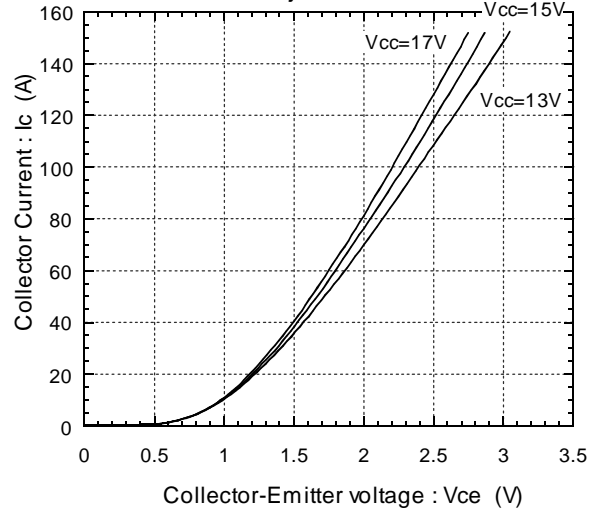

Transient thermal resistance

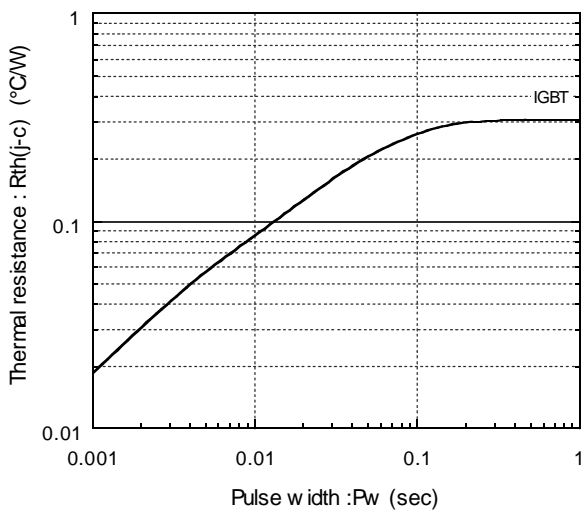

Reversed biased safe operating area
V_{cc}=15V, T_j ≤ 125°C

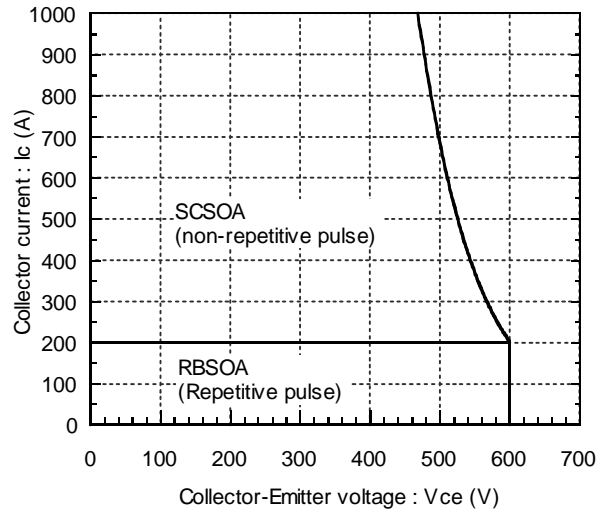

Power derating for IGBT
(per device)

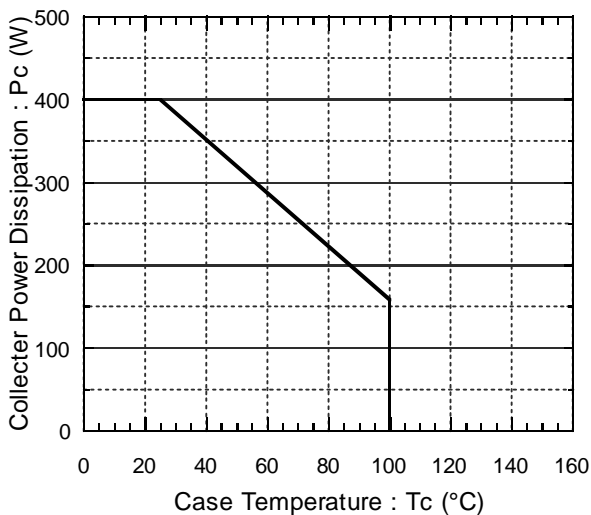

Over current protection vs. Junction temperature
V_{cc}=15V

