

IGBT MODULE (S series) 1400V / 10A / PIM



■ Features

- Low $V_{CE(sat)}$
- Compact Package
- P.C. Board Mount Module
- Converter Diode Bridge Dynamic Brake Circuit

■ Applications

- Inverter for Motoe Drive
- AC and DC Servo Drive Amplifier
- Uninterruptible Power Supply

■ Maximum ratings and characteristics

● Absolute maximum ratings ($T_c=25^\circ\text{C}$ unless without specified)

Item	Symbol	Condition	Rating	Unit		
Inverter	Collector-Emitter voltage	V_{CES}	1400	V		
	Gate-Emitter voltage	V_{GES}	± 20	V		
	Collector current	I_C	Continuous	$T_c=25^\circ\text{C}$	15	A
				$T_c=75^\circ\text{C}$	10	A
		I_{CP}	1ms	$T_c=25^\circ\text{C}$	30	A
				$T_c=75^\circ\text{C}$	20	A
	$<I_C$		10	A		
Collector power dissipation	P_C	1 device	75	W		
Brake	Collector-Emitter voltage	V_{CES}	1400	V		
	Gate-Emitter voltage	V_{GES}	± 20	V		
	Collector current	I_C	Continuous	$T_c=25^\circ\text{C}$	15	A
				$T_c=75^\circ\text{C}$	10	A
		I_{CP}	1ms	$T_c=25^\circ\text{C}$	30	A
				$T_c=75^\circ\text{C}$	20	A
Collector power dissipation	P_C	1 device	75	W		
Repetitive peak reverse voltage	V_{RRM}		1400	V		
Converter	Repetitive peak reverse voltage	V_{RRM}	1600	V		
	Average output current	I_O	50Hz/60Hz sine wave	10	A	
	Surge current (Non-Repetitive)	I_{FSM}	$T_j=150^\circ\text{C}$, 10ms	105	A	
	I^2t (Non-Repetitive)	I^2t	half sine wave		55	A^2s
Operating junction temperature	T_j		+150	$^\circ\text{C}$		
Storage temperature	T_{stg}		-40 to +125	$^\circ\text{C}$		
Isolation voltage	between terminal and copper base *2	V_{iso}	AC : 1 minute	AC 2500	V	
	between thermistor and others *3			AC 2500	V	
Mounting screw torque			3.5 *1	N·m		

*1 Recommendable value : 2.5 to 3.5 N·m (M5)

*2 All terminals should be connected together when isolation test will be done.

*3 Terminal 8 and 9 should be connected together. Terminal 1 to 7 and 10 to 24 should be connected together and shorted to copper base.

● Electrical characteristics (T_j=25°C unless otherwise specified)

Item	Symbol	Condition	Characteristics			Unit			
			Min.	Typ.	Max.				
Inverter	Zero gate voltage collector current	ICES	V _{CE} =1400V, V _{GE} =0V			1.0	mA		
	Gate-Emitter leakage current	IGES	V _{CE} =0V, V _{GE} =±20V			0.2	μA		
	Gate-Emitter threshold voltage	V _{GE(th)}	V _{CE} =20V, I _c =10mA			5.5	7.2	8.5	V
	Collector-Emitter saturation voltage	V _{CE(sat)}	V _{GE} =15V, I _c =10A	chip	2.2			V	
				terminal	2.25	2.7			
	Input capacitance	C _{ies}	V _{GE} =0V, V _{CE} =10V, f=1MHz			1200		pF	
	Turn-on time	ton	V _{CC} =800V			0.35	1.2		μs
		tr	I _c =10A			0.25	0.6		
		tr(i)	V _{GE} =±15V			0.1			
	Turn-off	toff	R _G =120Ω			0.45	1.0		
tf					0.08	0.3			
Forward on voltage	V _F	I _F =10A	chip	2.4			V		
			terminal	2.45	3.3				
Reverse recovery time of FRD	t _{rr}	I _F =10A				0.35		μs	
Brake	Zero gate voltage collector current	ICES	V _{CEs} =1400V, V _{GE} =0V			1.0		mA	
	Gate-Emitter leakage current	IGES	V _{CE} =0V, V _{GE} =±20V			0.2		μA	
	Collector-Emitter saturation voltage	V _{CE(sat)}	I _c =10A, V _{GE} =15V	chip	2.2			V	
				terminal	2.3	2.7			
	Turn-on time	ton	V _{CC} =800V			0.35	1.2		μs
		tr	I _c =10A			0.25	0.6		
	Turn-off time	toff	V _{GE} =±15V			0.45	1.0		
		tf	R _G =120 Ω			0.08	0.3		
	Reverse current	I _{RRM}	V _R =1400V				1.0		mA
	Converter	Forward on voltage	V _{FM}	I _F =10A	chip	1.1			V
terminal					1.2	1.5			
Reverse current	I _{RRM}	V _R =1600V				1.0		mA	
Resistance	R	T=25°C	5000					Ω	
			T=100°C	465	495	520			
B value	B	T=25/50°C			3305	3375	3450	K	

● Thermal resistance Characteristics

Item	Symbol	Condition	Characteristics			Unit
			Min.	Typ.	Max.	
Thermal resistance (1 device)	R _{th(j-c)}	Inverter IGBT			1.67	°C/W
		Inverter FWD			2.78	
		Brake IGBT			1.67	
		Converter Diode			1.85	
Contact thermal resistance	R _{th(c-f)}	With thermal compound		0.05		

* This is the value which is defined mounting on the additional cooling fin with thermal compound

■ Equivalent Circuit Schematic

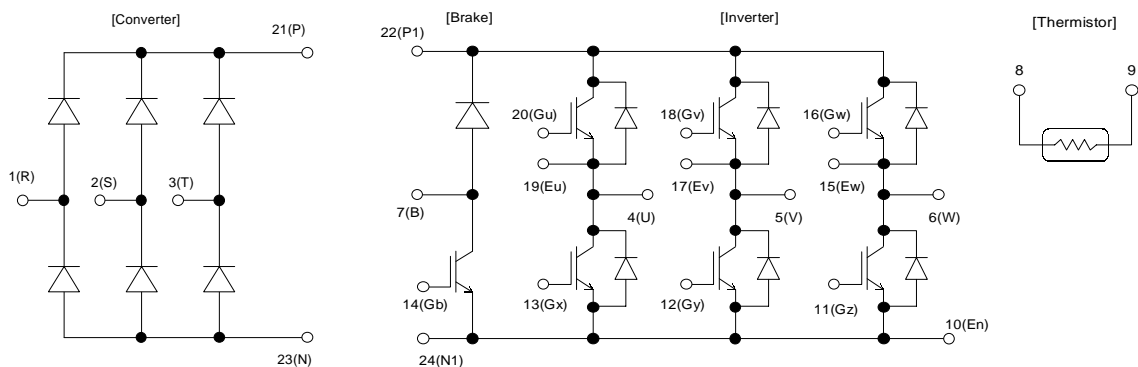

Characteristics (Representative)

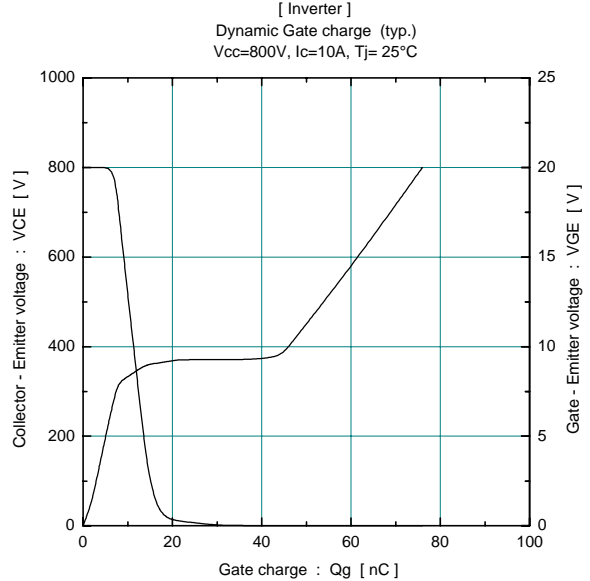
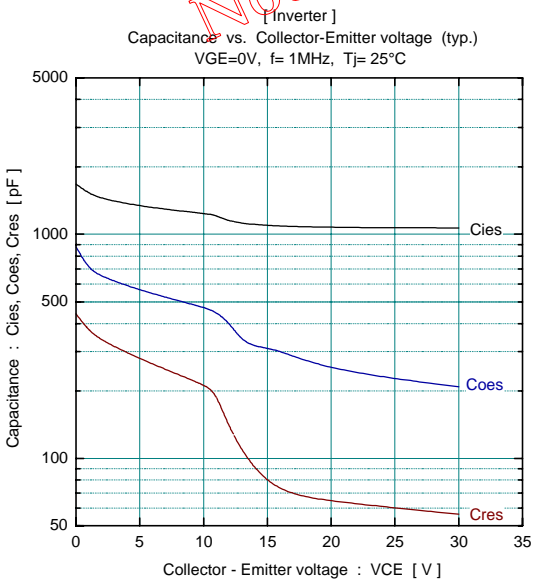
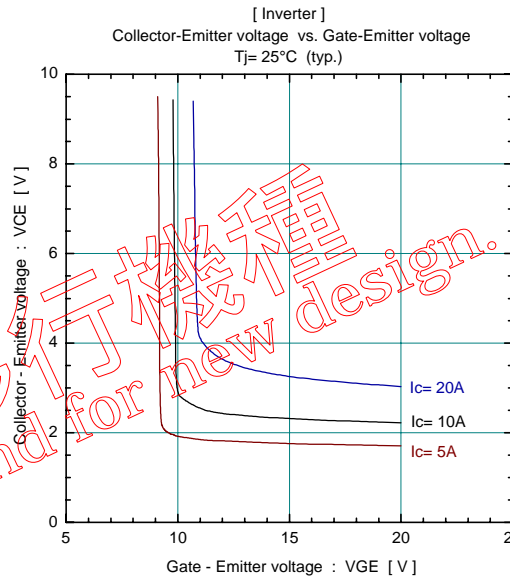
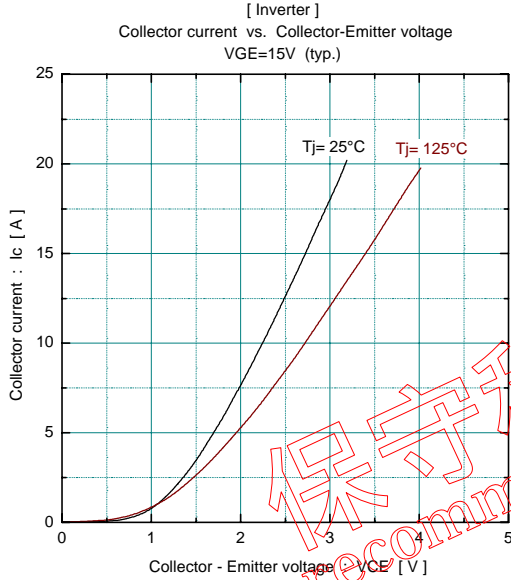
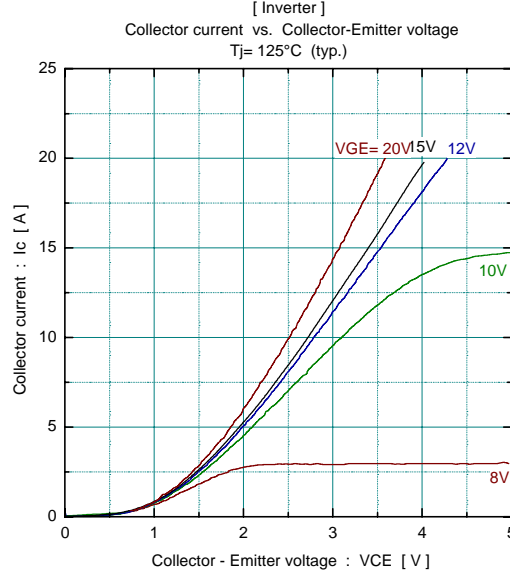
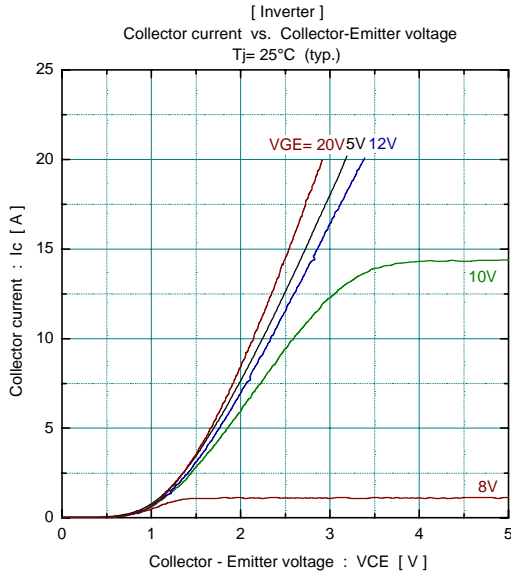

保守移行機種
Not recommend for new design.

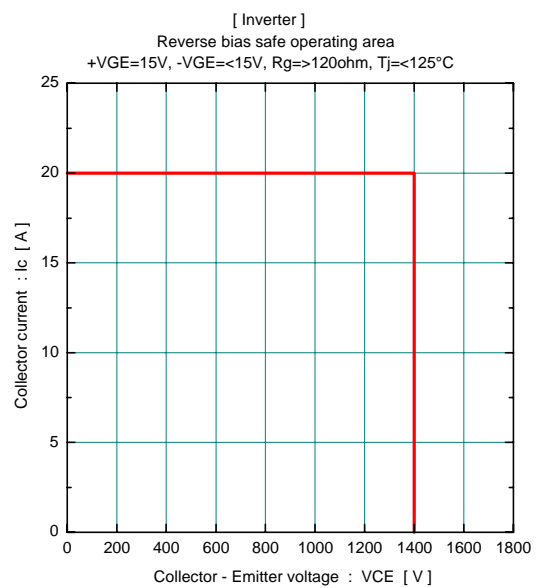
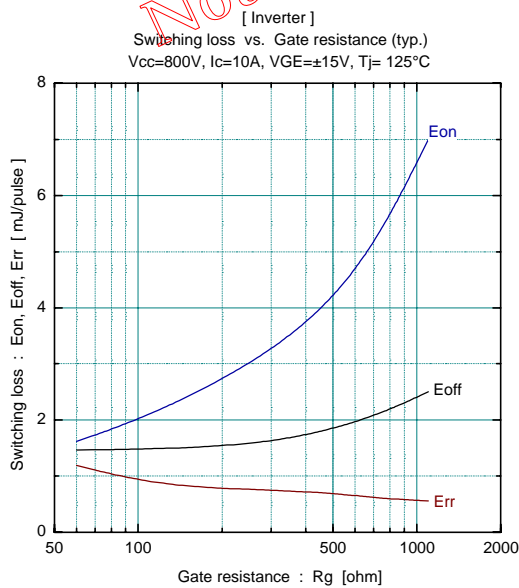
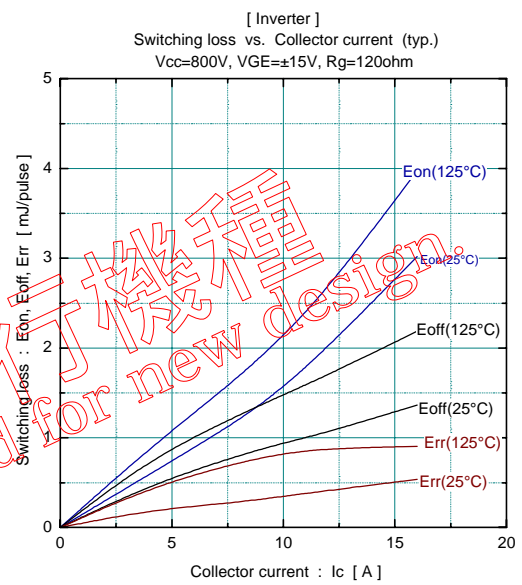
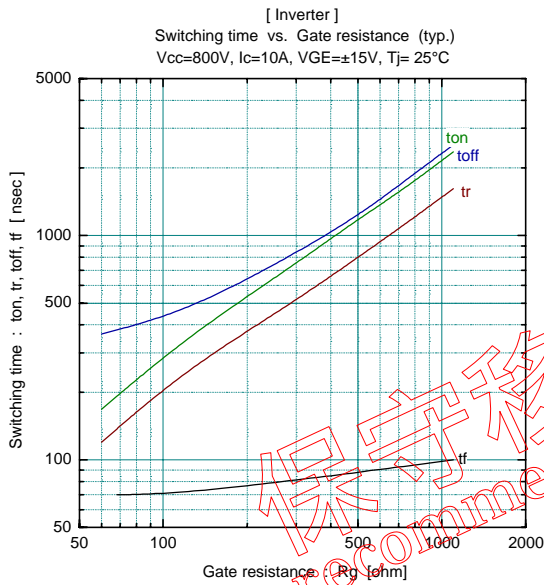
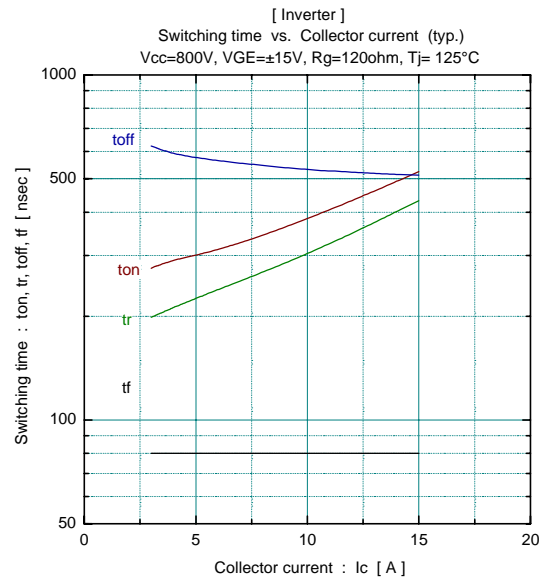
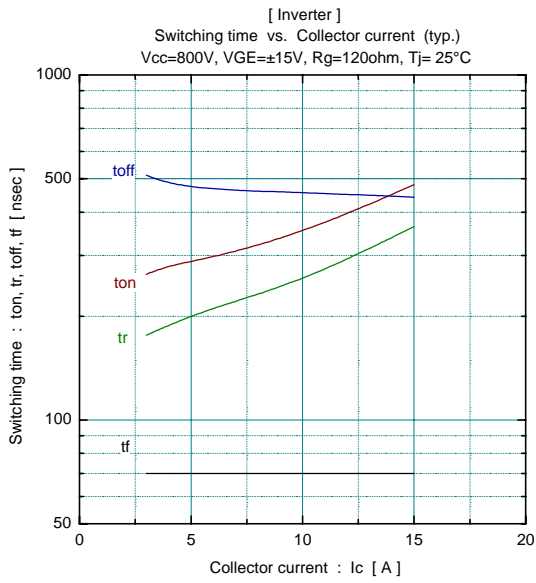

Not recommend for new design

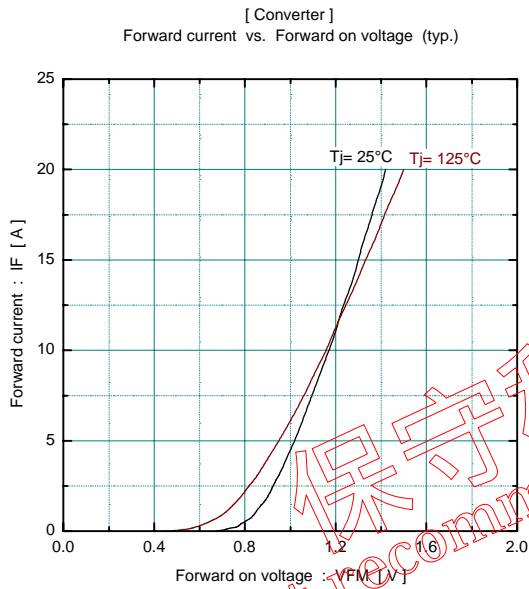
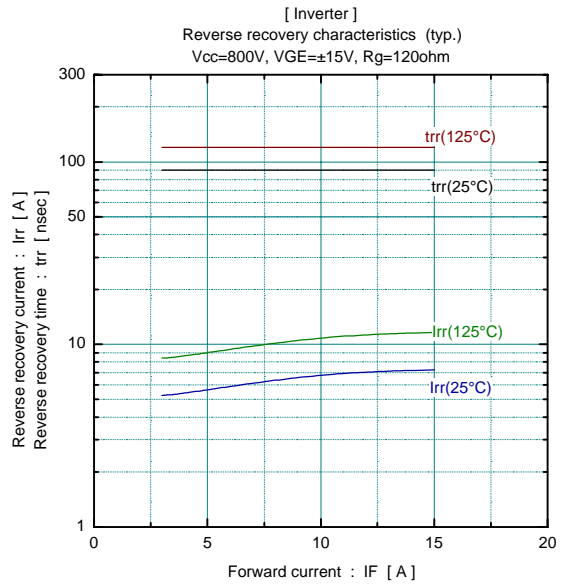
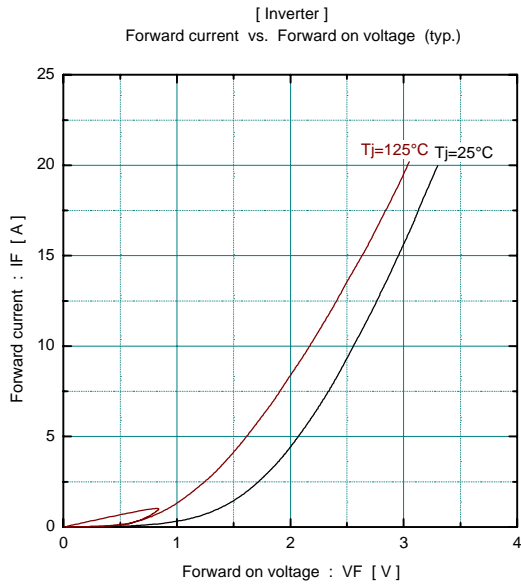

保守移行機種
Not recommend for new design.

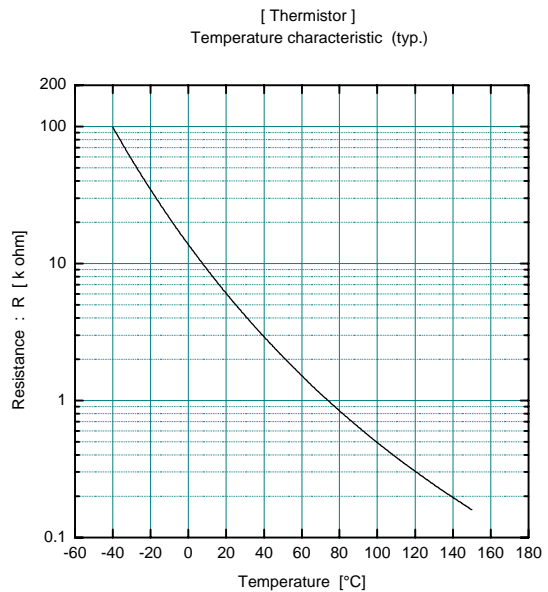
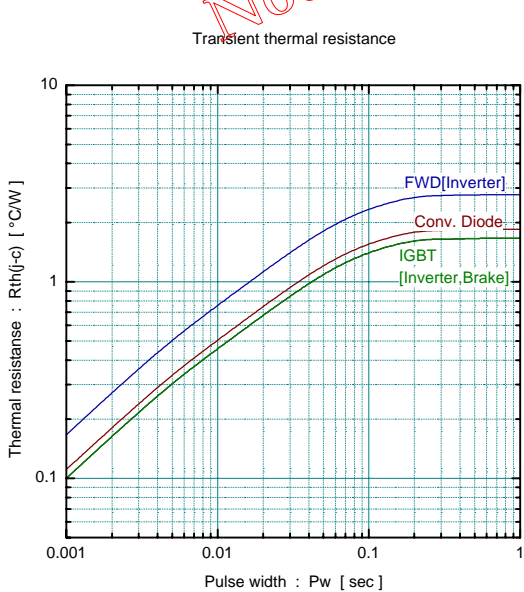

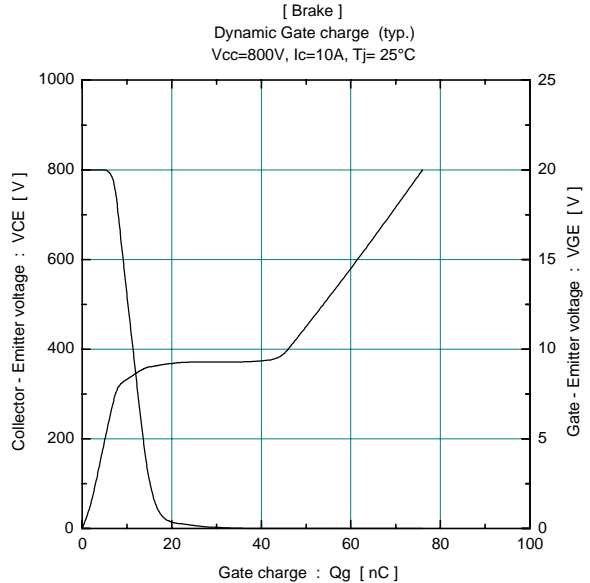
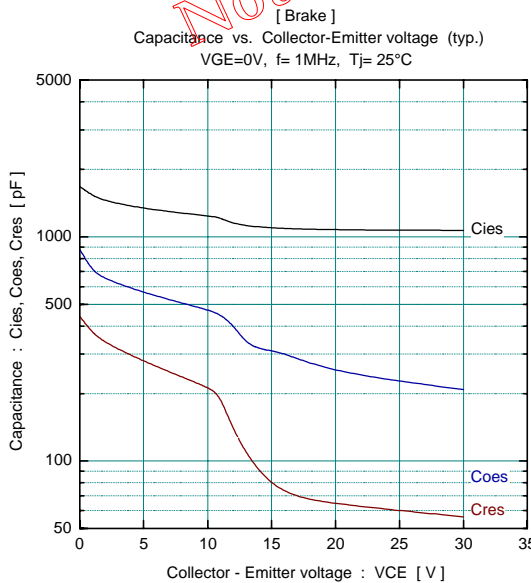
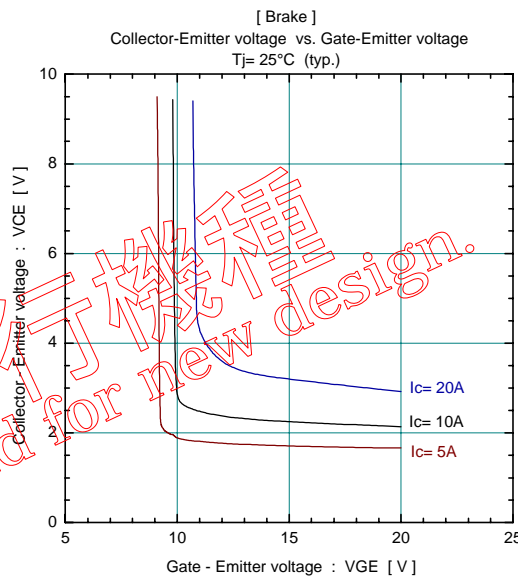
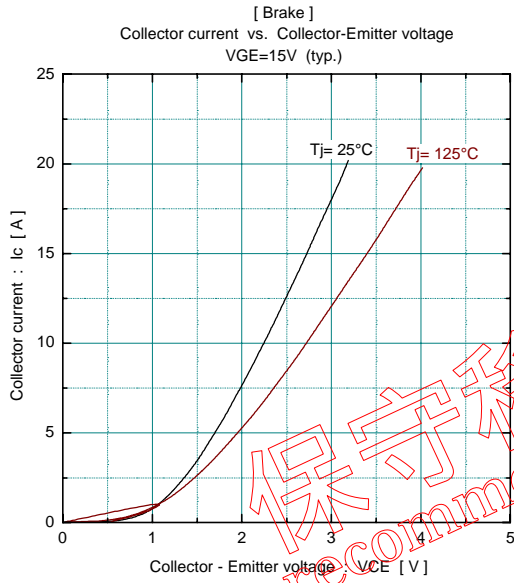
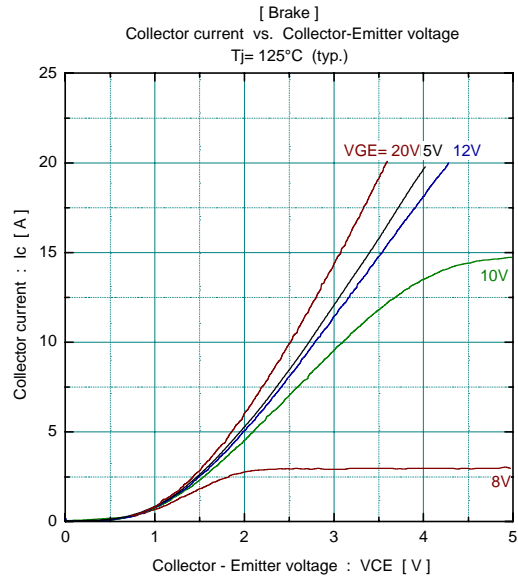
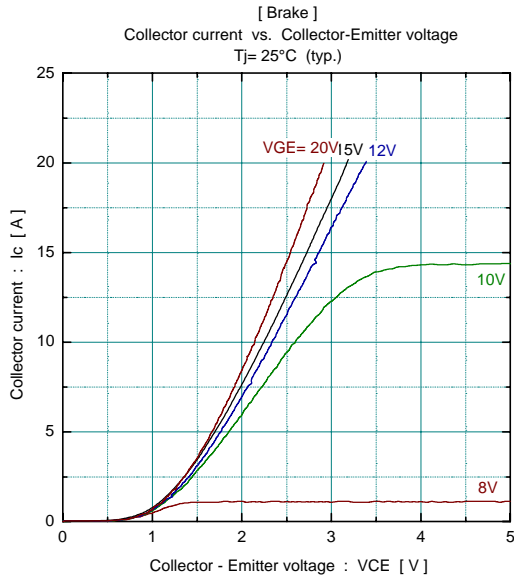

保守移行機種
Not recommend for new design.

■ Outline Drawings, mm

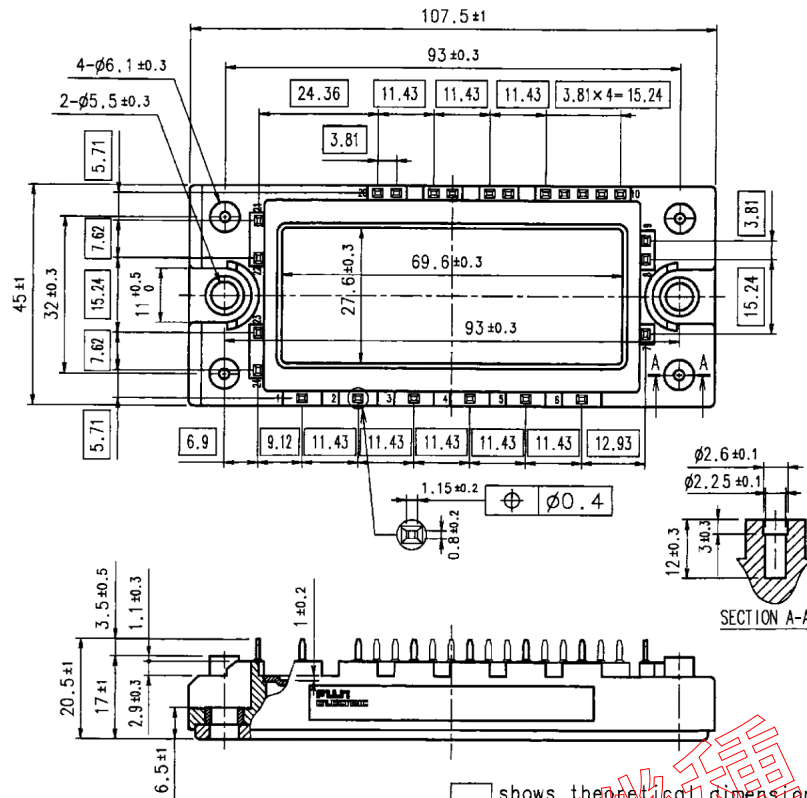

mass : 180g

保守移行機種
 Not recommend for new design.