

IGBT MODULE (S series) 1400V / 35A / PIM



■ Features

- Low $V_{CE(sat)}$
- Compact Package
- P.C. Board Mount Module
- Converter Diode Bridge Dynamic Brake Circuit

■ Applications

- Inverter for Motoe Drive
- AC and DC Servo Drive Amplifier
- Uninterruptible Power Supply

■ Maximum ratings and characteristics

● Absolute maximum ratings ($T_c=25^\circ\text{C}$ unless without specified)

Item	Symbol	Condition	Rating	Unit	
Inverter	Collector-Emitter voltage	V_{CES}	1400	V	
	Gate-Emitter voltage	V_{GES}	± 20	V	
	Collector current	I_c	Continuous	$T_c=25^\circ\text{C}$ $T_c=75^\circ\text{C}$	50 35
			I_{CP}	1ms	$T_c=25^\circ\text{C}$ $T_c=75^\circ\text{C}$
		$\leq I_c$			35
	Collector power dissipation	P_C	1 device	240	W
Brake	Collector-Emitter voltage	V_{CES}	1400	V	
	Gate-Emitter voltage	V_{GES}	± 20	V	
	Collector current	I_c	Continuous	$T_c=25^\circ\text{C}$ $T_c=75^\circ\text{C}$	35 25
			I_{CP}	1ms	$T_c=25^\circ\text{C}$ $T_c=75^\circ\text{C}$
		Collector power dissipation		P_C	1 device
	Repetitive peak reverse voltage	V_{RRM}		1400	V
Converter	Repetitive peak reverse voltage	V_{RRM}	1600	V	
	Average output current	I_O	50Hz/60Hz sine wave	35	
	Surge current (Non-Repetitive)	I_{FSM}	$T_j=150^\circ\text{C}$, 10ms	360	
	I^2t (Non-Repetitive)	I^2t	half sine wave	648	
Operating junction temperature	T_j		+150	$^\circ\text{C}$	
Storage temperature	T_{stg}		-40 to +125	$^\circ\text{C}$	
Isolation voltage	between terminal and copper base *2	V_{iso}	AC : 1 minute	AC 2500	
	between thermistor and others *3			AC 2500	
Mounting screw torque			3.5 *1	N·m	

*1 Recommendable value : 2.5 to 3.5 N·m (M5)

*2 All terminals should be connected together when isolation test will be done.

*3 Terminal 8 and 9 should be connected together. Terminal 1 to 7 and 10 to 24 should be connected together and shorted to copper base.

● Electrical characteristics (T_j=25°C unless otherwise specified)

Item	Symbol	Condition	Characteristics			Unit		
			Min.	Typ.	Max.			
Inverter	Zero gate voltage collector current	ICES	V _{CE} =1400V, V _{GE} =0V		1.0	mA		
	Gate-Emitter leakage current	IGES	V _{CE} =0V, V _{GE} =±20V		0.2	μA		
	Gate-Emitter threshold voltage	V _{GE(th)}	V _{CE} =20V, I _c =35mA		5.5	7.2	8.5	V
	Collector-Emitter saturation voltage	V _{CE(sat)}	V _{GE} =15V, I _c =35A	chip	2.2		V	
				terminal	2.35	2.7		
	Input capacitance	C _{ies}	V _{GE} =0V, V _{CE} =10V, f=1MHz		4200		pF	
	Turn-on time	ton	V _{CC} =800V		0.35	1.2	μs	
		tr	I _c =35A		0.25	0.6		
		tr(i)	V _{GE} =±15V		0.1			
	Turn-off	toff	R _G =33Ω		0.45	1.0		
tf				0.08	0.3			
Forward on voltage	V _F	I _F =35A	chip	2.4		V		
			terminal	2.55	3.4			
Reverse recovery time of FRD	t _{rr}	I _F =35A			0.35	μs		
Brake	Zero gate voltage collector current	ICES	V _{CEs} =1400V, V _{GE} =0V		1.0	mA		
	Gate-Emitter leakage current	IGES	V _{CE} =0V, V _{GE} =±20V		0.2	μA		
	Collector-Emitter saturation voltage	V _{CE(sat)}	I _c =25A, V _{GE} =15V	chip	2.2		V	
				terminal	2.35	2.8		
	Turn-on time	ton	V _{CC} =800V		0.35	1.2	μs	
		tr	I _c =25A		0.25	0.6		
	Turn-off time	toff	V _{GE} =±15V		0.45	1.0		
		tf	R _G =51Ω		0.08	0.3		
	Reverse current	I _{RRM}	V _R =1400V			1.0	mA	
	Forward on voltage	V _{FM}	I _F =35A	chip	1.1		V	
terminal				1.2	1.5			
Reverse current	I _{RRM}	V _R =1600V			1.0	mA		
Resistance	R	T=25°C		5000		Ω		
		T=100°C	465	495	520			
B value	B	T=25/50°C	3305	3375	3450	K		

● Thermal resistance Characteristics

Item	Symbol	Condition	Characteristics			Unit
			Min.	Typ.	Max.	
Thermal resistance (1 device)	R _{th(j-c)}	Inverter IGBT			0.52	°C/W
		Inverter FWD			0.90	
		Brake IGBT			0.69	
		Converter Diode			0.75	
Contact thermal resistance	R _{th(c-f)}	With thermal compound		0.05		

* This is the value which is defined mounting on the additional cooling fin with thermal compound

■ Equivalent Circuit Schematic

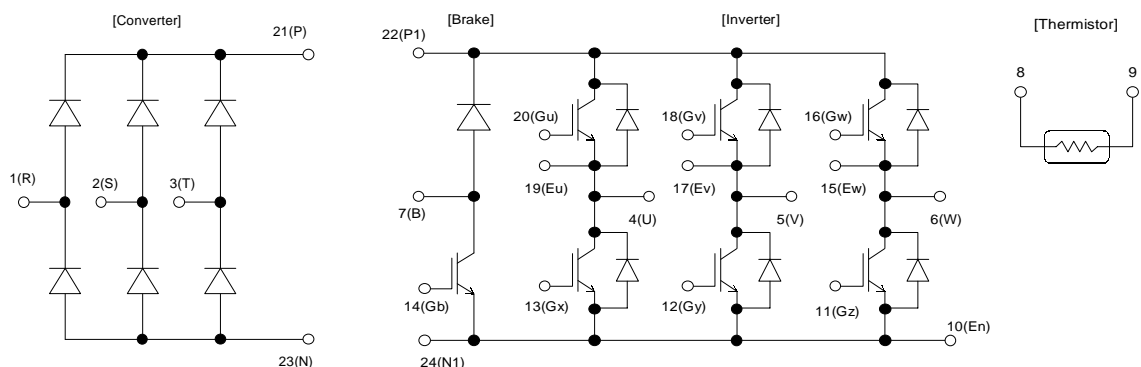

■ Characteristics (Representative)

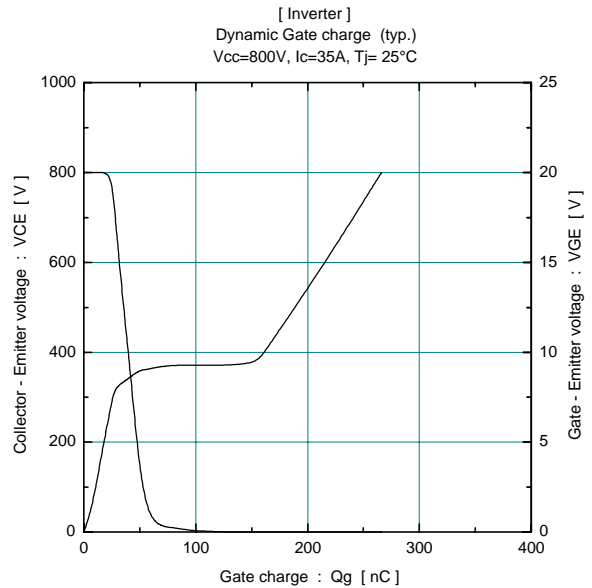
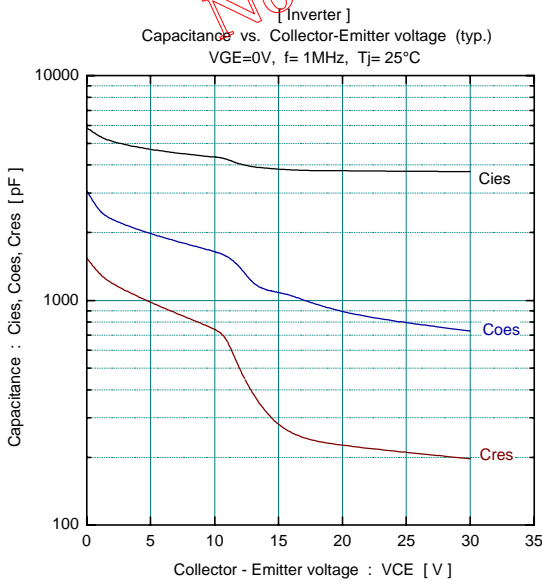
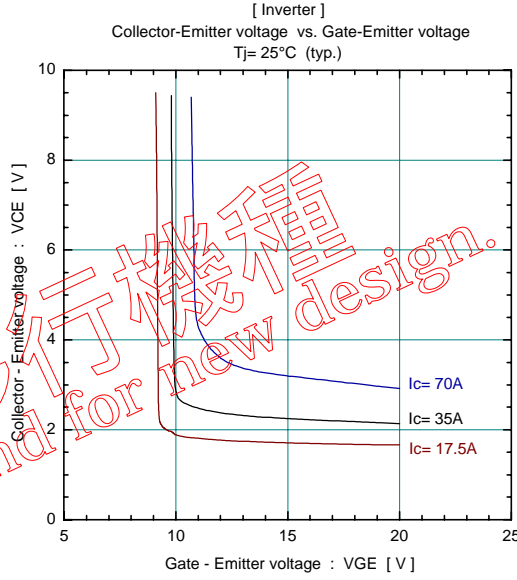
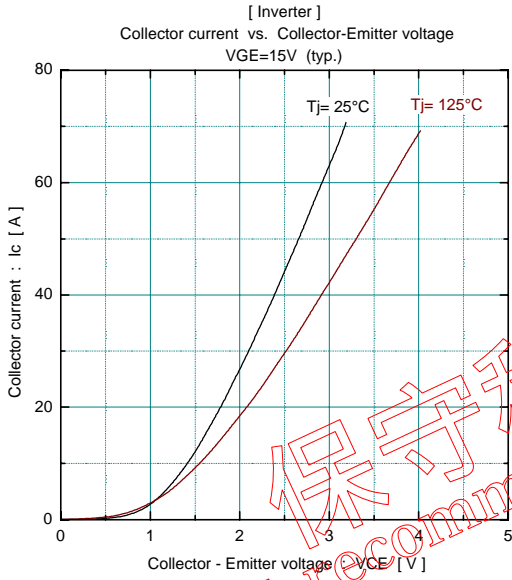
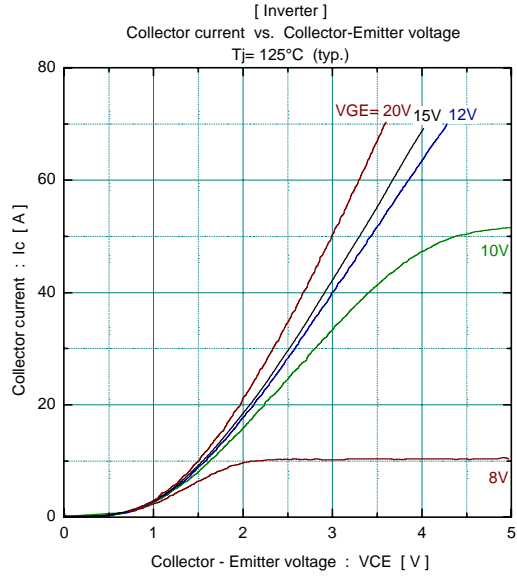
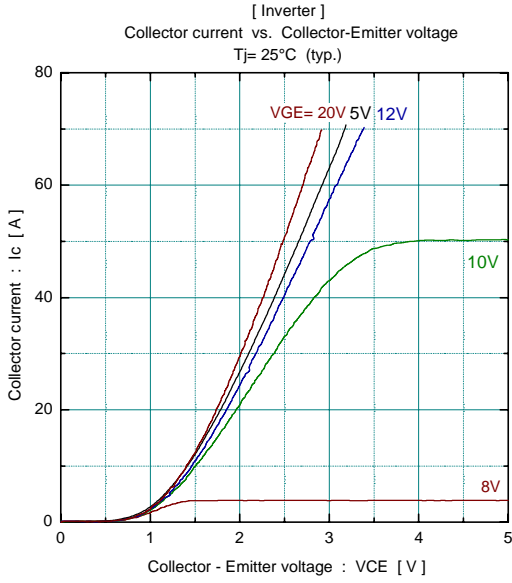

保守移行機種
Not recommend for new design.

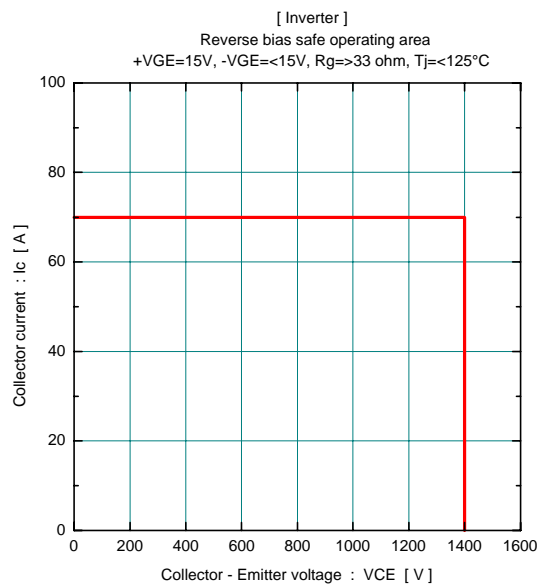
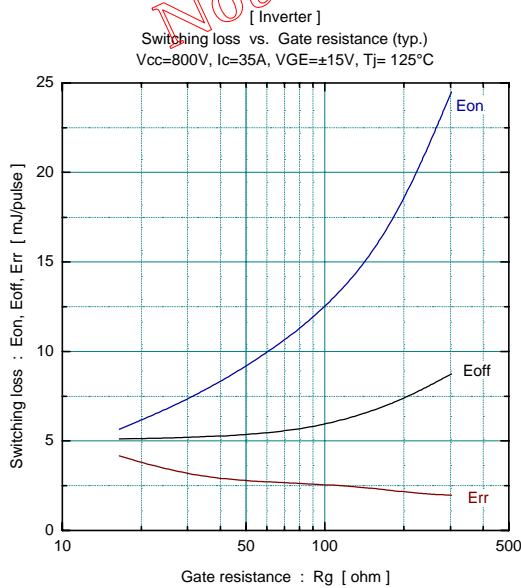
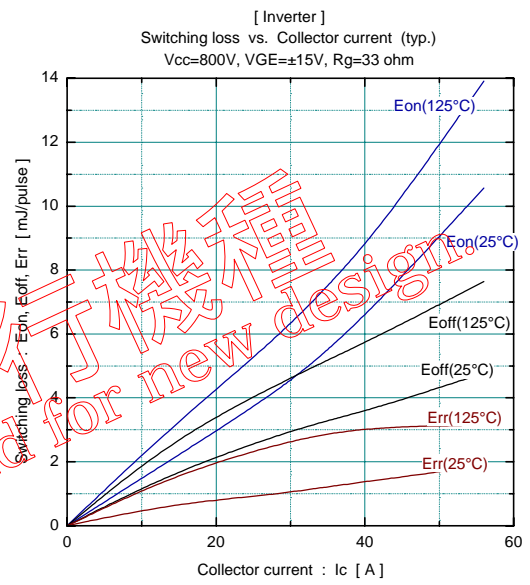
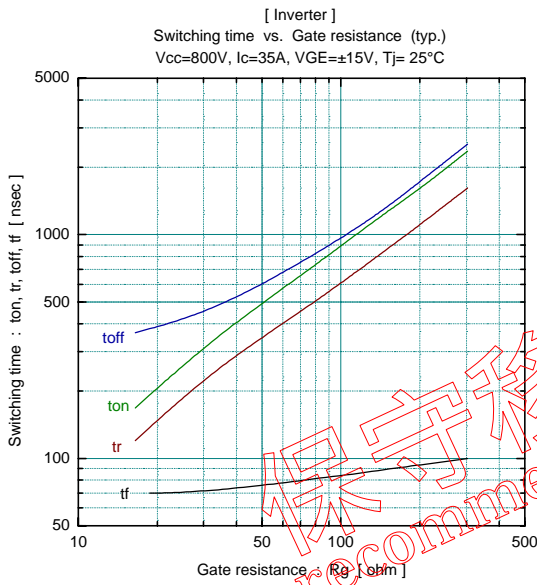
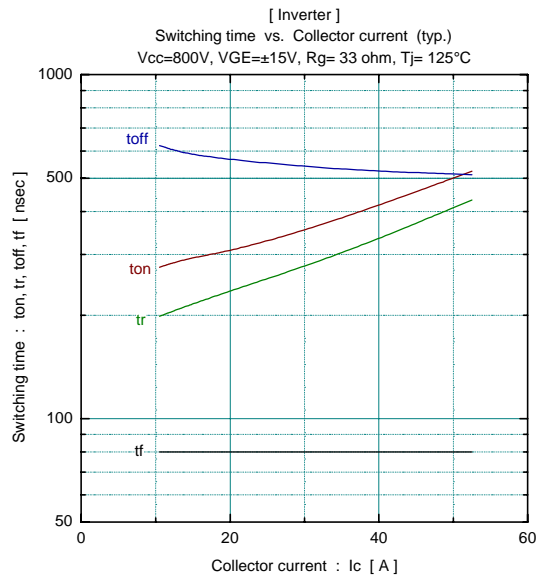
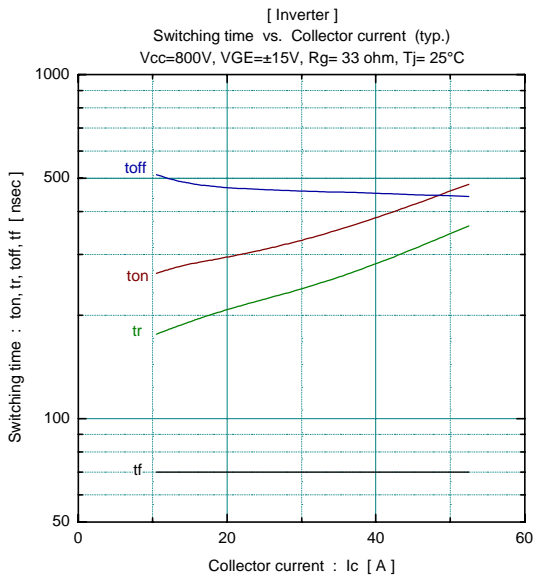

保守移行機種
 Not recommend for new design

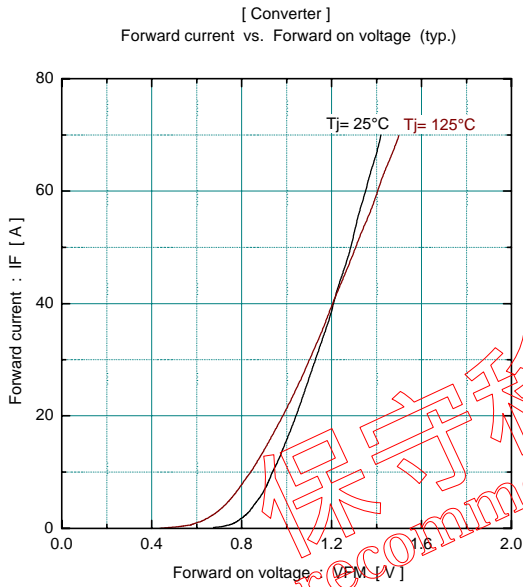
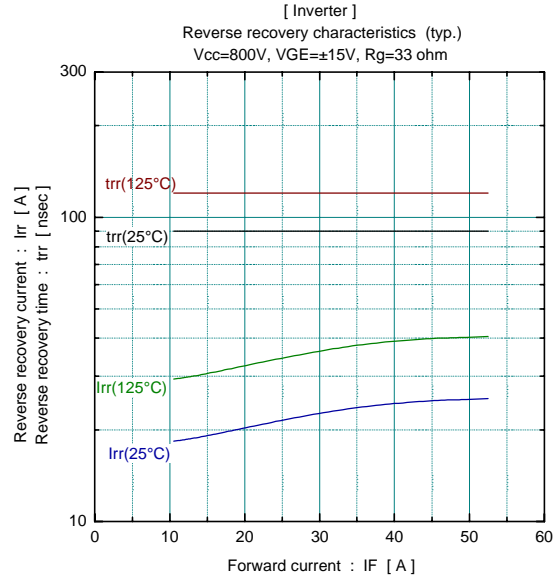
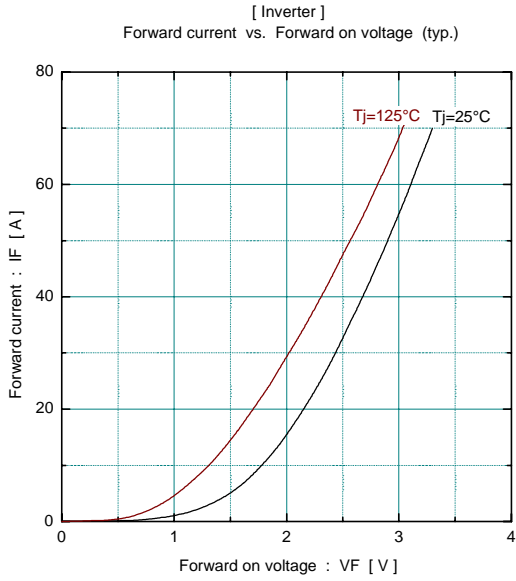

保守移行機種
Not recommend for new design.

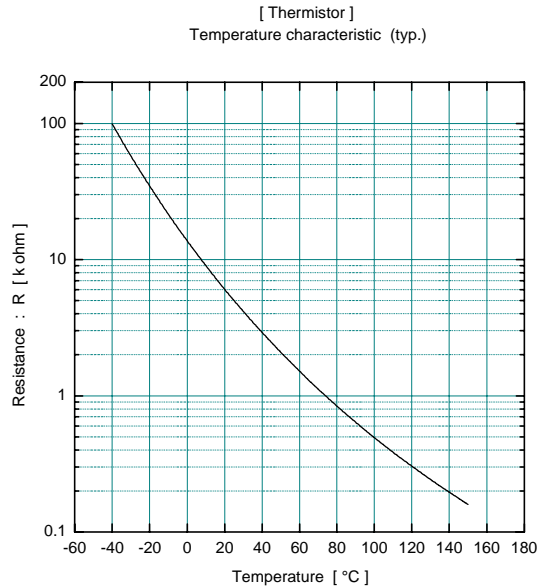
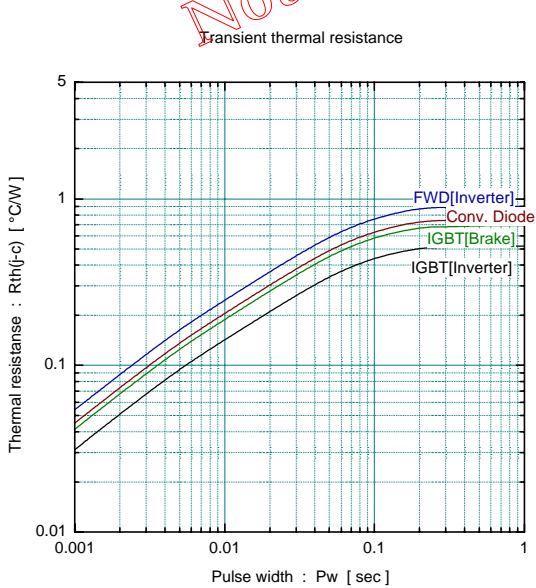

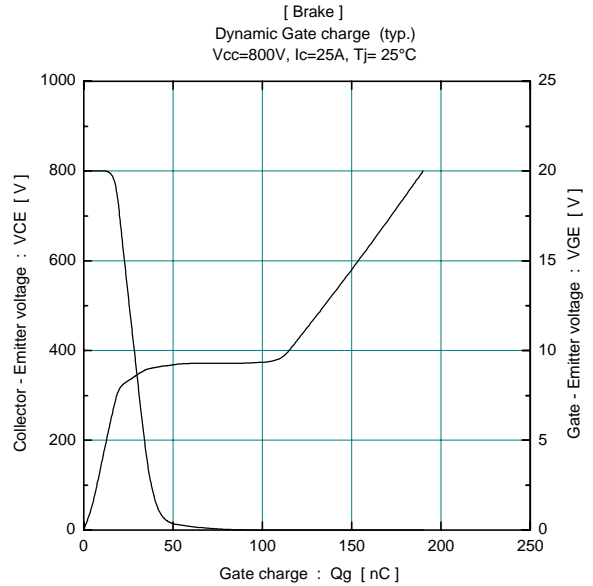
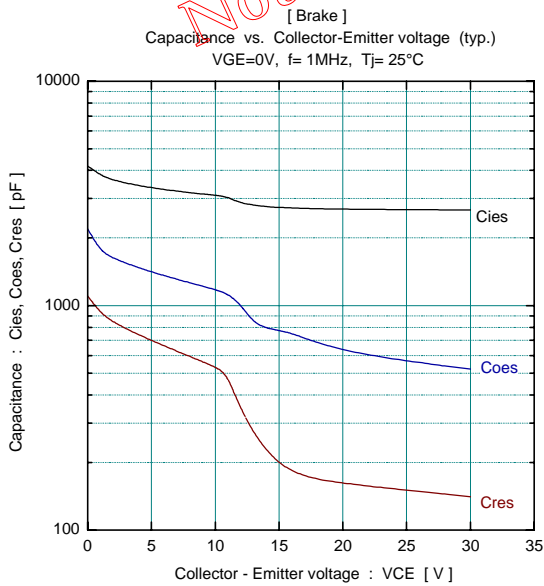
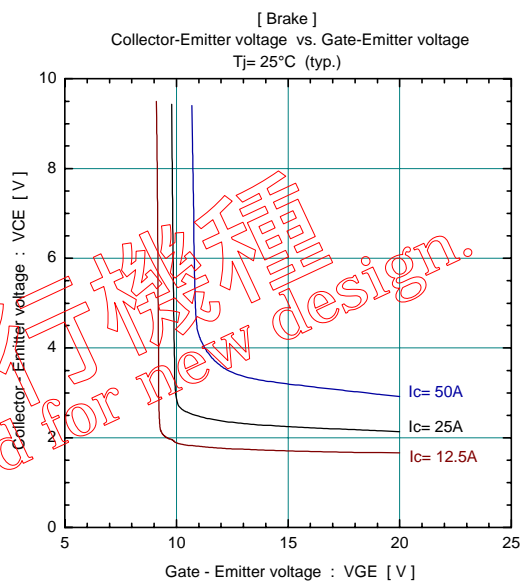
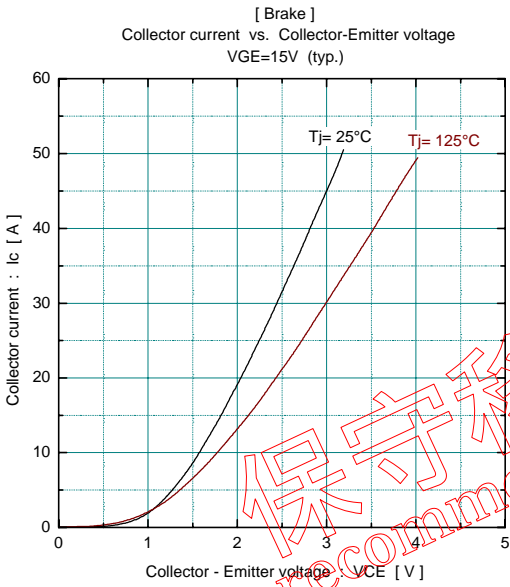
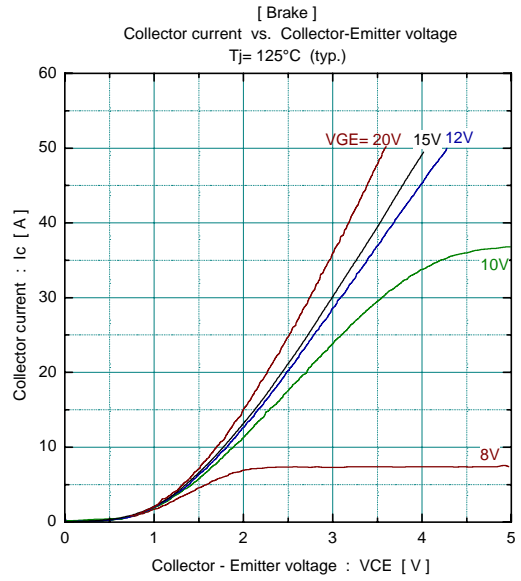
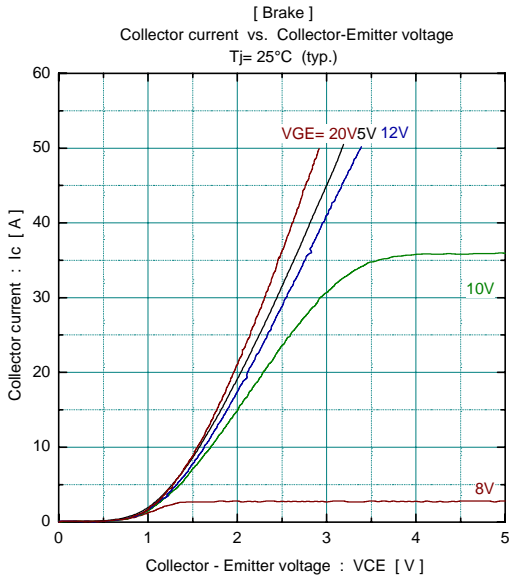

保守移行機種
Not recommend for new design.

Outline Drawings, mm

