

IGBT MODULE (U series) 1200V / 35A / PIM



■ Features

- Low $V_{CE(sat)}$
- Compact Package
- P.C. Board Mount Module
- Converter Diode Bridge Dynamic Brake Circuit

■ Applications

- Inverter for Motoe Drive
- AC and DC Servo Drive Amplifier
- Uninterruptible Power Supply

■ Maximum ratings and characteristics

● Absolute maximum ratings ($T_c=25^\circ\text{C}$ unless otherwise specified)

| Item | Symbol | Condition | Rating | Unit | | |
|---------------------------------|-------------------------------------|-----------|--------------------------------|------------------------|-----|----------------------|
| Inverter | Collector-Emitter voltage | V_{CES} | 1200 | V | | |
| | Gate-Emitter voltage | V_{GES} | ± 20 | V | | |
| | Collector current | I_c | Continuous | $T_c=25^\circ\text{C}$ | 35 | A |
| | | | | $T_c=80^\circ\text{C}$ | 25 | |
| | | I_{CP} | 1ms | $T_c=25^\circ\text{C}$ | 70 | |
| | | | | $T_c=80^\circ\text{C}$ | 50 | |
| $-I_c$ | | | 35 | | | |
| $-I_c$ pulse | 1ms | | 70 | | | |
| Collector power dissipation | P_c | 1 device | 160 | W | | |
| Brake | Collector-Emitter voltage | V_{CES} | 1200 | V | | |
| | Gate-Emitter voltage | V_{GES} | ± 20 | V | | |
| | Collector current | I_c | Continuous | $T_c=25^\circ\text{C}$ | 25 | A |
| | | | | $T_c=80^\circ\text{C}$ | 15 | |
| | | I_{CP} | 1ms | $T_c=25^\circ\text{C}$ | 50 | |
| | | | | $T_c=80^\circ\text{C}$ | 30 | |
| Collector power dissipation | P_c | 1 device | 115 | W | | |
| Repetitive peak reverse voltage | V_{RRM} | | 1200 | V | | |
| Converter | Repetitive peak reverse voltage | V_{RRM} | 1600 | V | | |
| | Average output current | I_o | 50Hz/60Hz sine wave | 35 | A | |
| | Surge current (Non-Repetitive) | I_{FSM} | $T_j=150^\circ\text{C}$, 10ms | 260 | A | |
| | I^2t (Non-Repetitive) | I^2t | half sine wave | | 338 | A^2s |
| | | | | | | |
| Operating junction temperature | T_j | | +150 | $^\circ\text{C}$ | | |
| Storage temperature | T_{stg} | | -40 to +125 | $^\circ\text{C}$ | | |
| Isolation voltage | between terminal and copper base *2 | V_{iso} | AC : 1 minute | AC 2500 | V | |
| | between thermistor and others *3 | | | AC 2500 | | |
| Mounting screw torque | | | 3.5 *1 | N·m | | |

*1 Recommendable value : 2.5 to 3.5 N·m (M5)

*2 All terminals should be connected together when isolation test will be done.

*3 Two thermistor terminals should be connected together, each other terminals should be connected together and shorted to base plate when isolation test will be done.

● Electrical characteristics (T_j=25°C unless otherwise specified)

| Item | Symbol | Condition | Characteristics | | | Unit | | | |
|-----------------------|--------------------------------------|--|---|-----------------------|----------|------|------|------|---|
| | | | Min. | Typ. | Max. | | | | |
| Inverter | Zero gate voltage collector current | ICES | V _{CE} =1200V, V _{GE} =0V | | - | 1.0 | mA | | |
| | Gate-Emitter leakage current | IGES | V _{CE} =0V, V _{GE} =±20V | | - | 200 | nA | | |
| | Gate-Emitter threshold voltage | V _{GE(th)} | V _{CE} =20V, I _C =35mA | | 4.5 | 6.5 | 8.5 | V | |
| | Collector-Emitter saturation voltage | V _{CE(sat)} (terminal) | V _{GE} =15V I _C =35A | T _J =25°C | - | 2.25 | 2.70 | V | |
| | | | | T _J =125°C | - | 2.60 | - | | |
| | | V _{CE(sat)} (chip) | | T _J =25°C | - | 1.95 | 2.40 | | |
| | | | | T _J =125°C | - | 2.30 | - | | |
| | Input capacitance | C _{ies} | V _{GE} =0V, V _{CE} =10V, f=1MHz | | - | 3 | - | nF | |
| | Turn-on time | t _{on} | V _{CC} =600V | | - | 0.53 | 1.20 | μs | |
| | | t _r | I _C =35A | | - | 0.43 | 0.60 | | |
| | | t _{r(i)} | V _{GE} =±15V | | - | 0.03 | - | | |
| | Turn-off time | t _{off} | R _G = 43 Ω | | - | 0.37 | 1.00 | μs | |
| | | t _f | | | - | 0.07 | 0.30 | | |
| Forward on voltage | V _F (terminal) | V _{GE} = 0 V I _F =35A | T _J =25°C | - | 2.05 | 2.40 | V | | |
| | | | T _J =125°C | - | 2.20 | - | | | |
| | V _F (chip) | | T _J =25°C | - | 1.75 | 2.10 | | | |
| | | | T _J =125°C | - | 1.90 | - | | | |
| Reverse recovery time | t _{rr} | I _F =35A | | - | - | 0.35 | μs | | |
| Brake | Zero gate voltage collector current | ICES | V _{CE} =1200V, V _{GE} =0V | | - | 1.0 | mA | | |
| | Gate-Emitter leakage current | IGES | V _{CE} =0V, V _{GE} =±20V | | - | 200 | nA | | |
| | Collector-Emitter saturation voltage | V _{CE(sat)} (terminal) | I _C =25A V _{GE} =15V | T _J =25°C | - | 2.40 | 2.90 | V | |
| | | | | T _J =125°C | - | 2.85 | - | | |
| | | V _{CE(sat)} (chip) | | T _J =25°C | - | 2.10 | 2.60 | | |
| | | | | T _J =125°C | - | 2.55 | - | | |
| | Turn-on time | t _{on} | V _{CC} =600V | | - | 0.53 | 1.20 | μs | |
| | | t _r | I _C =25A | | - | 0.43 | 0.60 | | |
| | Turn-off time | t _{off} | V _{GE} =±15V | | - | 0.37 | 1.00 | μs | |
| | | t _f | R _G = 68 Ω | | - | 0.07 | 0.30 | | |
| | Reverse current | I _{RRM} | V _R =1200V | | - | - | 1.0 | mA | |
| | Converter | Forward on voltage | V _{FM} | I _F =35 A | terminal | - | 1.35 | 1.70 | V |
| | | | | V _{GE} =0V | chip | - | 1.25 | - | |
| Reverse current | I _{RRM} | V _R =1600V | | - | - | 1.0 | mA | | |
| Thermistor | Resistance | R | T=25°C | - | 5000 | - | Ω | | |
| | | | T=100°C | 465 | 495 | 520 | | | |
| B value | B | T=25/50°C | | 3305 | 3375 | 3450 | K | | |

● Thermal resistance Characteristics

| Item | Symbol | Condition | Characteristics | | | Unit |
|---------------------------------|----------------------|-----------------------|-----------------|------|------|------|
| | | | Min. | Typ. | Max. | |
| Thermal resistance (1 device) | R _{th(j-c)} | Inverter IGBT | - | - | 0.76 | °C/W |
| | | Inverter FWD | - | - | 1.19 | |
| | | Brake IGBT | - | - | 1.07 | |
| | | Converter Diode | - | - | 0.90 | |
| Contact thermal resistance * | R _{th(c-f)} | With thermal compound | - | 0.05 | - | |

* This is the value which is defined mounting on the additional cooling fin with thermal compound

■ Equivalent Circuit Schematic

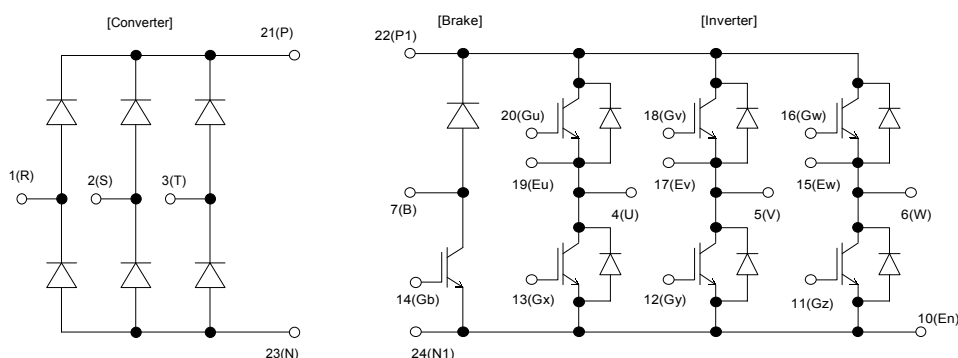

■ Characteristics (Representative)

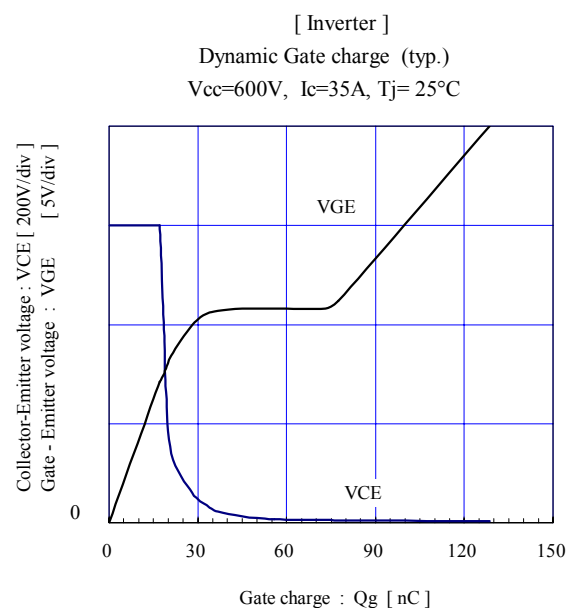
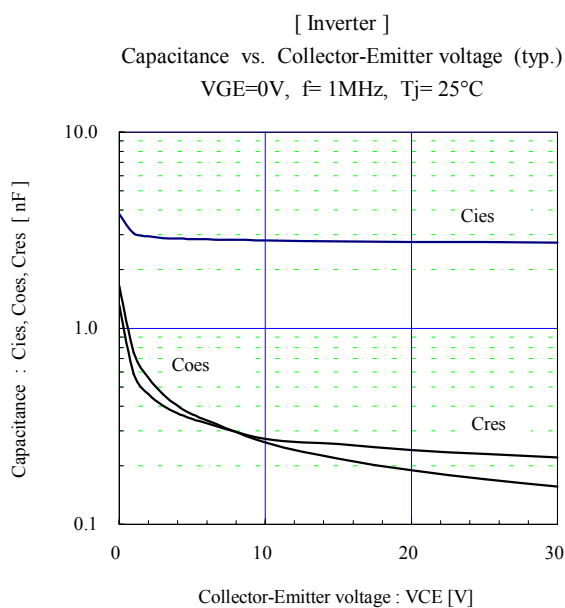
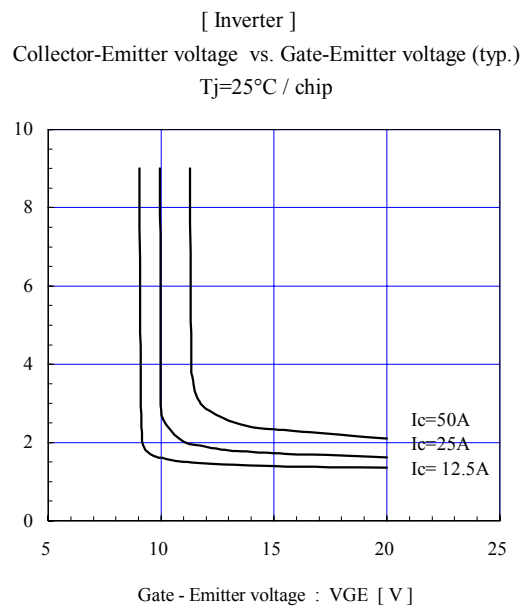
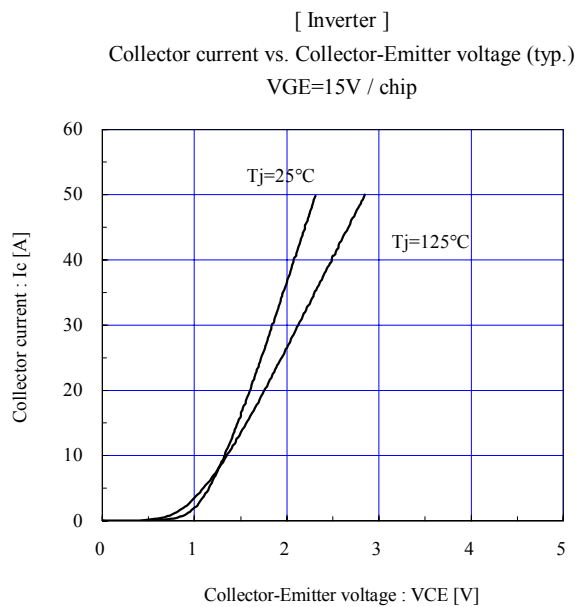
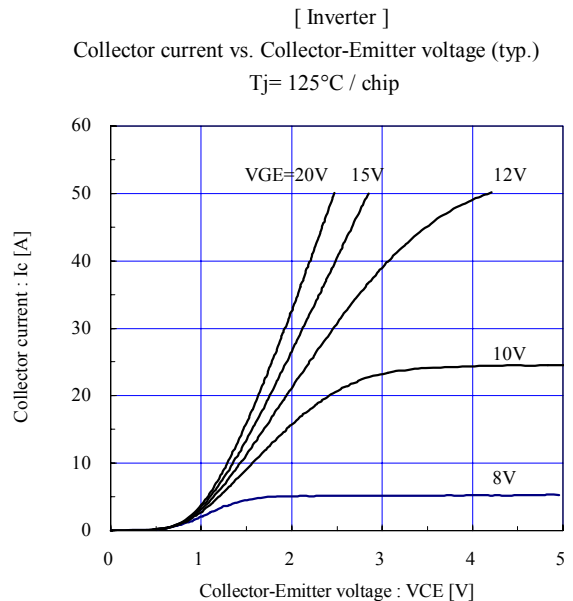
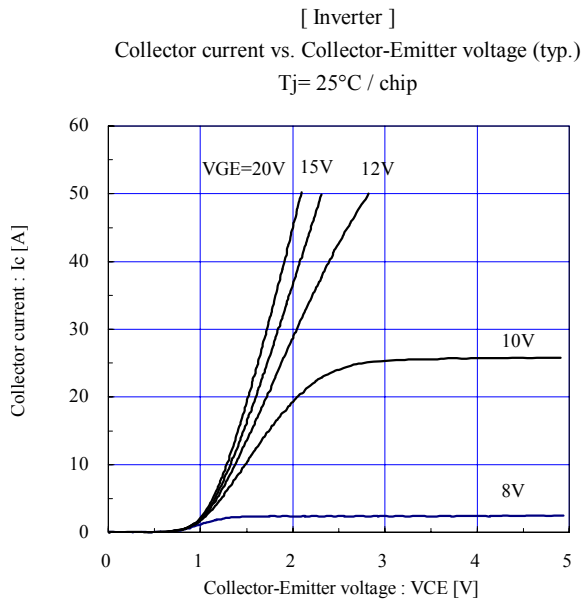

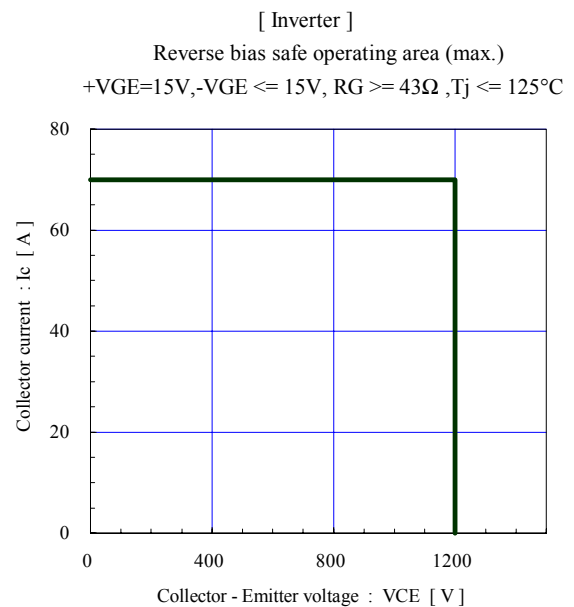
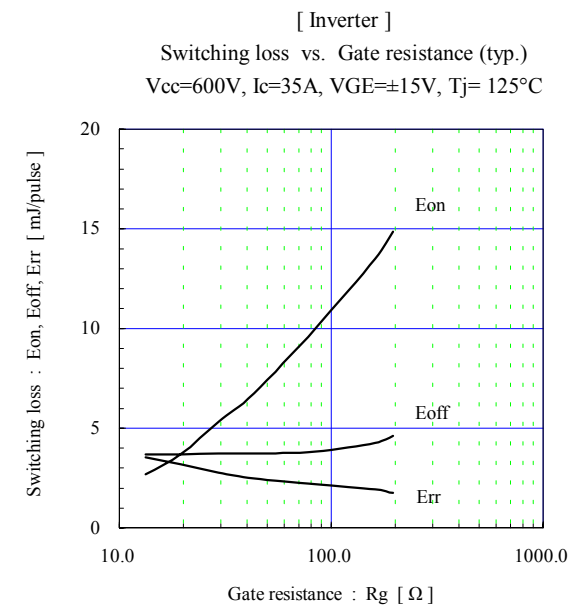
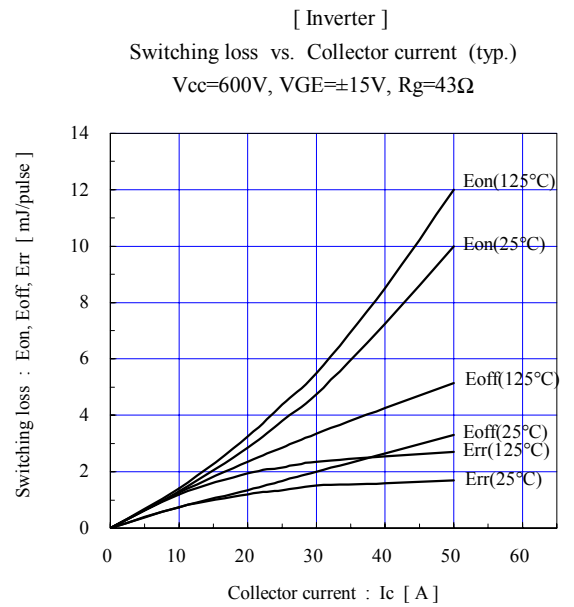
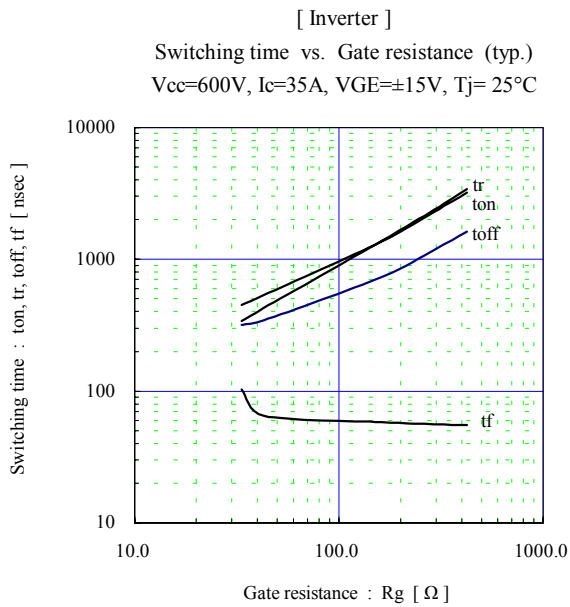
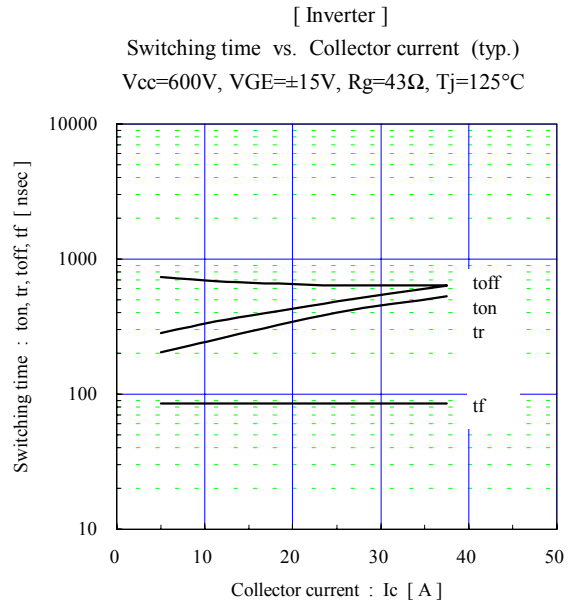
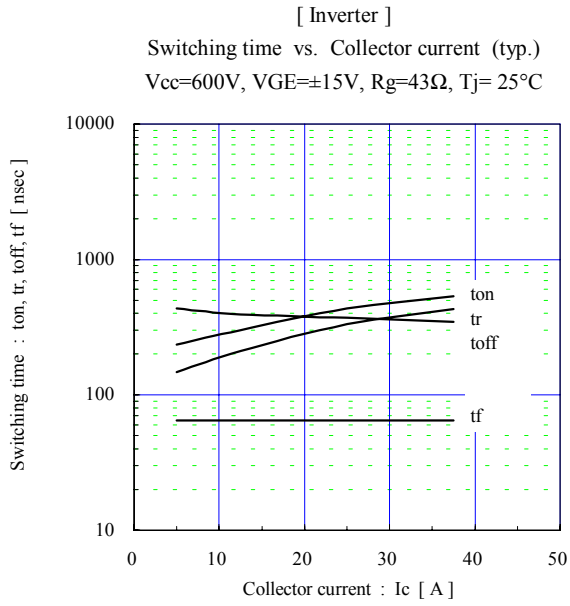

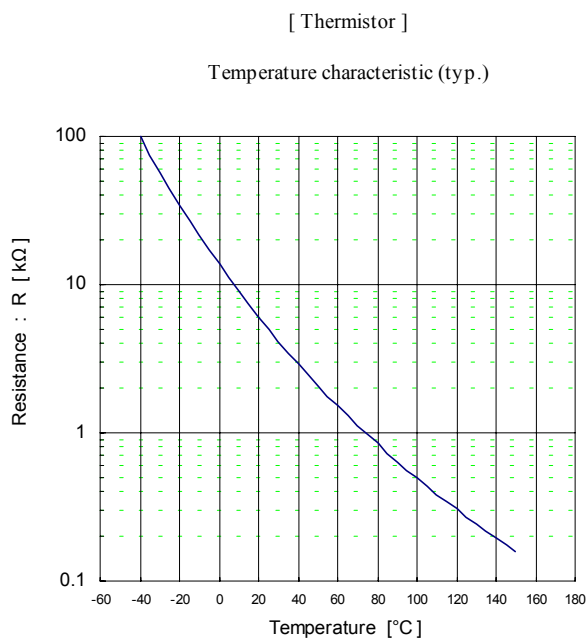
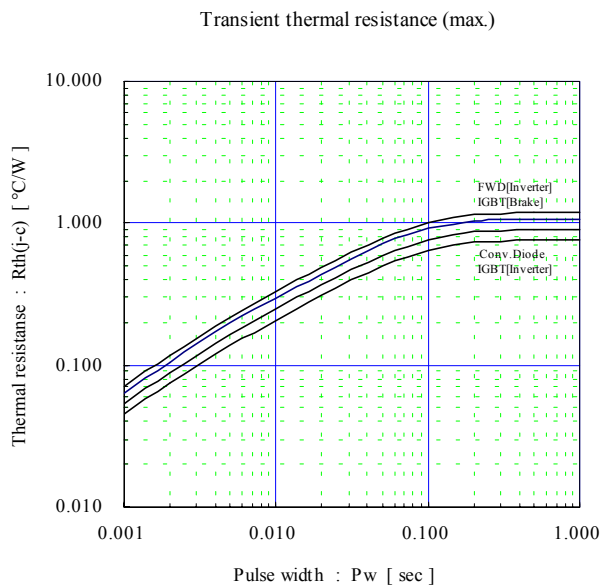
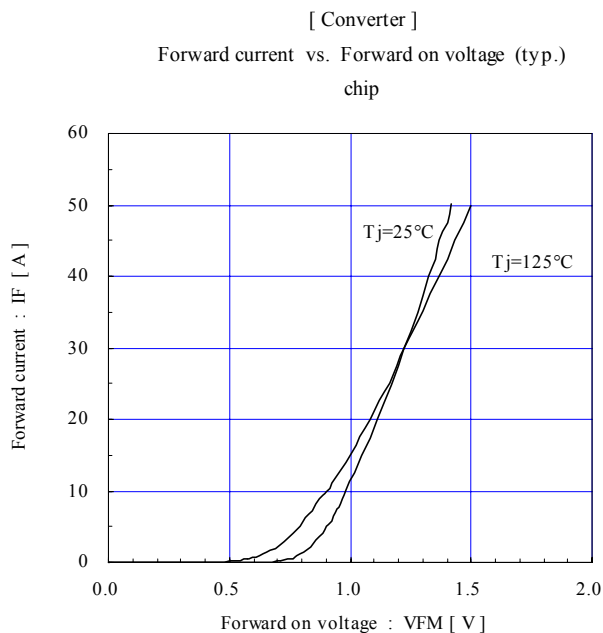
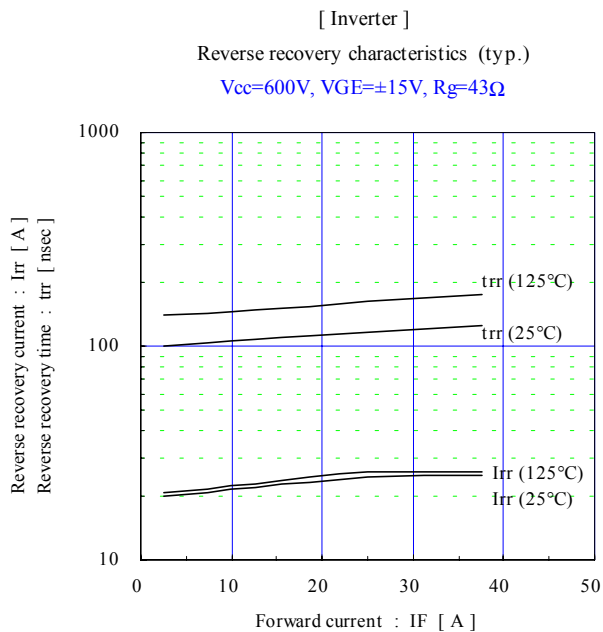
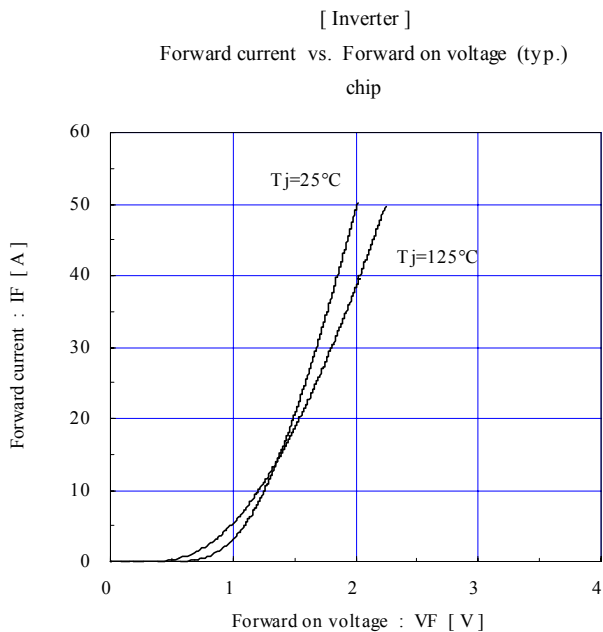

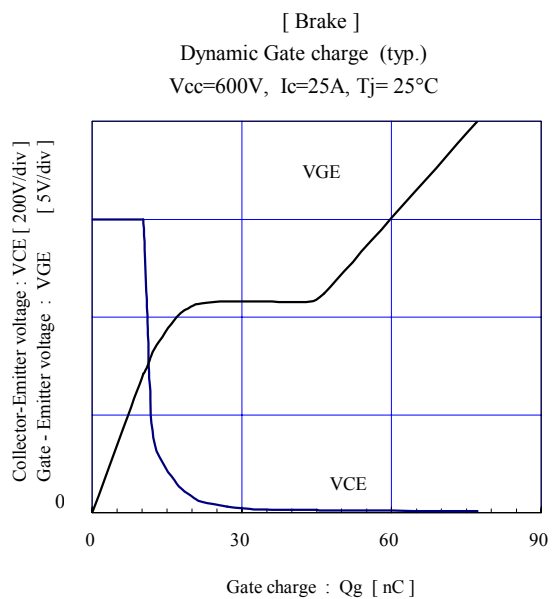
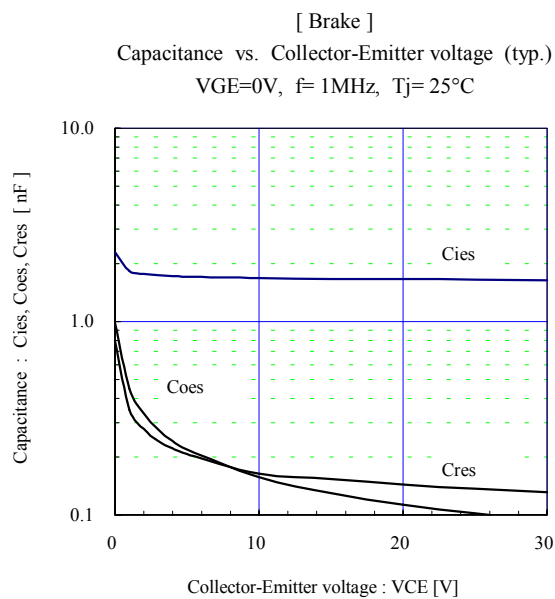
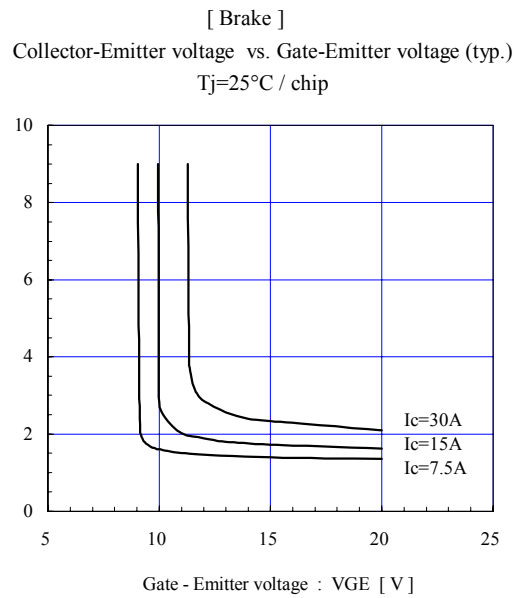
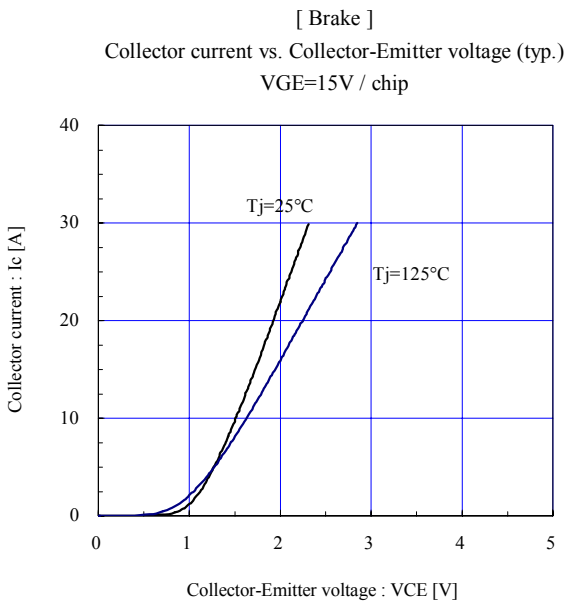
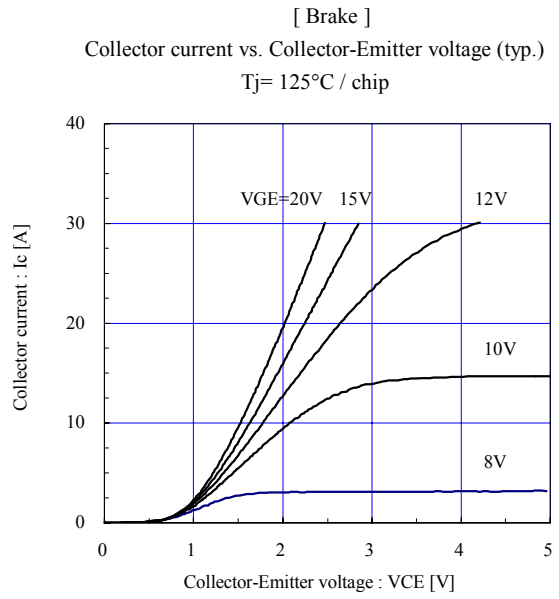
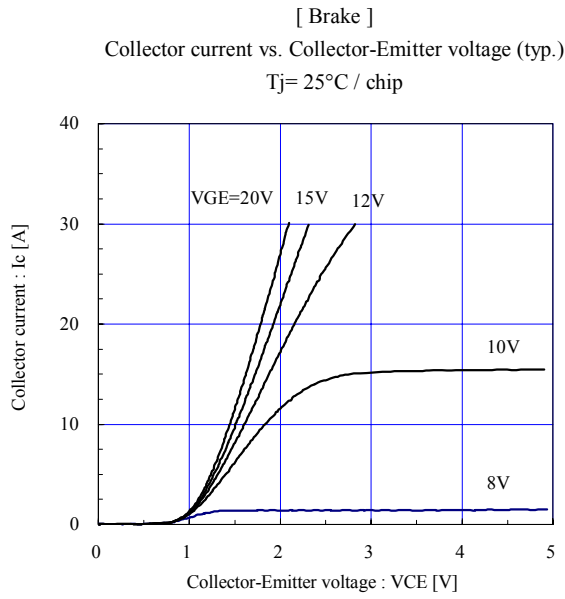

■ Outline Drawings, mm

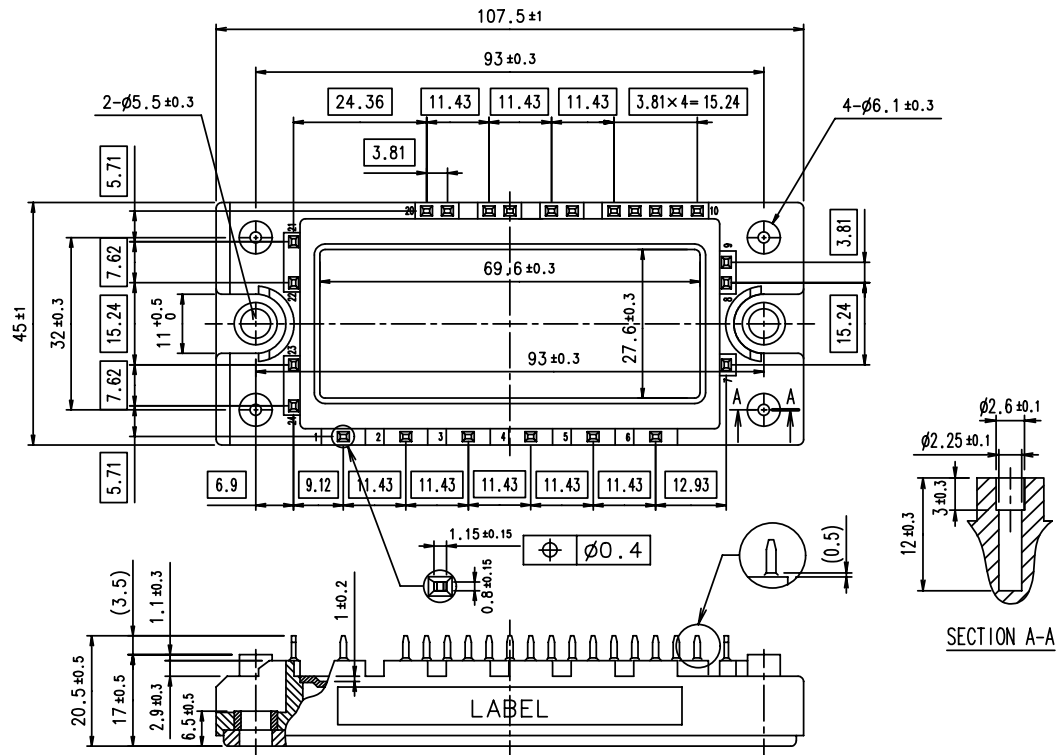

□ shows theoretical dimension.
 () shows reference dimension.