

## LOW LOSS SUPER HIGH SPEED RECTIFIER

## Outline drawings, mm

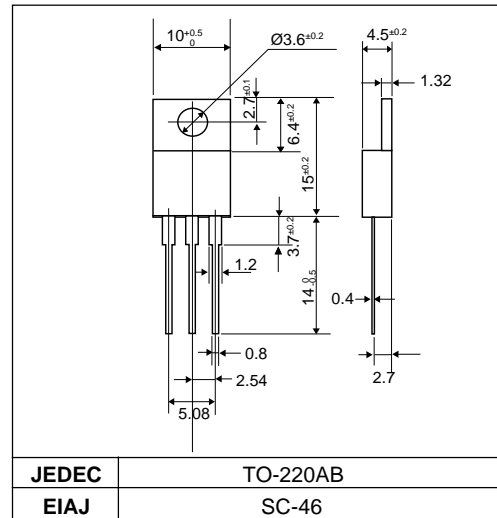

## Features

- Low  $V_F$
- Super high speed switching
- High reliability by planer design

## Applications

- High speed power switching

## Maximum ratings and characteristics

- Absolute maximum ratings

Item	Symbol	Conditions	Rating	Unit
Repetitive peak reverse voltage	$V_{RRM}$		200	V
Average output current	$I_o$	Square wave, duty=1/2, $T_c=120^\circ\text{C}$	5*	A
Surge current	$I_{FSM}$	Sine wave 10ms	25	A
Operating junction temperature	$T_j$		-40 to +150	$^\circ\text{C}$
Storage temperature	$T_{stg}$		-40 to +150	$^\circ\text{C}$

\* Average forward current of centertap full wave connection

- Electrical characteristics ( $T_a=25^\circ\text{C}$  Unless otherwise specified)

Item	Symbol	Conditions	Max.	Unit
Forward voltage drop	$V_{FM}$	$I_{FM}=2.5\text{A}$	0.95	V
Reverse current	$I_{RRM}$	$V_R=V_{RRM}$	100	$\mu\text{A}$
Reverse recovery time	$t_{rr}$	$I_F=0.1\text{A}$ , $I_R=0.2\text{A}$ , $I_{rec}=0.05\text{A}$	35	ns
Thermal resistance	$R_{th(j-c)}$	Junction to case	5.0*	$^\circ\text{C}/\text{W}$

## Connection diagram

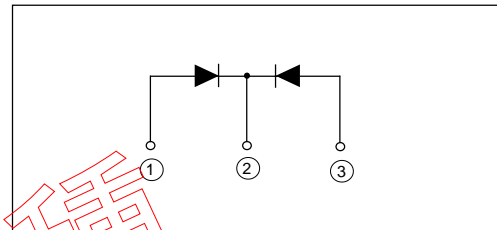

Characteristics

Forward Characteristic (typ.)

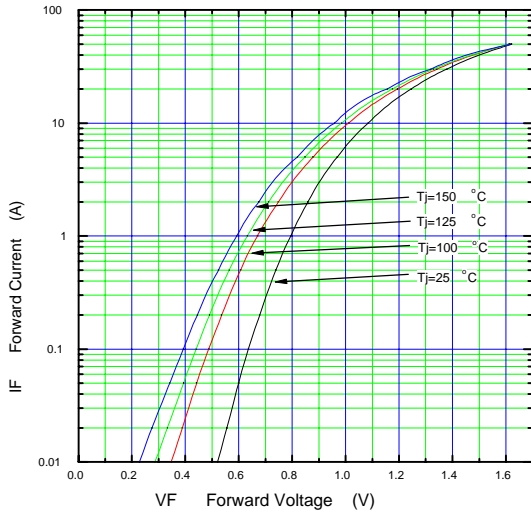

Reverse Characteristic (typ.)

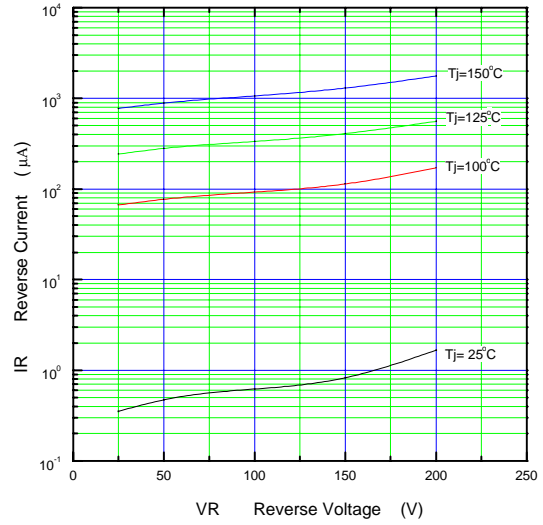

Forward Power Dissipation

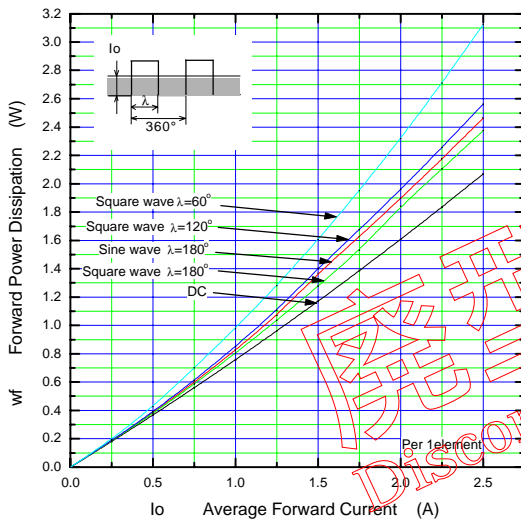

Reverse Power Dissipation

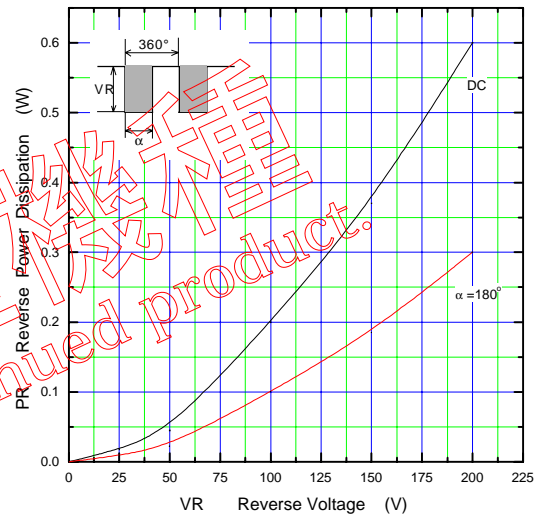

Current Derating ( $I_o$ - $T_c$ )

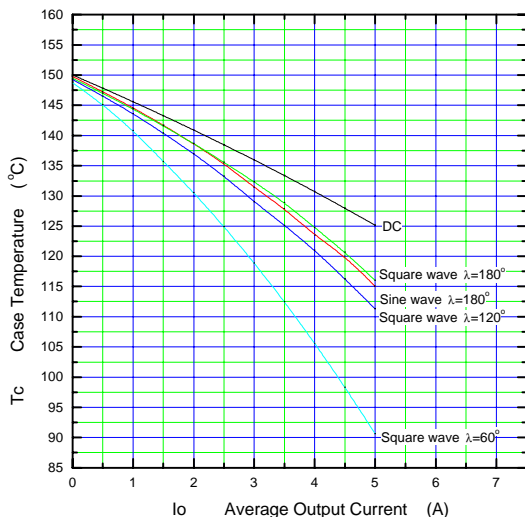

Junction Capacitance Characteristic (typ.)

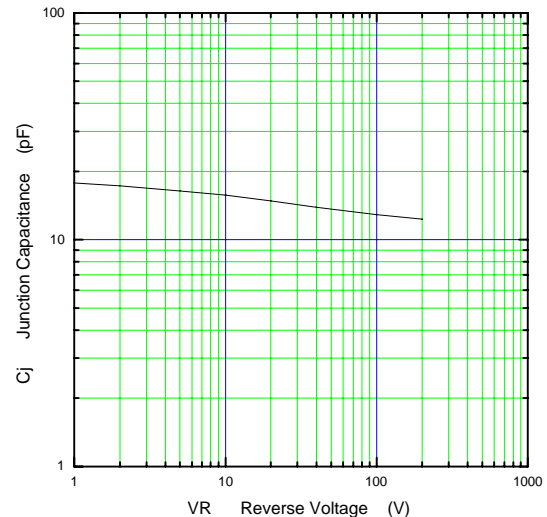

$\lambda$ : Conduction angle of forward current for each rectifier element  
 $I_o$ : Output current of center-tap full wave connection

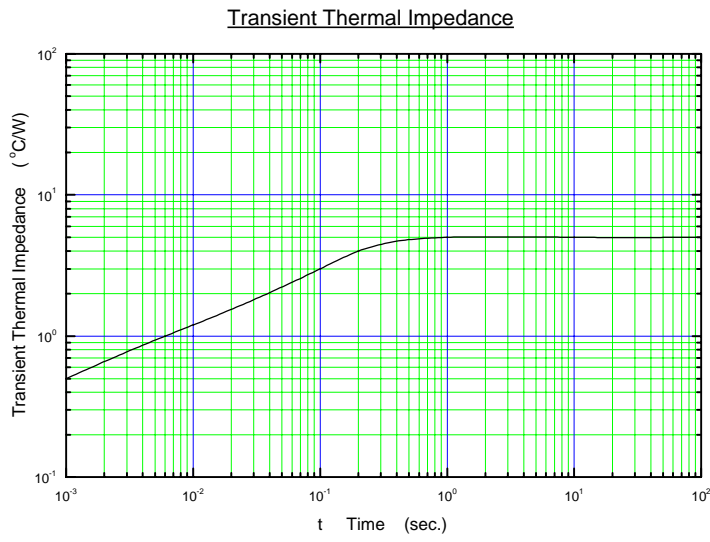

廢型機種  
Discontinued product.