

# ESAD92M-03R (20A)

( 300V / 20A )

## LOW LOSS SUPER HIGH SPEED RECTIFIER

## Outline drawings, mm

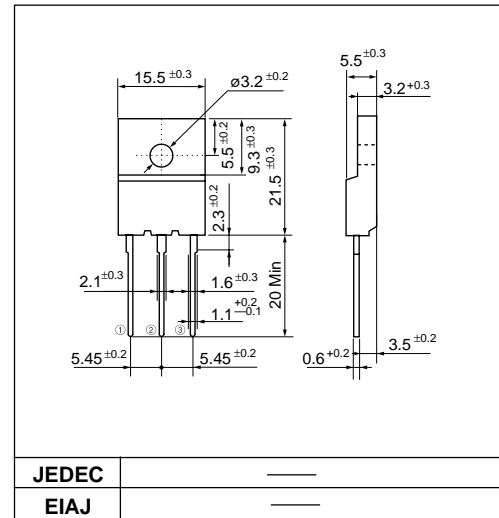

## Features

- Insulated package by fully molding
- Low  $V_F$
- Super high speed switching
- High reliability by planer design

## Applications

- High speed power switching

## Maximum ratings and characteristics

- Absolute maximum ratings

Item	Symbol	Conditions	Rating	Unit
Repetitive peak reverse voltage	$V_{RRM}$		300	V
Non-Repetitive peak reverse voltage	$V_{RSM}$		300	V
Isolating voltage	$V_{iso}$	Terminals-to-case, AC, 1 min.	1500	V
Average output current	$I_o$	Square wave, duty=1/2, $T_c=96^\circ\text{C}$	20*	A
Surge current	$I_{FSM}$	Sine wave 10ms	80	A
Operating junction temperature	$T_j$		-40 to +150	$^\circ\text{C}$
Storage temperature	$T_{stg}$		-40 to +150	$^\circ\text{C}$

\*Average forward current of centertap full wave connection

- Electrical characteristics ( $T_a=25^\circ\text{C}$  Unless otherwise specified)

Item	Symbol	Conditions	Max.	Unit
Forward voltage drop	$V_{FM}$	$I_{FM}=10\text{A}$	1.2	V
Reverse current	$I_{RRM}$	$V_R=V_{RRM}$	200	$\mu\text{A}$
Reverse recovery time	$t_{rr}$	$I_F=0.1\text{A}$ , $I_R=0.2\text{A}$ , $I_{rec}=0.05\text{A}$	40	ns
Thermal resistance	$R_{th(j-c)}$	Junction to case	2.0*	$^\circ\text{C/W}$

■ Characteristics

Forward characteristics

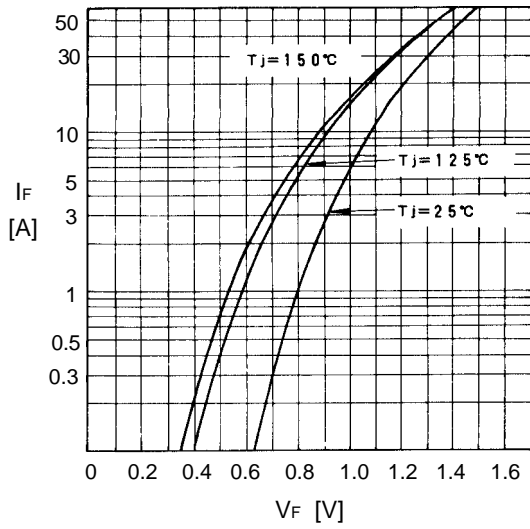

Reverse characteristics

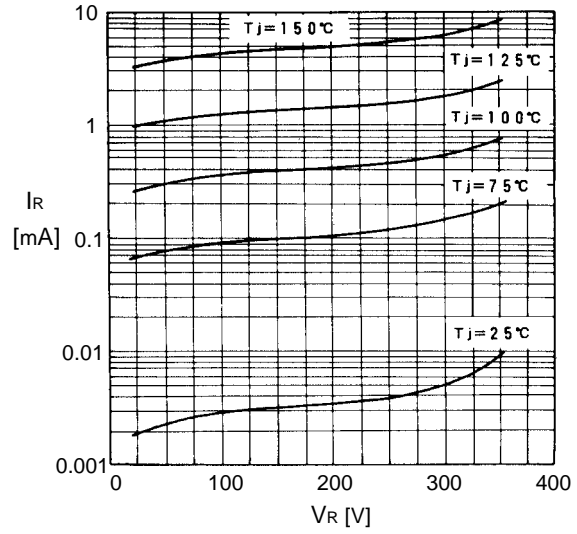

Forward power dissipation

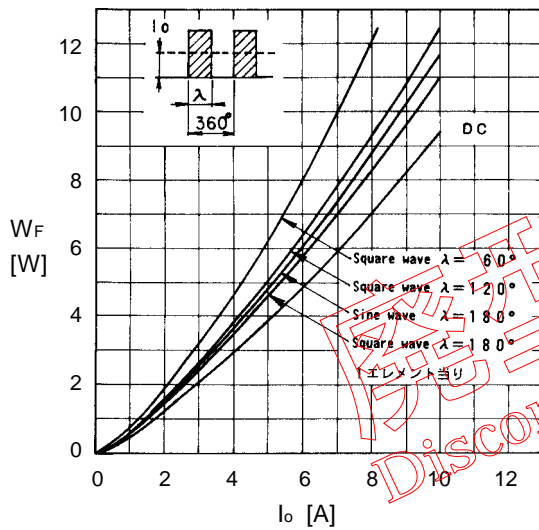

Reverse power dissipation

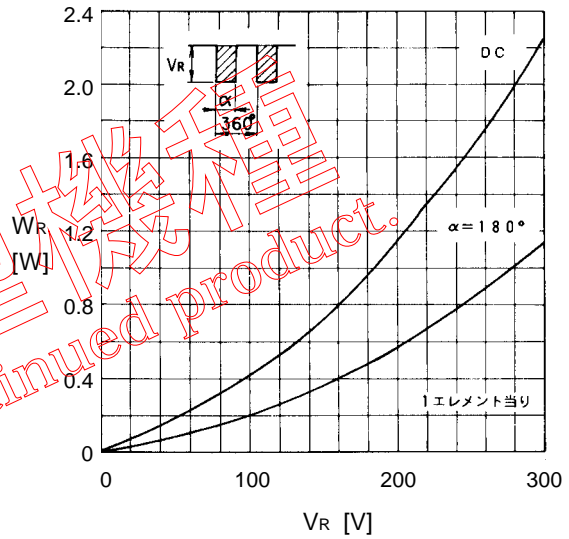

Output current-case temperature

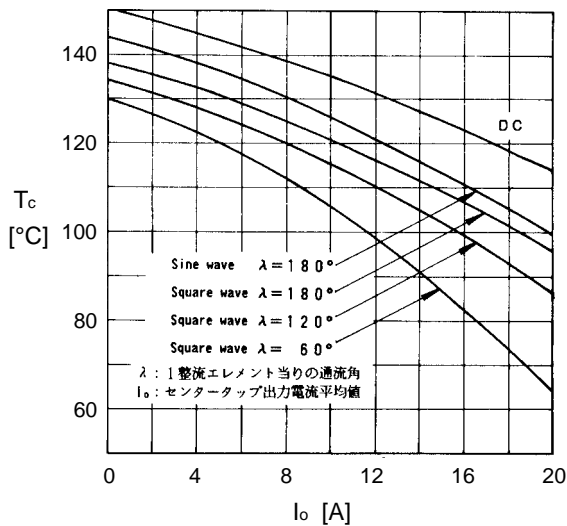

Junction capacitance characteristics

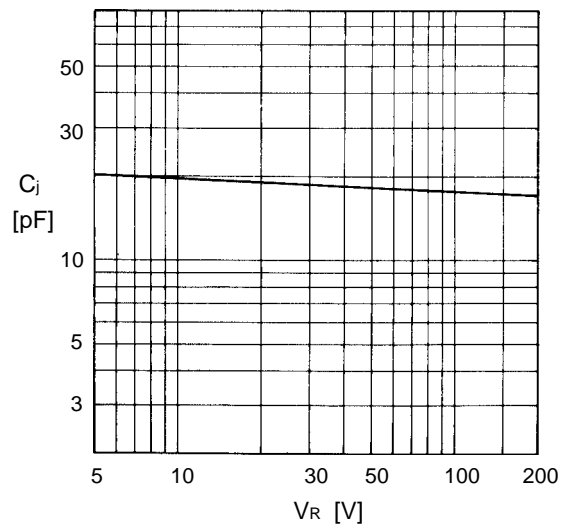

Surge capability

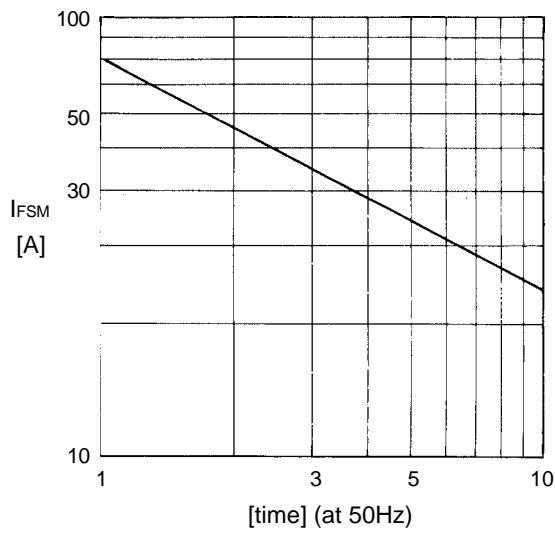

Transient thermal impedance

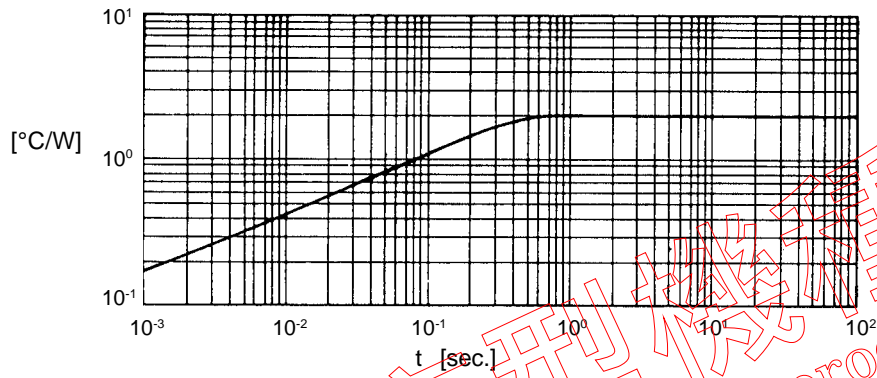

廢型機  
Discontinued product.