

■ Description

FA3675F is a control IC for 6-channel DC-DC converter. This IC can directly drive a Nch/Pch-MOSFET. This IC is suitable to reduce converter size because it has many functions in a small package LQFP-48.

■ Features

- 6-channel PWM control with MOSFET direct driving :
5-channel for Pch-MOSFET, 1 channel for Nch-MOSFET
- Low input voltage: 2.5V to 20V
- $\pm 1.0\%$ high accuracy bandgap reference
- Low power consumption by means of CDMOS
Standby mode: 20 μ A(max.)
Operating mode: 10mA(max.)
- Soft start function for each channel
- ON/OFF function for each channel
- Timer latch for short protection
- Undervoltage lockout
- Wide range of operation frequency: 50kHz to 1MHz
- Package: LQFP-48(Thin and small)

■ Application

- VTR-camera, digital-steel-camera and portable equipment

■ Dimensions, mm

● LQFP-48

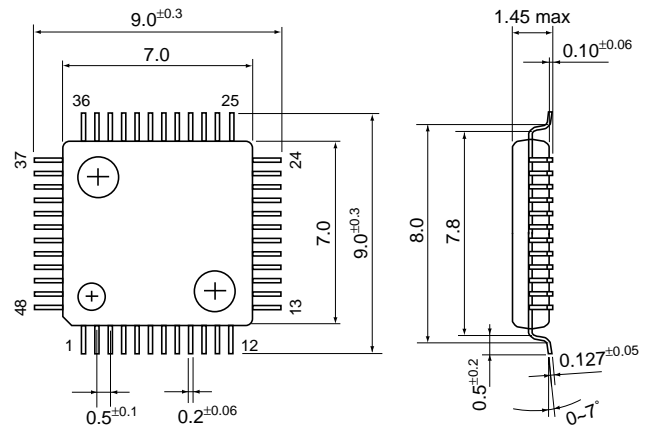

廃型機種
Discontinued product.

■ Block diagram

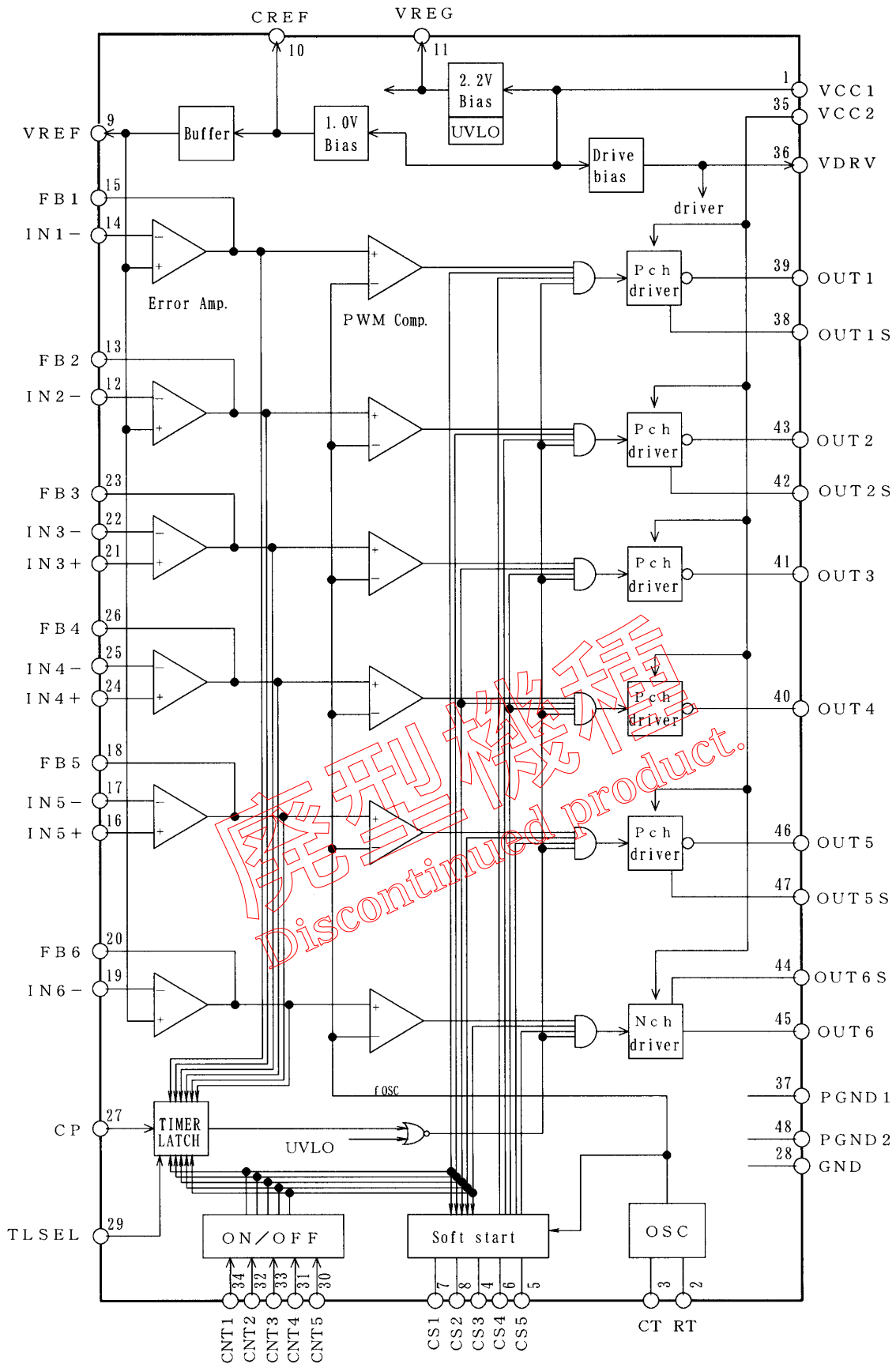

Pin No.	Pin symbol	Description
1	VCC1	Power supply for control circuit
2	RT	Oscillator timing resistor
3	CT	Oscillator timing capacitor
4	CS3	Soft start for Ch. 3 & Ch. 4
5	CS5	Soft start for Ch. 6
6	CS4	Soft start for Ch. 5
7	CS1	Soft start for Ch. 1
8	CS2	Soft start for Ch. 2
9	VREF	Reference voltage output
10	CREF	Capacitor for reference voltage output
11	VREG	Regulated voltage output
12	IN2-	Ch. 2 inverting input to error amplifier
13	FB2	Ch. 2 output of error amplifier
14	IN1-	Ch. 1 inverting input to error amplifier
15	FB1	Ch. 1 output of error amplifier
16	IN5+	Ch. 5 non-inverting input to error amplifier
17	IN5-	Ch. 5 inverting input to error amplifier
18	FB5	Ch. 5 output of error amplifier
19	IN6-	Ch. 6 inverting input to error amplifier
20	FB6	Ch. 6 output of error amplifier
21	IN3+	Ch. 3 non-inverting input to error amplifier
22	IN3-	Ch. 3 inverting input to error amplifier
23	FB3	Ch. 3 output of error amplifier
24	IN4+	Ch. 4 non-inverting input to error amplifier

Pin No.	Pin symbol	Description
25	IN4-	Ch. 4 inverting input to error amplifier
26	FB4	Ch. 4 output of error amplifier
27	CP	Timing capacitor for timer latch delay
28	GND	Ground
29	TLSEL	Ch. 3 & Ch. 4 timer latch selection (Low: disable)
30	CNT5	Ch. 6 ON/OFF function
31	CNT4	Ch. 5 ON/OFF function
32	CNT2	Ch. 2 ON/OFF function
33	CNT3	Ch. 3 & Ch. 4 ON/OFF function
34	CNT1	Ch. 1 ON/OFF function
35	VCC2	Power supply for output stage
36	VDRV	Bias for logic circuit of outputs
37	PGND1	Power ground
38	OUT1S	Ch. 1 source electrode of output stage
39	OUT1	Ch. 1 output (for Pch-MOSFET)
40	OUT4	Ch. 4 output (for Pch-MOSFET)
41	OUT3	Ch. 3 output (for Pch-MOSFET)
42	OUT2S	Ch. 2 source electrode of output stage
43	OUT2	Ch. 2 output (for Pch-MOSFET)
44	OUT6S	Ch. 6 source electrode of output stage
45	OUT6	Ch. 6 output (for Nch-MOSFET)
46	OUT5	Ch. 5 output (for Pch-MOSFET)
47	OUT5S	Ch. 5 source electrode of output stage
48	PGND2	Power ground

■ Absolute maximum ratings

Item	Symbol	Rating	Unit
Power supply voltage	V _{CC}	20.0	V
Source peak current	I _{OUT}	-200	mA
Sink peak current	I _{OUT}	200	mA
Input voltage for analog input	V _{ANA}	-0.3 to +2.5	V
Input voltage for logic input	V _{LOG}	-0.3 to V _{CC} +0.5 (V _{CC} ≤ 5.0V) -0.3 to +5.5 (V _{CC} > 5.0V)	V
Total power dissipation *	P _d	550	mW
Junction temperature	T _J	125	°C
Ambient temperature	T _{OP}	-20 to +85	°C
Storage temperature	T _{stg}	-40 to +150	°C

* T_a < 25°C

■ Recommended operating conditions

Item	Symbol	Min.	Max.	Unit
Power supply voltage	V _{CC}	2.5	18.0	V
Input voltage for logic input	V _{LOG}	0.0	V _{CC} +0.25	V
		0.0	5.25	
Oscillation frequency	f _{OSC}	50	1000	kHz
Oscillator timing resistor	R _T	6.8	100	kΩ
Oscillator timing capacitor	C _T	22	1000	pF
CREF terminal by-pass capacitor	C _{REF}	0.01		μF

■ Electrical characteristics (Ta=25°C, Vcc1=Vcc2=6V, CT=100pF, RT=10kΩ)

Reference voltage section

Item	Symbol	Test condition	Min.	Typ.	Max.	Unit
Output voltage	VREF	No load	0.99	1.00	1.01	V
Load regulation	VRFLD	No load to RL=15kΩ		7	15	mV
Line regulation	VRFLIN	VCC=2.5 to 18V		3	10	mV
Output voltage variation due to temperature change	VRTa	Ta=-20 to +85°C		±0.5	±1.0	%

Regulated voltage section

Item	Symbol	Test condition	Min.	Typ.	Max.	Unit
Output voltage	VREG	No load	2.134	2.20	2.266	V
Load regulation	VRG LOD	No load to RL=3.9kΩ		2	10	mV
Line regulation	VRG LIN	VCC=2.5 to 18V		6	20	mV
Output voltage variation due to temperature change	VRGTa	Ta=-20 to +85°C		±0.5	±1.0	%

Oscillator section

Item	Symbol	Test condition	Min.	Typ.	Max.	Unit
Oscillation frequency	fosc	RT=10kΩ, CT=100pF	432	480	528	kHz
Frequency variation due to supply voltage change	fδV	VCC=2.5 to 18V		±1	±3	%
Frequency variation due to temperature change	fδT	Ta=-20 to +25°C Ta=+25 to +85°C		±3 ±7	±6 ±14	%

Error amplifier section

Item	Symbol	Test condition	Min.	Typ.	Max.	Unit
Input offset voltage	VIOF			2	10	mV
Input common mode voltage range	VICOM		0.2		1.5	V
Open-loop gain	AVOL		70	75		dB
Unity-gain bandwidth	ft			1.0		MHz
Output sink current	IFBL	VFB=VREF+0.05V	2.5	3.5		mA
Output source current	IFBH	VFB=VREF-0.05V		-0.18	-0.14	mA

Soft-start circuit section 1 (CS1, CS2, CS3)

Item	Symbol	Test condition	Min.	Typ.	Max.	Unit
Input threshold voltage	Vcso	Duty cycle=0%	0.36	0.46	0.56	V
	Vcs100	Duty cycle=100%	1.11	1.31	1.51	V
Charge current	Ics	Vcs=0V	-7.5	-5.0	-2.5	μA

Soft-start circuit section 2 (CS4, CS5)

Item	Symbol	Test condition	Min.	Typ.	Max.	Unit
Input threshold voltage	Vcso	Duty cycle=0%	0.36	0.46	0.56	V
	Vcs100	Duty cycle=100%	1.11	1.31	1.51	V
Charge current	Ics			0		μA

Short-circuit protection section

Item	Symbol	Test condition	Min.	Typ.	Max.	Unit
Threshold voltage at CP	V _{CP} TH		1.39	1.64	1.89	V
Charge current at CP	I _{CP}		-3.0	-1.9	-1.0	μA
Threshold voltage at error amplifier output	V _{FB} TL		1.36	1.56	1.76	V

ON/OFF logic input section

Item	Symbol	Test condition	Min.	Typ.	Max.	Unit
Input voltage for ON mode	V _{DH}	V _{CC} ≤5.0V	1.0		V _{CC} +0.25	V
		V _{CC} >5.0V	1.0		5.25	
Input voltage for OFF mode	V _{DL}		0		0.4	V

Undervoltage lockout circuit section

Item	Symbol	Test condition	Min.	Typ.	Max.	Unit
OFF to ON threshold voltage	V _{UV} VCC		1.52	1.72	1.92	V
Voltage hysteresis	ΔV _{UV} C			0.1		V

Output section 1 (OUT1)

Item	Symbol	Test condition	Min.	Typ.	Max.	Unit
L-level ON resistance	R _{ONL}	I _O =10mA, OUT1S:GND		6	10	Ω
H-level ON resistance	R _{ONH}	I _O =-10mA, OUT1S:GND		6	10	Ω
Rise time	t _r	C _{LOAD} =1000pF, OUT1S:GND		30	50	ns
Fall time	t _f	C _{LOAD} =1000pF, OUT1S:GND		60	85	ns
Sink current	I _{OUT}	OUT1S:R _{S1} =68Ω to GND	9	12	15	mA

Output section 2 (OUT2, OUT5)

Item	Symbol	Test condition	Min.	Typ.	Max.	Unit
L-level ON resistance	R _{ONL}	I _O =10mA OUT2S, OUT5S:GND		10	15	Ω
H-level ON resistance	R _{ONH}	I _O =-10mA OUT2S, OUT5S:GND		10	15	Ω
Rise time	t _r	C _{LOAD} =1000pF OUT2S, OUT5S:GND		40	60	ns
Fall time	t _f	C _{LOAD} =1000pF OUT2S, OUT5S:GND		70	95	ns
Sink current	I _{OUT}	OUT2S, OUT5S: R _{S2} , R _{S5} =68Ω to GND	8	11	14	mA

Output section 3 (OUT3, OUT4)

Item	Symbol	Test condition	Min.	Typ.	Max.	Unit
L-level ON resistance	R _{ONL}	I _O =10mA		10	15	Ω
H-level ON resistance	R _{ONH}	I _O =-10mA		10	15	Ω
Rise time	t _r	C _{LOAD} =1000pF		40	60	ns
Fall time	t _f	C _{LOAD} =1000pF		70	95	ns

Output section 4 (OUT6)

Item	Symbol	Test condition	Min.	Typ.	Max.	Unit
L-level ON resistance	R _{ONL}	I _O =10mA, OUT6S:VCC2		10	15	Ω
H-level ON resistance	R _{ONH}	I _O =-10mA, OUT6S:VCC2		10	15	Ω
Rise time	t _r	C _{LOAD} =1000pF, OUT6S:VCC2		40	60	ns
Fall time	t _f	C _{LOAD} =1000pF, OUT6S:VCC2		70	95	ns
Source current	I _{OUT}	OUT6S:R _{S6} =330Ω to VCC2 V _{CC} =7V	-14	-11	-8	mA

Overall device

Item	Symbol	Test condition	Min.	Typ.	Max.	Unit
Standby current	I _{CCO}			12	20	μA
Operating-state supply current	I _{CC}	Duty cycle=0%, R _L =∞		4	6	mA

■ Characteristic curves (Ta = 25°C)

Oscillation frequency (fosc) vs. timing resistor resistance (RT)

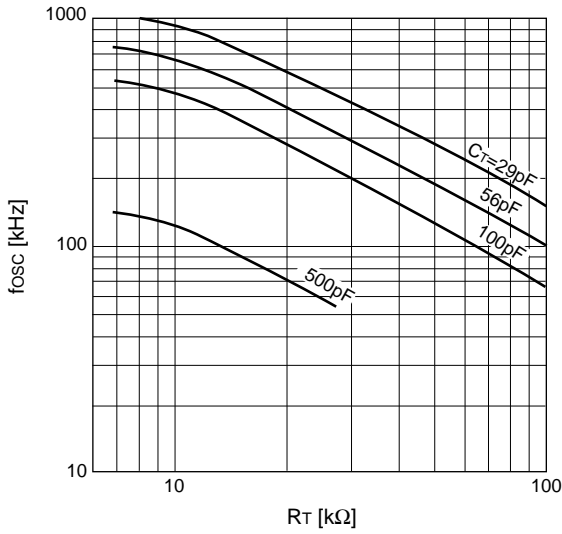

Oscillation frequency (fosc) vs. ambient temperature (Ta)

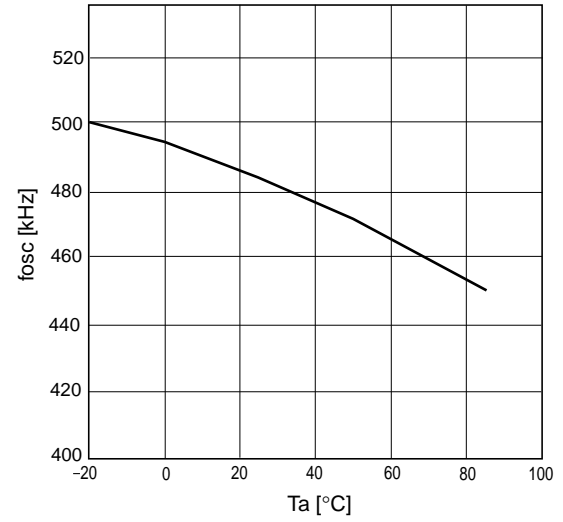

Output duty cycle vs. CS terminal voltage (Vcs)

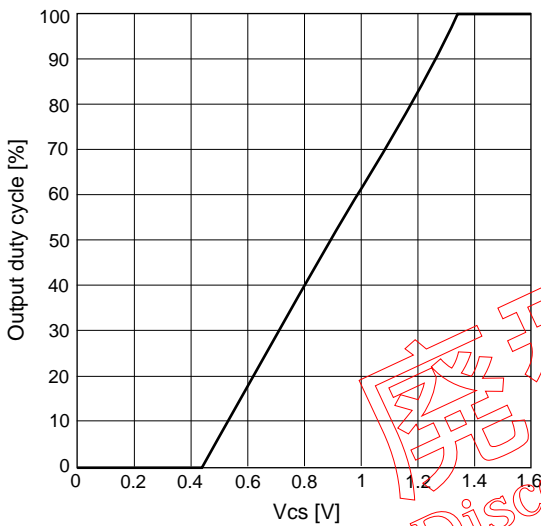

Output duty cycle vs. FB terminal voltage (VFB)

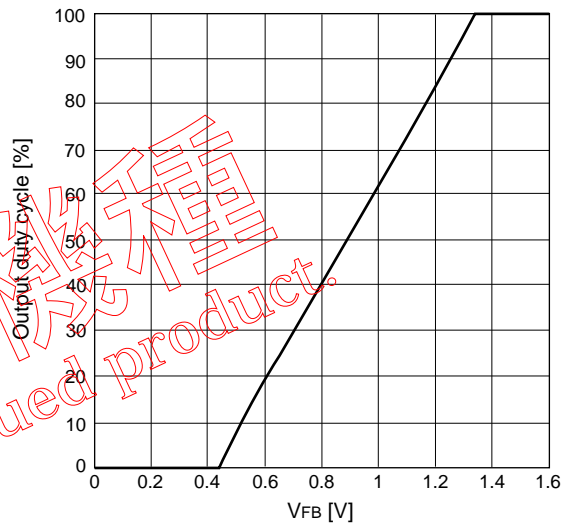

Reference voltage (VREF) vs ambient temperature (Ta)

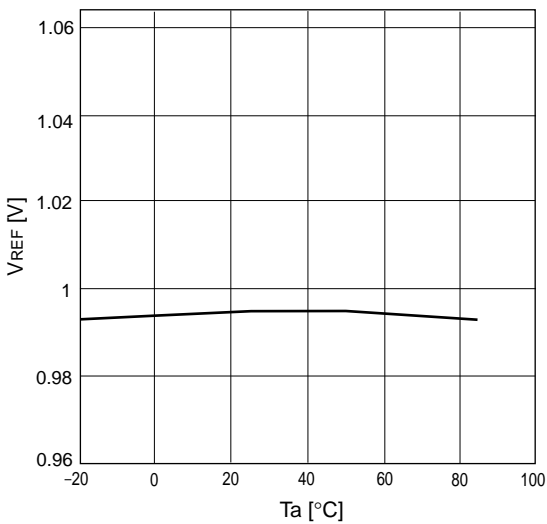

Supply current (Icc) vs supply voltage (Vcc)

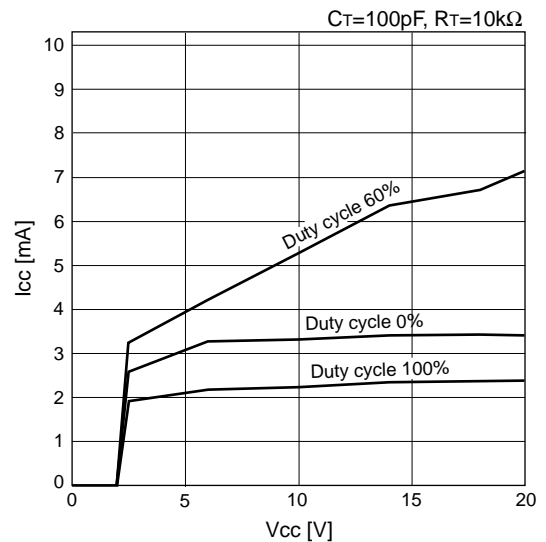

H-level output voltage ($V_{CC}-V_{OH}$) vs. output source current (I_{SOURCE}) for OUT1

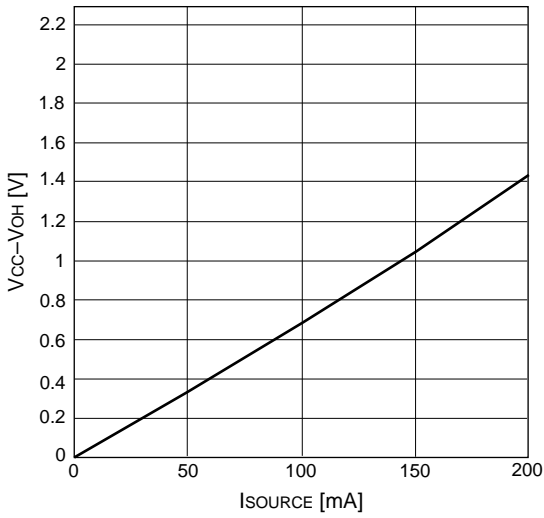

L-level output voltage (V_{OL}) vs. output sink current (I_{SINK}) for OUT1

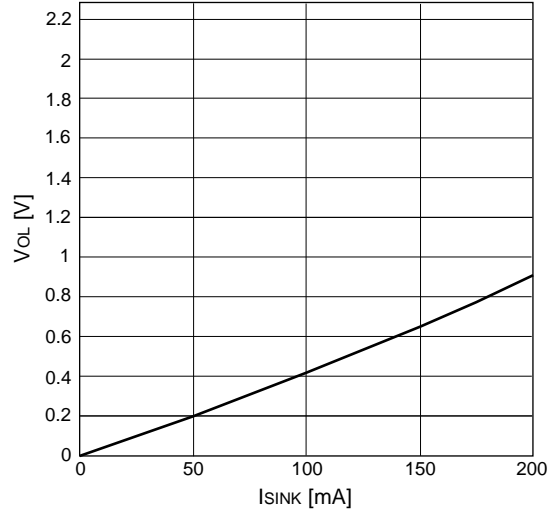

H-level output voltage ($V_{CC}-V_{OH}$) vs. output source current (I_{SOURCE}) for OUT2, 3, 4, 5, 6

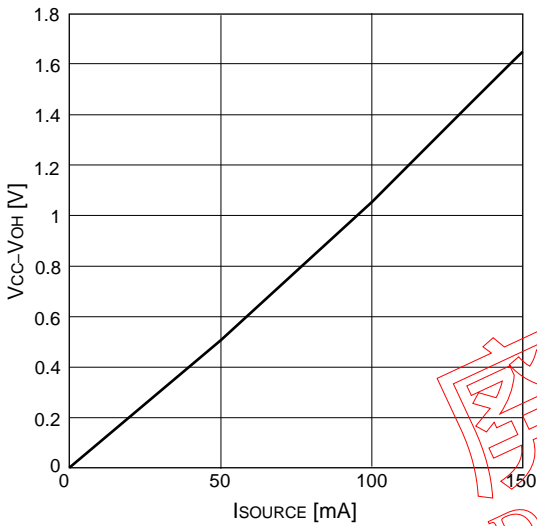

L-level output voltage (V_{OL}) vs. output sink current (I_{SINK}) for OUT2, 3, 4, 5, 6

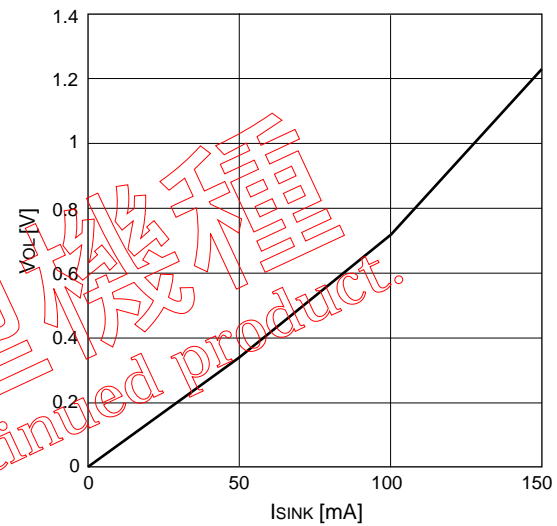

廢型機種
 Discontinued product.

Error amplifier voltage gain (A_v) / phase (θ) vs. frequency (f)

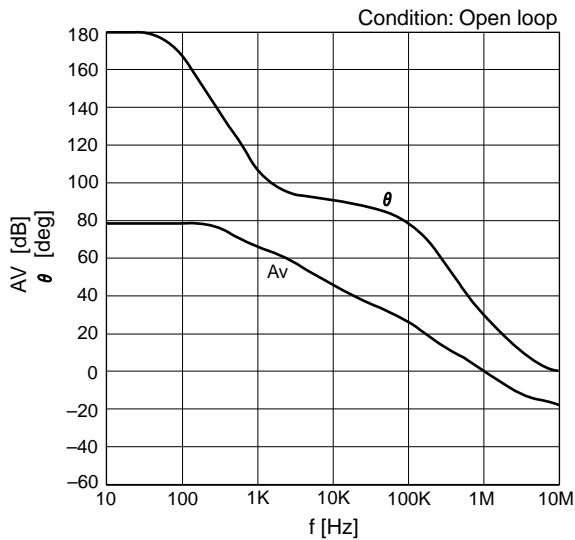

■ Application circuit

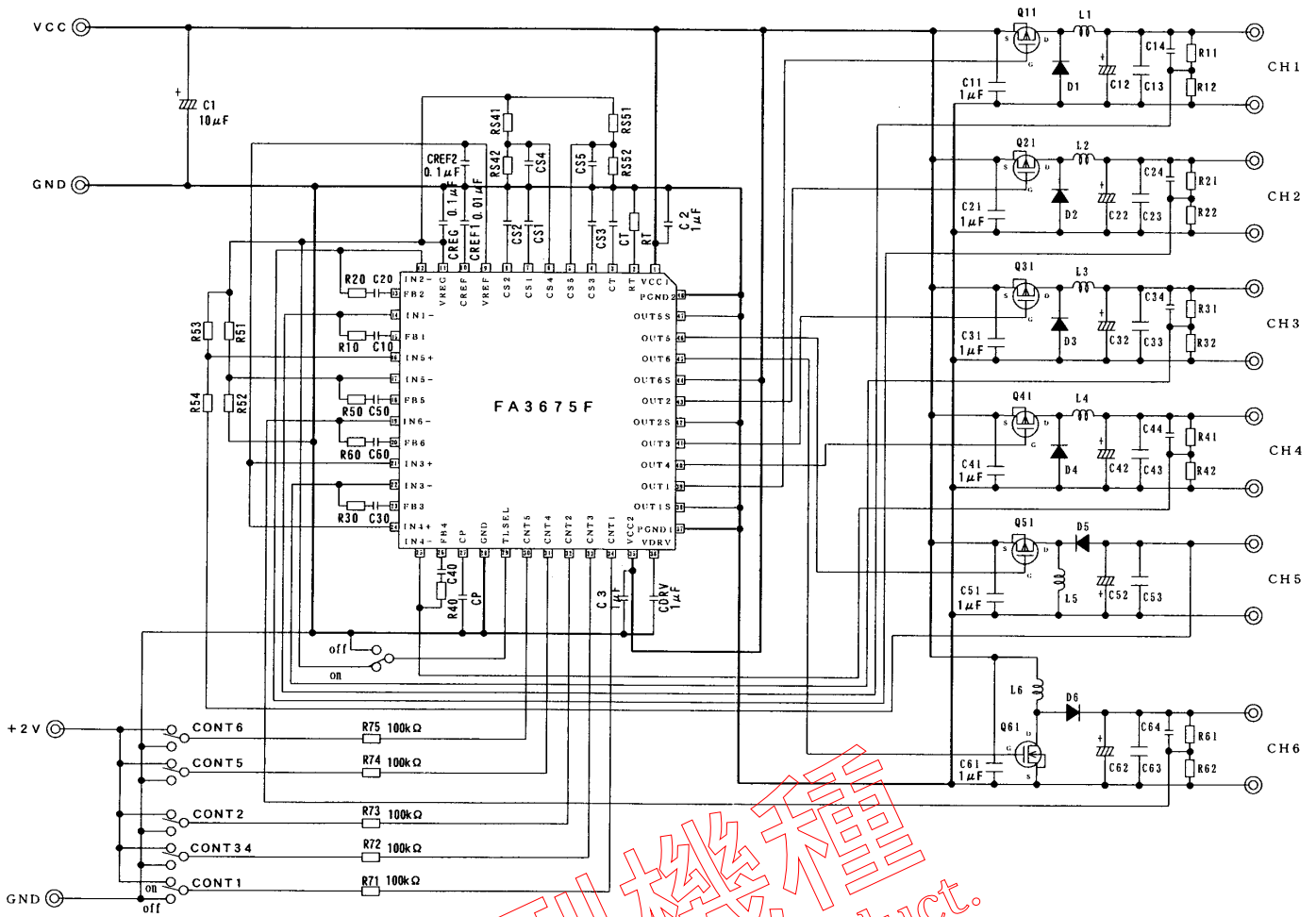

Parts tolerances characteristics are not defined in the circuit design sample shown above. When designing an actual circuit for a product, you must determine parts tolerances and characteristics for safe and economical operation.

WARNING

1. This Data Book contains the product specifications, characteristics, data, materials, and structures as of September 1999. The contents are subject to change without notice for specification changes or other reasons. When using a product listed in this Data Book, be sure to obtain the latest specifications.
2. All applications described in this Data Book exemplify the use of Fuji's products for your reference only. No right or license, either express or implied, under any patent, copyright, trade secret or other intellectual property right owned by Fuji Electric Co., Ltd. is (or shall be deemed) granted. Fuji makes no representation or warranty, whether express or implied, relating to the infringement or alleged infringement of other's intellectual property rights which may arise from the use of the applications described herein.
3. Although Fuji Electric is enhancing product quality and reliability, a small percentage of semiconductor products may become faulty. When using Fuji Electric semiconductor products in your equipment, you are requested to take adequate safety measures to prevent the equipment from causing a physical injury, fire, or other problem if any of the products become faulty. It is recommended to make your design fail-safe, flame retardant, and free of malfunction.
4. The products introduced in this Data Book are intended for use in the following electronic and electrical equipment which has normal reliability requirements.
 - Computers
 - OA equipment
 - Communications equipment (terminal devices)
 - Measurement equipment
 - Machine tools
 - Audiovisual equipment
 - Electrical home appliances
 - Personal equipment
 - Industrial robots etc.
5. If you need to use a product in this Data Book for equipment requiring higher reliability than normal, such as for the equipment listed below, it is imperative to contact Fuji Electric to obtain prior approval. When using these products for such equipment, take adequate measures such as a backup system to prevent the equipment from malfunctioning even if a Fuji's product incorporated in the equipment becomes faulty.
 - Transportation equipment (mounted on cars and ships)
 - Trunk communications equipment
 - Traffic-signal control equipment
 - Gas leakage detectors with an auto-shut-off feature
 - Emergency equipment for responding to disasters and anti-burglary devices
 - Safety devices
6. Do not use products in this Data Book for the equipment requiring strict reliability such as (without limitation)
 - Space equipment
 - Aeronautic equipment
 - Atomic control equipment
 - Submarine repeater equipment
 - Medical equipment
7. Copyright ©1995 by Fuji Electric Co., Ltd. All rights reserved.
No part of this Data Book may be reproduced in any form or by any means without the express permission of Fuji Electric.
8. If you have any question about any portion in this Data Book, ask Fuji Electric or its sales agents before using the product. Neither Fuji nor its agents shall be liable for any injury caused by any use of the products not in accordance with instructions set forth herein.