

SPECIFICATION

Device Name : Power MOSFET
 FMI16N50E (T-pack L)
 FMC16N50E (T-pack S)
Type Name : FMB16N50E (T-pack SJ)
Spec. No. : **MS5F6867**
Date : *July.-19-2007*

This material and the information herein is the property of Fuji Electric Device Technology Co.,Ltd. They shall be neither reproduced, copied, lent, or disclosed in any way whatsoever for the use of any third party nor used for the manufacturing purposes without the express written consent of Fuji Electric Device Technology Co., Ltd.

Fuji Electric Device Technology Co.,Ltd.

	DATE	NAME	APPROVED	Fuji Electric Device Technology Co., Ltd.		
DRAWN	<i>July.-19-'07</i>	<i>Y. Yasuda</i>		DWG. NO.	MS5F6867	
CHECKED	<i>July.-19-'07</i>	<i>Y. Ota</i>	<i>T. HOSEN</i>			1/18
CHECKED	<i>July.-19-'07</i>	<i>O. Kameda</i>				

Revised Records

Date	Classification	Index	Content	Drawn	Checked	Checked	Approved
July.-19 2007	enactment	—	—————	Y. Yasuda	Y. Ota	O. Tamada	T. HOSEN

This material and the information herein is the property of Fuji Electric Device Technology Co., Ltd. They shall be neither reproduced, copied, lent, or disclosed in any way whatsoever for the use of any third party nor used for the manufacturing purposes without the express written consent of Fuji Electric Device Technology Co., Ltd.

This material and the information herein is the property of Fuji Electric Device Technology Co., Ltd. They shall be neither reproduced, copied, lent, or disclosed in any way whatsoever for the use of any third party nor used for the manufacturing purposes without the express written consent of Fuji Electric Device Technology Co., Ltd.

- 1.Scope** This specifies Fuji Power MOSFET FMI16N50E, FMC16N50E, FMB16N50E
- 2.Construction** N-Channel enhancement mode power MOSFET
- 3.Applications** for Switching
- 4.Outview** T-Pack L Outview See to 11/18 page
T-Pack S Outview See to 12/18 page
T-Pack SJ Outview See to 13/18 page

5.Absolute Maximum Ratings at Tc=25°C (unless otherwise specified)

Description	Symbol	Characteristics	Unit	Remarks
Drain-Source Voltage	V _{DS}	500	V	
	V _{DSX}	500	V	V _{GS} =-30V
Continuous Drain Current	I _D	± 16	A	
Pulsed Drain Current	I _{DP}	± 64	A	
Gate-Source Voltage	V _{GS}	± 30	V	
Repetitive and Non-Repetitive Maximum Avalanche Current	I _{AR}	16	A	Note *1
Non-Repetitive Maximum Avalanche Energy	E _{AS}	485	mJ	Note *2
Repetitive Maximum Avalanche Energy	E _{AR}	22.5	mJ	Note *3
Peak Diode Recovery dV/dt	dV/dt	7.8	kV/μs	Note *4
Peak Diode Recovery -di/dt	-di/dt	100	A/μs	Note *5
Maximum Power Dissipation	P _D	1.67	W	T _a =25
		225		T _c =25
Operating and Storage Temperature range	T _{ch}	150		
	T _{stg}	-55 to +150		

6.Electrical Characteristics at Tc=25°C (unless otherwise specified)

Static Ratings

Description	Symbol	Conditions	min.	typ.	max.	Unit
Drain-Source Breakdown Voltage	BV _{DSS}	I _D =250 μA V _{GS} =0V	500	-	-	V
Gate Threshold Voltage	V _{GS(th)}	I _D =250 μA V _{DS} =V _{GS}	2.5	3.0	3.5	V
Zero Gate Voltage Drain Current	I _{DSS}	V _{DS} =500V V _{GS} =0V T _{ch} =25	-	-	25	μA
		V _{DS} =400V V _{GS} =0V T _{ch} =125	-	-	250	
Gate-Source Leakage Current	I _{GSS}	V _{GS} = ±30V V _{DS} =0V	-	10	100	nA
Drain-Source On-State Resistance	R _{DS(on)}	I _D =8A V _{GS} =10V	-	0.33	0.38	

Dynamic Ratings

Description	Symbol	Conditions	min.	typ.	max.	Unit
Forward Transconductance	g_{fs}	$I_D=8A$ $V_{DS}=25V$	8.5	17	-	S
Input Capacitance	C_{iss}	$V_{DS}=25V$	-	2150	3225	pF
Output Capacitance	C_{oss}	$V_{GS}=0V$	-	210	315	
Reverse Transfer Capacitance	C_{rss}	$f=1MHz$	-	16	24	
Turn-On Time	$t_{d(on)}$	$V_{cc}=300V, V_{GS}=10V$	-	21	31.5	ns
	t_r	$I_D=8A, R_{GS}=10\Omega$	-	9	13.5	
Turn-Off Time	$t_{d(off)}$	See Fig.3 and Fig.4	-	100	150	
	t_f		-	16	24	
Total Gate Charge	Q_G	$V_{cc}=250V, I_D=16A$	-	60	90	nC
Gate-Source Charge	Q_{GS}	$V_{GS}=10V$	-	17	25.5	
Gate-Drain Charge	Q_{GD}	See Fig.5	-	18	27	

Reverse Diode

Description	Symbol	Conditions	min.	typ.	max.	Unit
Avalanche Capability	I_{AV}	$L=1.52mH, T_{ch}=25$ See Fig.1 and Fig.2	16	-	-	A
Diode Forward On-Voltage	V_{SD}	$I_F=16A$ $V_{GS}=0V, T_{ch}=25$	-	0.90	1.35	V
Reverse Recovery Time	t_{rr}	$I_F=16A, V_{GS}=0V$ $-di/dt=100A/\mu s, T_{ch}=25$	-	0.46	-	μs
Reverse Recovery Charge	Q_{rr}	See Fig.6	-	6.0	-	μC

7.Thermal Resistance

Description	Symbol	min.	typ.	max.	Unit
Channel to Case	$R_{th(ch-c)}$			0.560	/W
Channel to Ambient	$R_{th(ch-a)}$			75.0	/W

Note *1 : $T_{ch} \leq 150$, See Fig.1 and Fig.2

Note *2 : Stating $T_{ch}=25$, $I_{AS}=7A, L=18.1mH, V_{cc}=50V, R_G=50$, See Fig.1 and Fig.2
 E_{AS} limited by maximum channel temperature and avalanche current.
 See to 'Avalanche Energy' graph of page 9/18.

Note *3 : Repetitive rating : Pulse width limited by maximum channel temperature.
 See to the 'Transient Thermal impedance' graph of page 9/18.

Note *4 : $I_F \leq -I_D, -di/dt=100A/\mu s, V_{cc} \leq BV_{DSS}, T_{ch} \leq 150$.

Note *5 : $I_F \leq -I_D, dv/dt=7.8kV/\mu s, V_{cc} \leq BV_{DSS}, T_{ch} \leq 150$.

8. Reliability test items

All guaranteed values are under the categories of reliability per non-assembled(only MOSFETs). Each categories under the guaranteed reliability conform to EIAJ ED4701/100 method104 standards.

Test items required without fail.

Humidification treatment (85±2°C,65±5%RH,168±24hr)

Heat treatment of soldering

Through Hole Package (Solder Dipping,260±5°C(265°Cmax.),10±1sec,2 times)

SMD Package(IR-ray Reflow ,255±5°C(260°Cmax.),10±1sec,2 times)

Test No.	Test Items	Testing methods and Conditions	Reference Standard	Sampling number	Acceptance number
Mechanical test methods	1 Terminal Strength (Tensile) (Through Hole)	Pull force TO-220,TO-220F : 10N TO-3P,TO-3PF,TO-247 : 25N TO-3PL : 45N T-Pack,K-Pack : 10N Force maintaining duration :30±5sec	EIAJ ED4701/400 method 401	15	(0:1)
	2 Terminal Strength (Bending) (Through Hole)	Load force TO-220,TO-220F : 5N TO-3P,TO-3PF,TO-247 : 10N TO-3PL : 15N T-Pack,K-Pack : 5N Number of times :2times(90deg./time)	EIAJ ED4701/400 method 401	15	
	3 Mounting Strength (Through Hole)	Screwing torque value: (M3) TO-220,TO-220F : 40±10N·cm TO-3P,TO-3PF,TO-247 : 50±10N·cm TO-3PL : 70±10N·cm	EIAJ ED4701/400 method 402	15	
	4 Vibration	frequency : 100Hz to 2kHz Acceleration : 200m/s ² Sweeping time : 4min. 48min. for each X,Y&Z directions.	EIAJ ED4701/400 method 403	15	
	5 Shock	Peak amplitude: 15km/s ² Duration time : 0.5ms 3times for each X,Y&Z directions.	EIAJ ED4701/400 method 404	15	
	6 Solderability	Solder temp. : 245±5°C Immersion time : 5±0.5sec About Through Hole Package type, each terminal shall be immersed in the solder bath within 1 to 1.5mm from the body.	----	15	
	7 Resistance to Soldering Heat (Through Hole)	Solder temp. : 260±5°C Immersion time : 10±1sec Number of times : 1times	EIAJ ED4701/300 method 302	15	
Resistance to Soldering Heat (SMD Type)	Solder temp. : 255±5°C Immersion time : 10±1sec Number of times : 2times IR-ray Reflowing	EIAJ ED4701/400 method 301	15		

This material and the information herein is the property of Fuji Electric Device Technology Co.,Ltd. They shall be neither reproduced, copied, lent, or disclosed in any way whatsoever for the use of any third party nor used for the manufacturing purposes without the express written consent of Fuji Electric Device Technology Co., Ltd.

This material and the information herein is the property of Fuji Electric Device Technology Co., Ltd. They shall be neither reproduced, copied, lent, or disclosed in any way whatsoever for the use of any third party nor used for the manufacturing purposes without the express written consent of Fuji Electric Device Technology Co., Ltd.

	Test No.	Test Items	Testing methods and Conditions	Reference Standard	Sampling number	Acceptance number
Climatic test methods	1	High Temp. Storage	Temperature : 150+0/-5°C Test duration : 1000hr	EIAJ ED4701/200 method 201	22	(0:1)
	2	Low Temp. Storage	Temperature : -55+5/-0°C Test duration : 1000hr	EIAJ ED4701/200 method 202	22	
	3	Temperature Humidity Storage	Temperature : 85±2°C Relative humidity : 85±5% Test duration : 1000hr	EIAJ ED4701/100 method 103	22	
	4	Temperature Humidity BIAS	Temperature : 85±2°C Relative humidity : 85±5% Bias Voltage : V _{DS} (max) × 0.8 Test duration : 1000hr	EIAJ ED4701/100 method 103	22	
	5	Unsaturated Pressurized Vapor	Temperature : 130±2°C Relative humidity : 85±5% Vapor pressure : 230kPa Test duration : 48hr	EIAJ ED4701/100 method 103	22	
	6	Temperature Cycle	High temp.side : 150±5°C/30min. Low temp.side : -55±5°C/30min. RT : 5°C ~ 35°C/5min. Number of cycles : 100cycles	EIAJ ED4701/100 method 105	22	
	7	Thermal Shock	Fluid : pure water(running water) High temp.side : 100+0/-5°C Low temp.side : 0+5/-0°C Duration time : HT 5min,LT 5min Number of cycles : 100cycles	EIAJ ED4701/300 method 307	22	
Endurance test methods	8	Intermittent Operating Life	T _c =90degree T _{ch} ≤T _{ch} (max.) Test duration : 3000 cycle	EIAJ ED4701/100 method 106	22	(0:1)
	9	HTRB (Gate-source)	Temperature : T _{ch} =150+0/-5°C Bias Voltage : +V _{GS} (max) Test duration : 1000hr	EIAJ ED4701/100 method 101	22	
	10	HTRB (Drain-Source)	Temperature : T _{ch} =150+0/-5°C Bias Voltage : V _{DS} (max) Test duration : 1000hr	EIAJ ED4701/100 method 101	22	

Failure Criteria

	Item	Symbols	Failure Criteria		Unit
			Lower Limit	Upper Limit	
Electrical Characteristics	Breakdown Voltage	BVDSS	LSL	-----	V
	Zero gate Voltage Drain-Source Current	IDSS	-----	USL	A
	Gate-Source Leakage Current	IGSS	-----	USL	A
	Gate Threshold Voltage	VGS(th)	LSL	USL	V
	Drain-Source on-state Resistance	RDS(on)	-----	USL	
	Forward Transconductance	gfs	LSL	-----	S
	Diode forward on-Voltage	VSD	-----	USL	V
Outvie w	Marking Soldering and other damages	-----	With eyes or Microscope		-----

* LSL : Lower Specification Limit

* USL : Upper Specification Limit

* Before any of electrical characteristics measure, all testing related to the humidity have conducted after drying the package surface for more than an hour at 150 .

This material and the information herein is the property of Fuji Electric Device Technology Co., Ltd. They shall be neither reproduced, copied, lent, or disclosed in any way whatsoever for the use of any third party nor used for the manufacturing purposes without the express written consent of Fuji Electric Device Technology Co., Ltd.

Allowable Power Dissipation
 $P_D = f(T_c)$

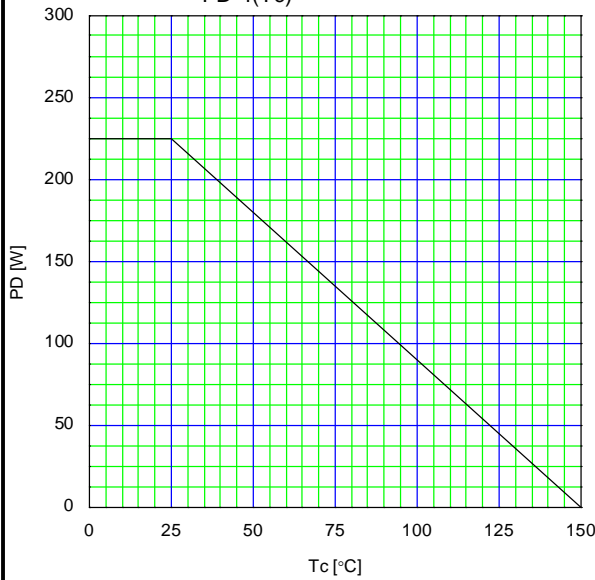

Safe Operating Area
 $I_D = f(V_{DS})$: Duty=0 (Single pulse), $T_c = 25^\circ\text{C}$

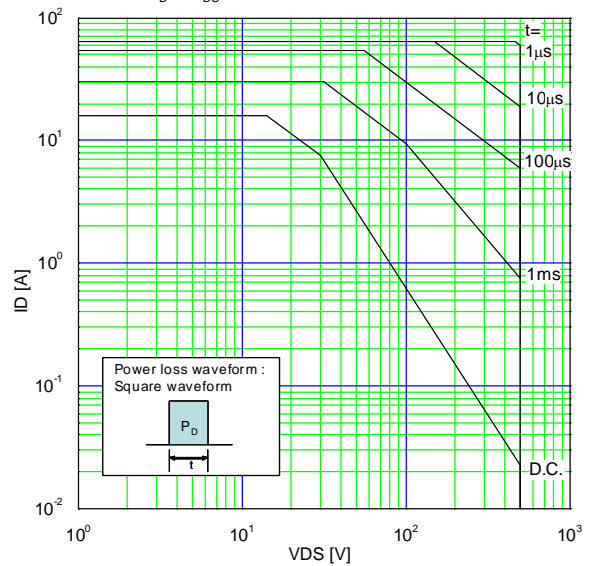

Typical Output Characteristics
 $I_D = f(V_{DS})$: 80 µs pulse test, $T_{ch} = 25^\circ\text{C}$

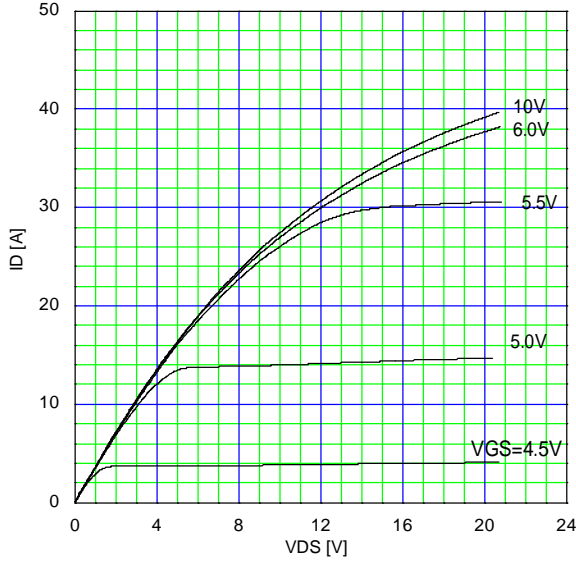

Typical Transfer Characteristic
 $I_D = f(V_{GS})$: 80 µs pulse test, $V_{DS} = 25\text{V}$, $T_{ch} = 25^\circ\text{C}$

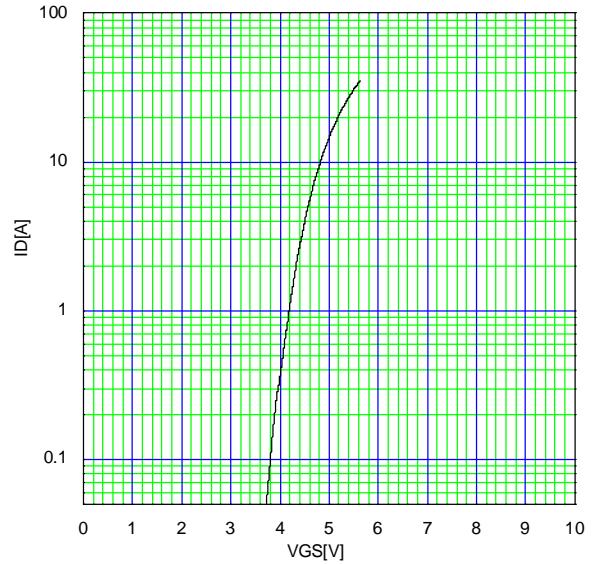

Typical Transconductance
 $g_{fs} = f(I_D)$: 80 µs pulse test, $V_{DS} = 25\text{V}$, $T_{ch} = 25^\circ\text{C}$

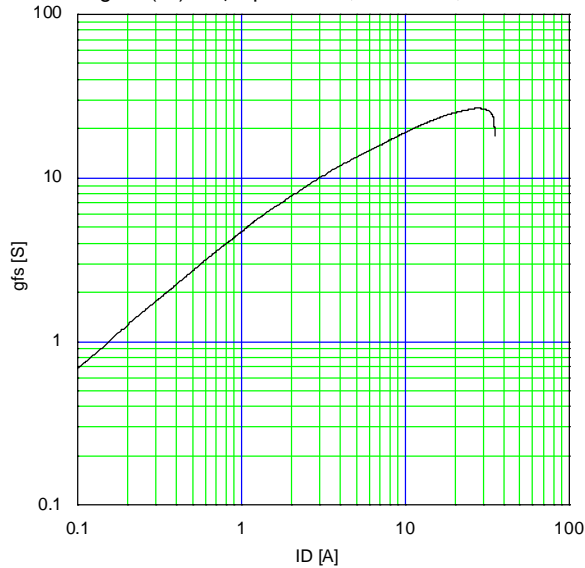

Typical Drain-Source on-state Resistance
 $R_{DS(on)} = f(I_D)$: 80 µs pulse test, $T_{ch} = 25^\circ\text{C}$

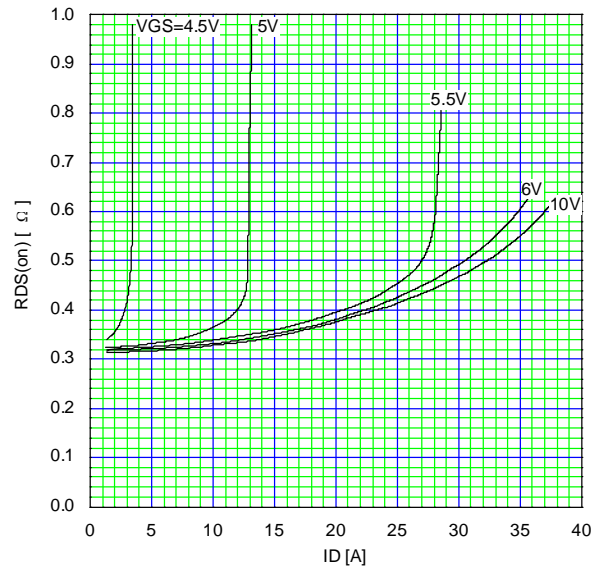

This material and the information herein is the property of Fuji Electric Device Technology Co., Ltd. They shall be neither reproduced, copied, lent, or disclosed in any way whatsoever for the use of any third party nor used for the manufacturing purposes without the express written consent of Fuji Electric Device Technology Co., Ltd.

Drain-Source On-state Resistance
 $R_{DS(on)}=f(T_{ch}):I_D=8A, V_{GS}=10V$

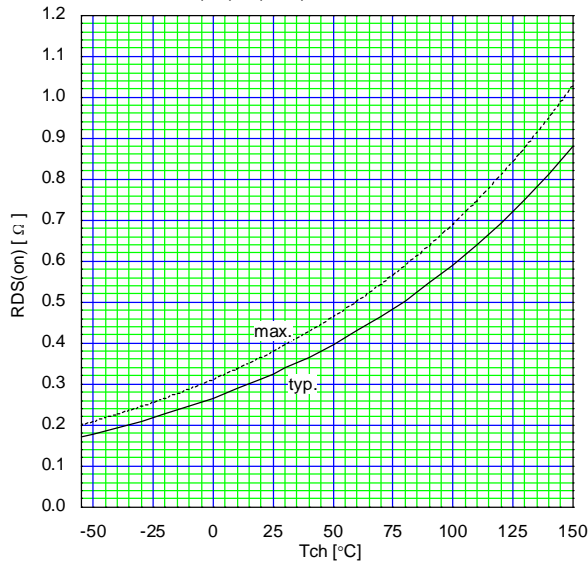

Gate Threshold Voltage vs. T_{ch}
 $V_{GS(th)}=f(T_{ch}):V_{DS}=V_{GS}, I_D=250\mu A$

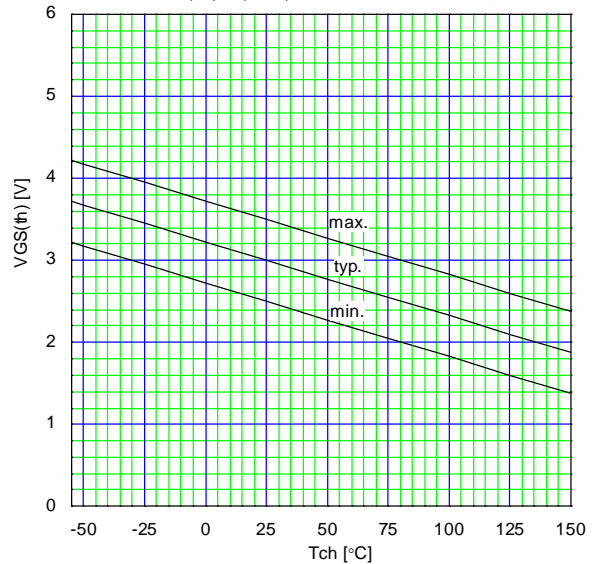

Typical Gate Charge Characteristics
 $V_{GS}=f(Q_g):I_D=16A, T_{ch}=25^\circ C$

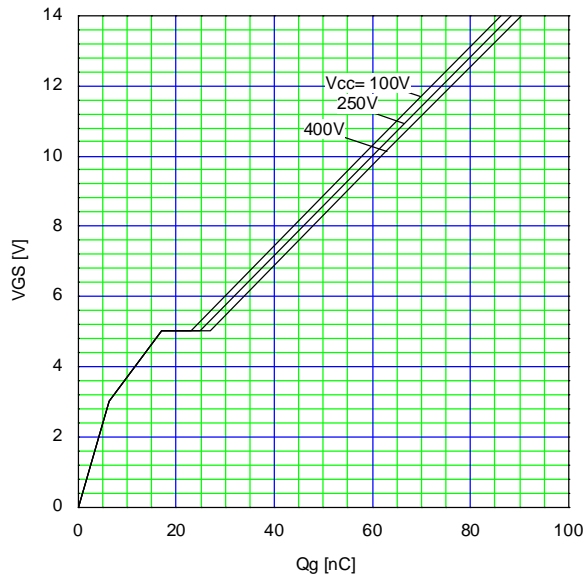

Typical Capacitance
 $C=f(V_{DS}):V_{GS}=0V, f=1MHz$

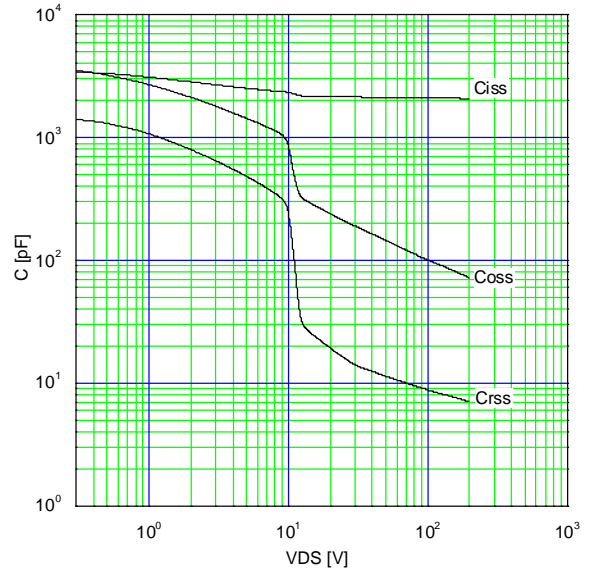

Typical Forward Characteristics of Reverse Diode
 $I_F=f(V_{SD}):80\mu s \text{ pulse test}, T_{ch}=25^\circ C$

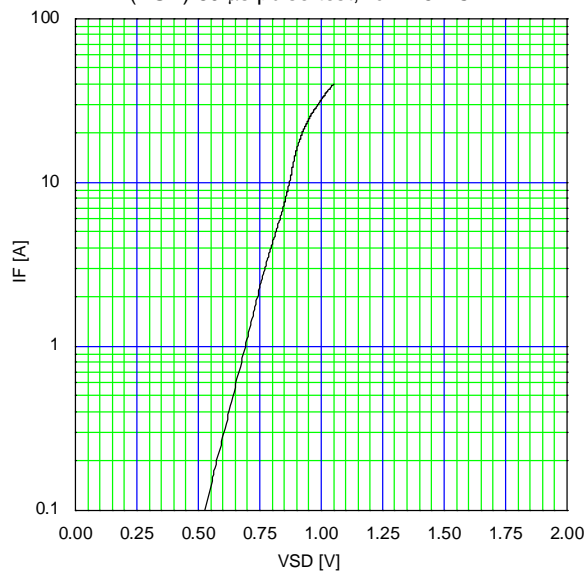

Typical Switching Characteristics vs. I_D
 $t=f(I_D):V_{cc}=300V, V_{GS}=10V, R_G=10\Omega$

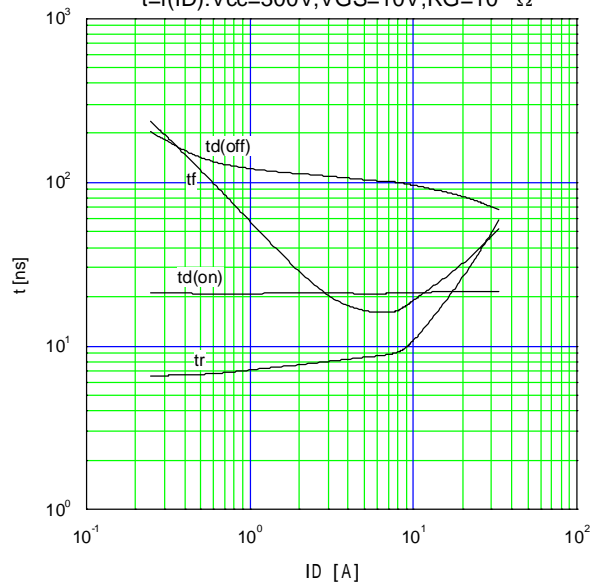

This material and the information herein is the property of Fuji Electric Device Technology Co., Ltd. They shall be neither reproduced, copied, lent, or disclosed in any way whatsoever for the use of any third party nor used for the manufacturing purposes without the express written consent of Fuji Electric Device Technology Co., Ltd.

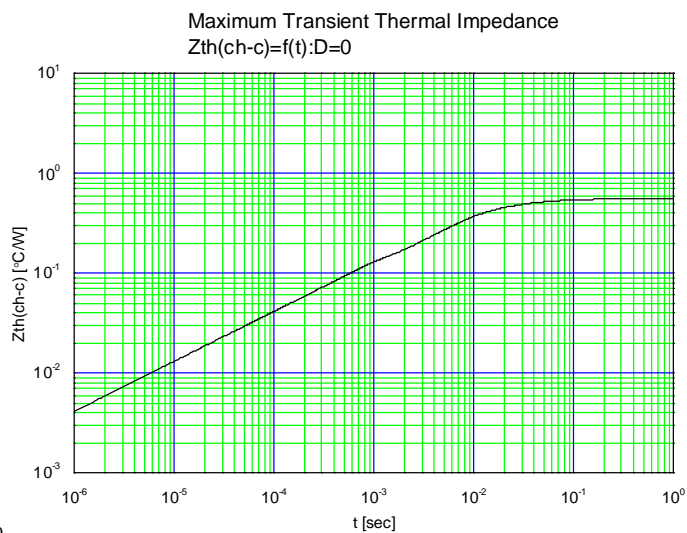
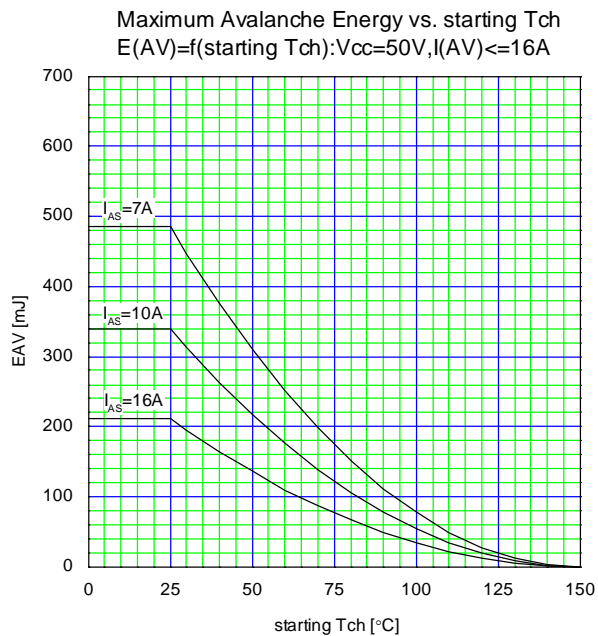

Fig.1 Avalanche Test circuit

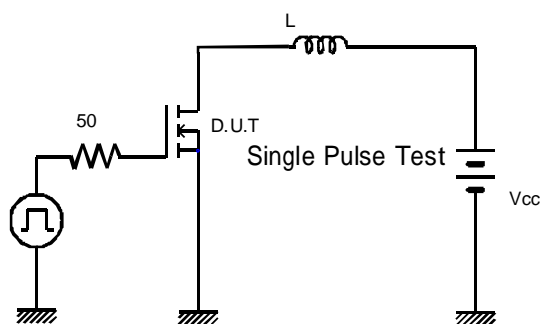

Fig.2 Operating waveforms of Avalanche Test

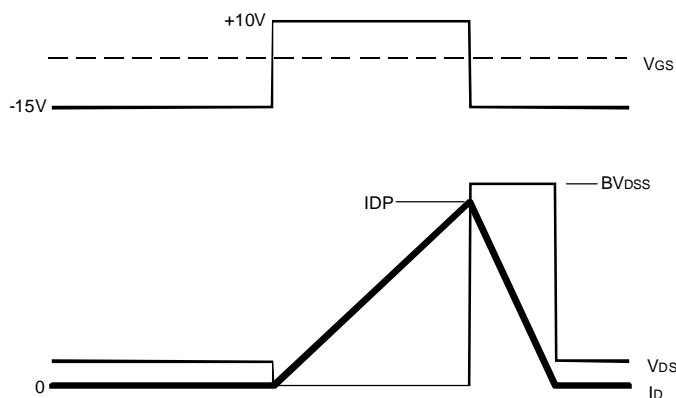

Fig.3 Switching Test circuit

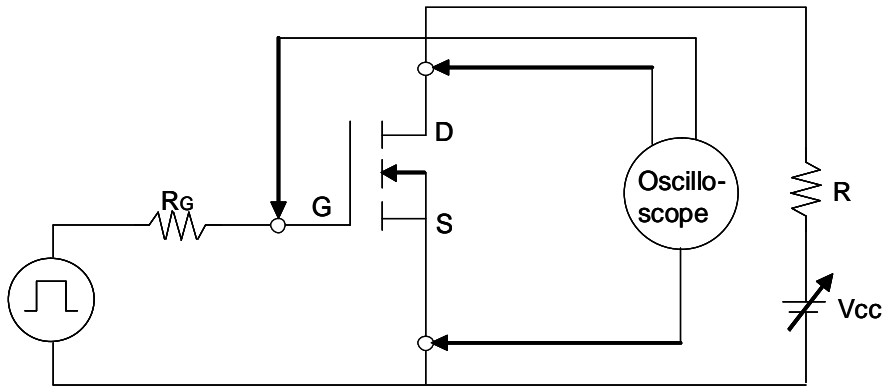

Fig.4 Operating waveform of Switching Test

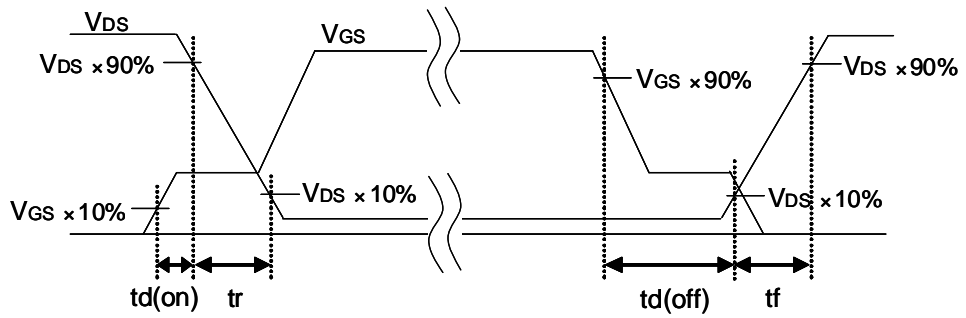

Fig.5 Operating waveform of Gate charge Test

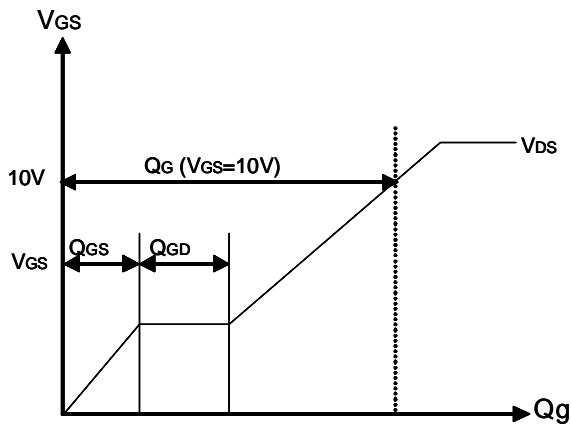
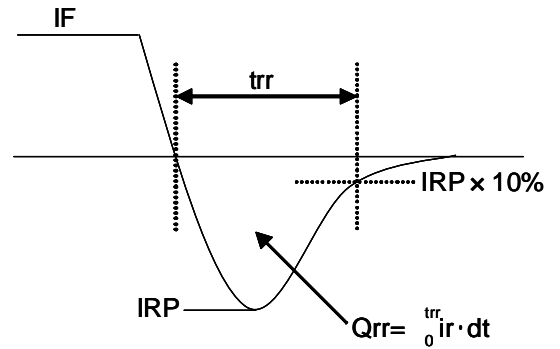
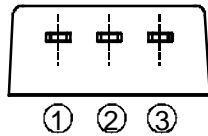
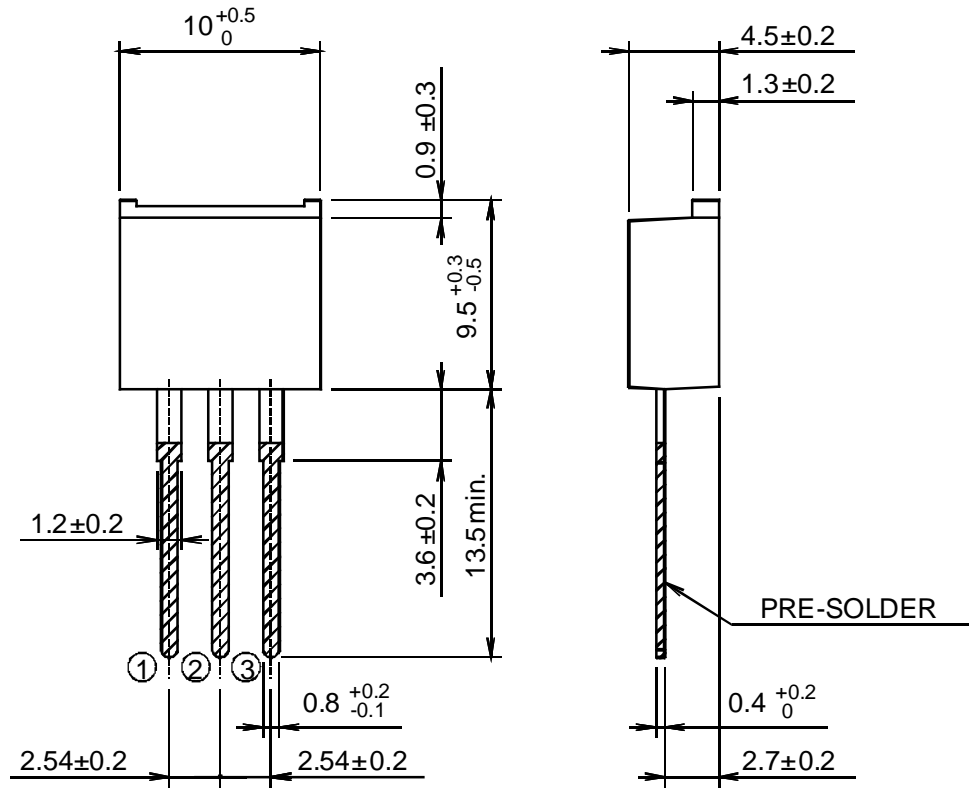

Fig.6 Operating waveform of Body diode Recovery Test



This material and the information herein is the property of Fuji Electric Device Technology Co., Ltd. They shall be neither reproduced, copied, lent, or disclosed in any way whatsoever for the use of any third party nor used for the manufacturing purposes without the express written consent of Fuji Electric Device Technology Co., Ltd.

Outview: T-pack(L) Package



CONNECTION

- ① GATE
- ② DRAIN
- ③ SOURCE

DIMENSIONS ARE IN MILLIMETERS.

Marking

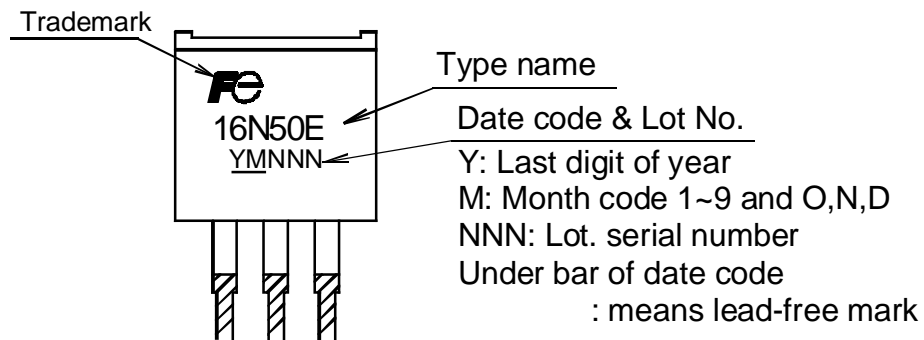

* The font (font type,size) and the trademark-size might be actually different.

This material and the information herein is the property of Fuji Electric Device Technology Co., Ltd. They shall be neither reproduced, copied, lent, or disclosed in any way whatsoever for the use of any third party nor used for the manufacturing purposes without the express written consent of Fuji Electric Device Technology Co., Ltd.

Outview: T-Pack(S) Package

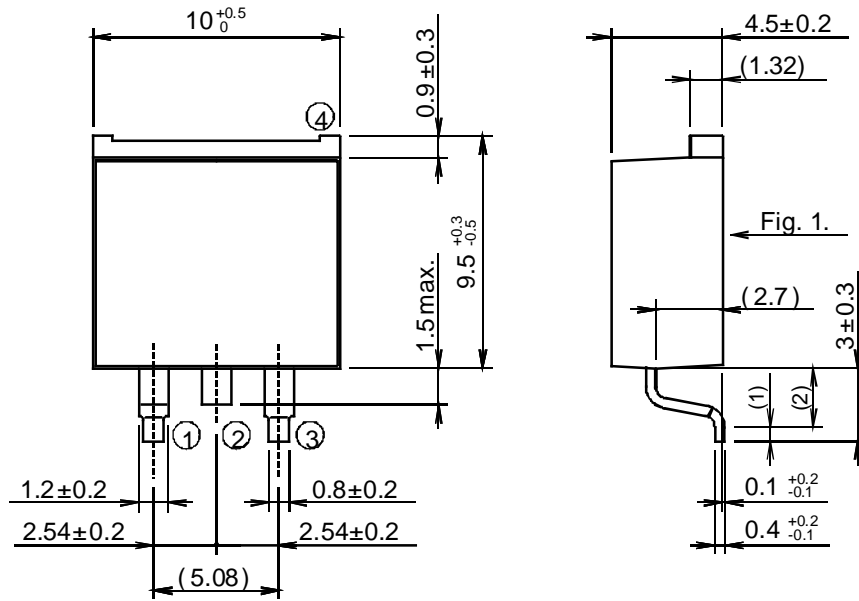
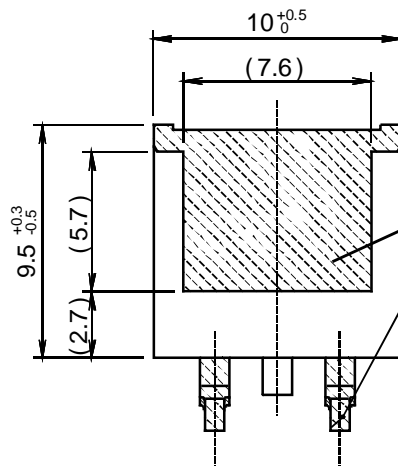

Fig. 1.

CONNECTION

- ① GATE
- ④ ② DRAIN
- ③ SOURCE



Solder Plating

Notes

1. () : Reference dimensions.
2. The metal part is covered with the solder plating, part of cutting is without the solder plating.

DIMENSIONS ARE IN MILLIMETERS.

Marking

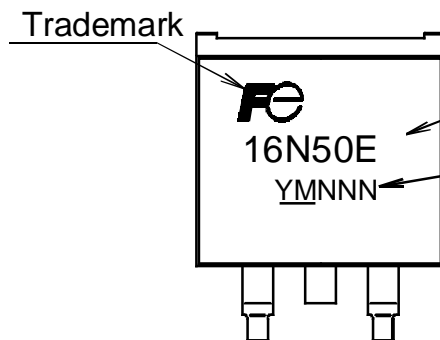

Type name

Date code & Lot No.

Y: Last digit of year

M: Month code 1~9 and O,N,D

NNN: Lot. serial number

Under bar of date code

: means lead-free mark

* The font (font type,size) and the trademark-size might be actually different.

This material and the information herein is the property of Fuji Electric Device Technology Co., Ltd. They shall be neither reproduced, copied, lent, or disclosed in any way whatsoever for the use of any third party nor used for the manufacturing purposes without the express written consent of Fuji Electric Device Technology Co., Ltd.

9. Cautions

- Although Fuji Electric is continually improving product quality and reliability, a small percentage of semiconductor products may become faulty. When using Fuji Electric semiconductor products in your equipment, you are requested to take adequate safety measures to prevent the equipment from causing physical injury, fire, or other problem in case any of the products fail. It is recommended to make your design fail-safe, flame retardant, and free of malfunction.
- The products described in this Specification are intended for use in the following electronic and electrical equipment which has normal reliability requirements.
 - Computers • OA equipment • Communications equipment(Terminal devices)
 - Machine tools • AV equipment • Measurement equipment
 - Personal equipment • Industrial robots • Electrical home appliances etc.
- The products described in this Specification are not designed or manufactured to be used in equipment or systems used under life-threatening situations. If you are considering using these products in the equipment listed below, first check the system construction and required reliability, and take adequate safety measures such as a backup system to prevent the equipment from malfunctioning.
 - Backbone network equipment • Transportation equipment (automobiles, trains, ships, etc.)
 - Traffic-signal control equipment • Gas alarms, leakage gas auto breakers
 - Submarine repeater equipment • Burglar alarms, fire alarms, emergency equipment
 - Medical equipment • Nuclear control equipment etc.
- Do not use the products in this Specification for equipment requiring strict reliability such as(but not limited to):
 - Aerospace equipment • Aeronautical equipment

10. Warnings

- The MOSFETs should be used in products within their absolute maximum rating(voltage, current, temperature, etc.).
- The MOSFETs may be destroyed if used beyond the rating.
- We only guarantee the non-repetitive and repetitive Avalanche capability and not for the continuous Avalanche capability which can be assumed as abnormal condition .Please note the device may be destructed from the Avalanche over the specified maximum rating.
- The equipment containing MOSFETs should have adequate fuses or circuit breakers to prevent the equipment from causing secondary destruction.
- Use the MOSFETs within their reliability and lifetime under certain environments or conditions. The MOSFETs may fail before the target lifetime of your products if used under certain reliability conditions.
- You must careful handling of MOSFETs for ESD damage is an important consideration.
- When handling MOSFETs, hold them by the case (package) and don't touch the leads and terminals.
- It is recommended that any handling of MOSFETs is done while used electrically conductive floor and tablemats that are grounded.

- Before touching a MOSFET terminal, Discharge any static electricity from your body and clothes by grounding out through a high impedance resistor (about 1MΩ)
- When soldering, in order to protect the MOSFETs from static electricity, ground the soldering iron or soldering bath through a low impedance resistor.
- You must design the MOSFETs to be operated within the specified maximum ratings(voltage, current, temperature, etc.) to prevent possible failure or destruction of devices.
- Consider the possible temperature rise not only for the channel and case, but also for the outer leads.
- Do not directly touch the leads or package of the MOSFETs while power is supplied or during operation in order to avoid electric shock and burns.
- The MOSFETs are made of incombustible material. However, if a MOSFET fails, it may emit smoke or flame. Also, operating the MOSFETs near any flammable place or material may cause the MOSFETs to emit smoke or flame in case the MOSFETs become even hotter during operation. Design the arrangement to prevent the spread of fire.
- The MOSFETs should not used in an environment in the presence of acid, organic matter, or corrosive gas(hydrogen sulfide, sulfurous acid gas etc.)
- The MOSFETs should not used in an irradiated environment since they are not radiation-proof.

Installation

- Soldering involves temperatures which exceed the device storage temperature rating. To avoid device damage and to ensure reliability, observe the following guidelines from the quality assurance standard.

Solder temperature and duration (through-hole package)

Solder temperature	Duration
260±5 °C	10±1 seconds
350±10 °C	3.5±0.5 seconds

- The immersion depth of the lead should basically be up to the lead stopper and the distance should be a maximum of 1.5mm from the device.
- When flow-soldering, be careful to avoid immersing the package in the solder bath.

Recommended soldering condition

Categories	Packages	Methods				
		Wave Soldering (Full dipping)	Wave Soldering (Only terminal)	Infrared Reflow	Air Reflow	Soldering iron (Re-work)
Through-Hole	TO-3PL	x		x	x	
	TO-3P	x		x	x	
	TO-247	x		x	x	
	TO-3PF	x		x	x	
	TO-220	x		x	x	
	TO-220F	x		x	x	
	T-Pack(L)	x		x	x	
	TO-3PL-7	x		x	x	

: Possible : Limited to 1 time x : Unable

- Refer to the following torque reference when mounting the device on a heat sink. Excess torque applied to the mounting screw causes damage to the device and weak torque will increase the thermal resistance, both of which conditions may destroy the device.

Table 1: Recommended tightening torques.

Package style	Screw	Tightening torques	Note
TO-220 TO-220F	M3	30 – 50 Ncm	flatness : $< = \pm 30\mu\text{m}$ roughness : $< = 10\mu\text{m}$ Plane off the edges : C $< = 1.0\text{mm}$
TO-3P TO-3PF TO-247	M3	40 – 60 Ncm	
TO-3PL	M3	60 – 80 Ncm	

- The heat sink should have a flatness within $\pm 30\mu\text{m}$ and roughness within $10\mu\text{m}$. Also, keep the tightening torque within the limits of this specification.
- Improper handling may cause isolation breakdown leading to a critical accident.
ex.) Over plane off the edges of screw hole. (Recommended plane off the edge is C $< 1.0\text{mm}$)
- We recommend the use of thermal compound to optimize the efficiency of heat radiation. It is important to evenly apply the compound and to eliminate any air voids.

Installation/ SMD Package

- Soldering involves temperatures which exceed the device storage temperature rating. To avoid device damage and to ensure reliability, observe the following guidelines from the quality assurance standard.

Soldering temperature and duration (SMD Package)

	Reflow-Soldering
Number of times	Twice
Soldering Temp. & Time	≥ 230 , $\leq 50\text{sec}$
Package surface Peak Temp. & Time	≤ 260 , $\leq 10\text{sec}$

Soldering methods (SMD Package)

Packages	Methods				
	Wave Soldering (Full dipping)	Wave Soldering (Only terminal)	Infrared Reflow	Air Reflow	Soldering iron (Re-work)
T-Pack(S)	x	x			x
T-Pack(SJ)	x	x			x
K-Pack(S)	x	x			x
TFP	x	x			x

: Possible : Limited to 1 time x : Unable

Recommended Reflow profile

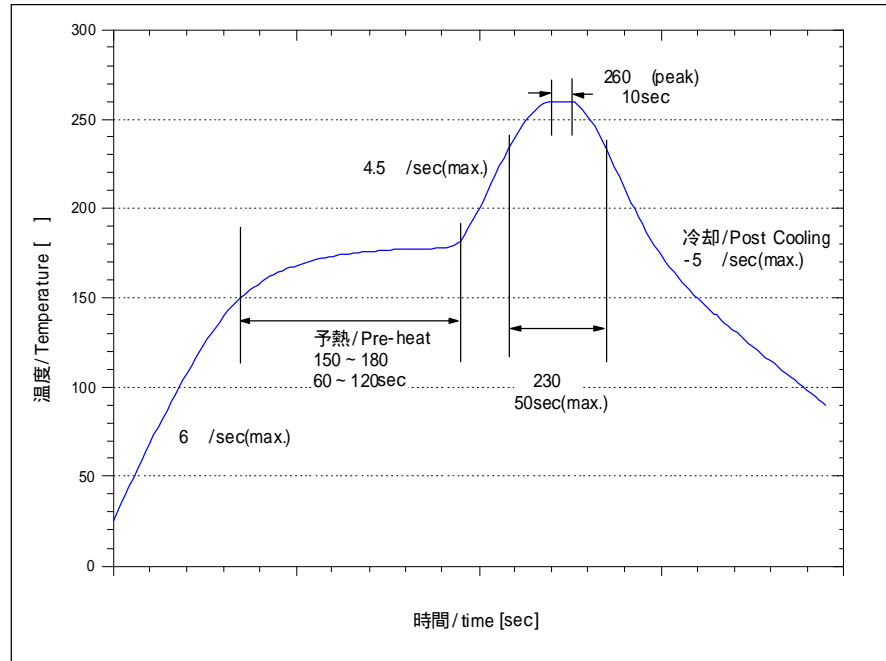

Storage

- The MOSFETs must be stored at a standard temperature of 5 to 35°C and relative humidity of 45 to 75%.
- If the storage area is very dry, a humidifier may be required. In such a case, use only deionized water or boiled water, since the chlorine in tap water may corrode the leads.
- The MOSFETs should not be subjected to rapid changes in temperature to avoid condensation on the surface of the MOSFETs. Therefore store the MOSFETs in a place where the temperature is steady.
- The MOSFETs should not be stored on top of each other, since this may cause excessive external force on the case.
- The MOSFETs should be stored with the lead terminals remaining unprocessed. Rust may cause presoldered connections to fail during later processing.
- The MOSFETs should be stored in antistatic containers or shipping bags.

11. Compliance with pertaining to restricted substances

11-1) Compliance with the RoHS Regulations and Exemptions

This product will be fully compliant with the RoHS directive (Directive 2002/95/EC of the European Parliament and the Council of 27 January 2003).

Five out of six substances below which are regulated by the RoHS directive in Europe are not included in this product. The exception is only lead.

The RoHS directive has some exemptions. The following relates to this product :

Lead in high melting temperature type solders (Sn-Pb solder alloy which contains more than 85%)

This product is used to the high melting temperature type solders (Sn-Pb solders) for die-bonding. Moreover, the terminals used lead-free solder.

* The six substances regulated by the RoHS Directive are:

Lead, Mercury, Hexavalent chromium, Cadmium, PBB (polybrominated biphenyls),
PBDE (polybrominated diphenyl ethers).

The maximum concentration value of the six substances in this product conforms to the Commission decision 2005/618/EC of EU of 18 August 2005.

11-2) Compliance with the class-1 ODS and class-2 ODS. (ODS: Ozone-Depleting Substances)

This product does not contain and used the "Law concerning the Protection of the Ozone Layer through the Control of Specified Substances and Other Measures (JAPAN)", and the Montreal Protocol.

- If you have any questions about any part of this Specification, please contact Fuji Electric Device Technology or its sales agent before using the product.
- Neither Fuji nor its agents shall be held liable for any injury caused by using the products not in accordance with the instructions.
- The application examples described in this specification are merely typical uses of Fuji Electric Device Technology products.
- This specification does not confer any industrial property rights or other rights, nor constitute a license for such rights.