

MS865C12 (120V, 20A)

FUJI Diode

Low IR Schottky Barrier Diode

■ Features

- Low IR
- Low V_F
- Center tap connection

■ Applications

- High frequency operation
- DC-DC converters
- AC adapter

■ Outline Drawings [mm]

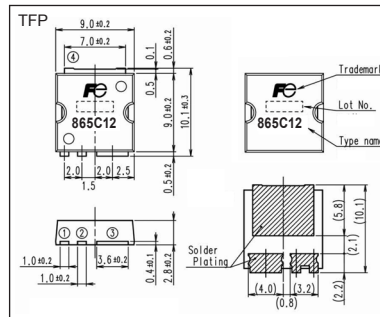

■ Connection diagram

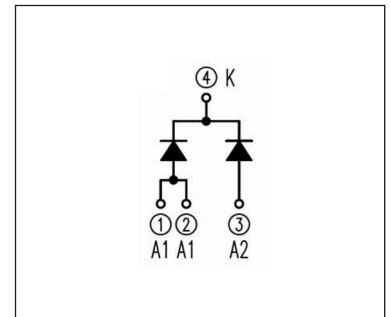

■ Maximum Ratings and Characteristics

● Maximum ratings (at $T_a=25^\circ\text{C}$ Unless otherwise specified)

Item	Symbols	Conditions	Ratings	Units
Repetitive peak reverse voltage	V_{RRM}		120	V
Average output current	I_o	Square wave duty =1/2 $T_c =126^\circ\text{C}$	20 *	A
Non-repetitive surge current **	I_{FSM}	Sine wave, 10ms 1shot	150	A
Operating junction temperature	T_j		150	$^\circ\text{C}$
Storage temperature	T_{stg}		-40 to +150	$^\circ\text{C}$

*Out put current of center tap full wave connection.

**Rating per element

● Electrical characteristics (at $T_a=25^\circ\text{C}$ Unless otherwise specified)

Item	Symbols	Conditions	Maximum	Units
Forward voltage***	V_F	$I_F = 10 \text{ A}$	0.88	V
Reverse current***	I_R	$V_R = V_{RRM}$	150	μA
Thermal resistance	$R_{th(j-c)}$	Junction to case	1.25	$^\circ\text{C/W}$

***Rating per element

● Mechanical characteristics

Item	Conditions	Ratings	Units
Approximate mass		0.8	g

Forward Characteristic (typ.)

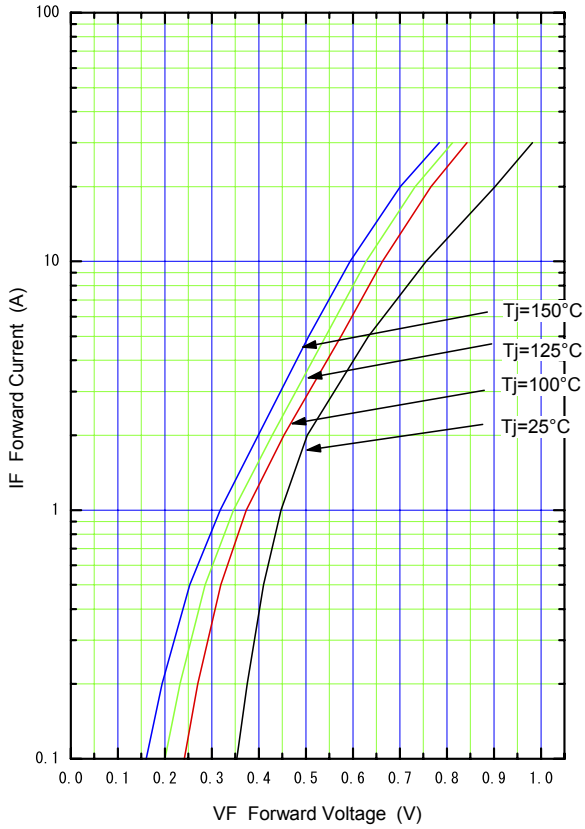

Reverse Characteristic (typ.)

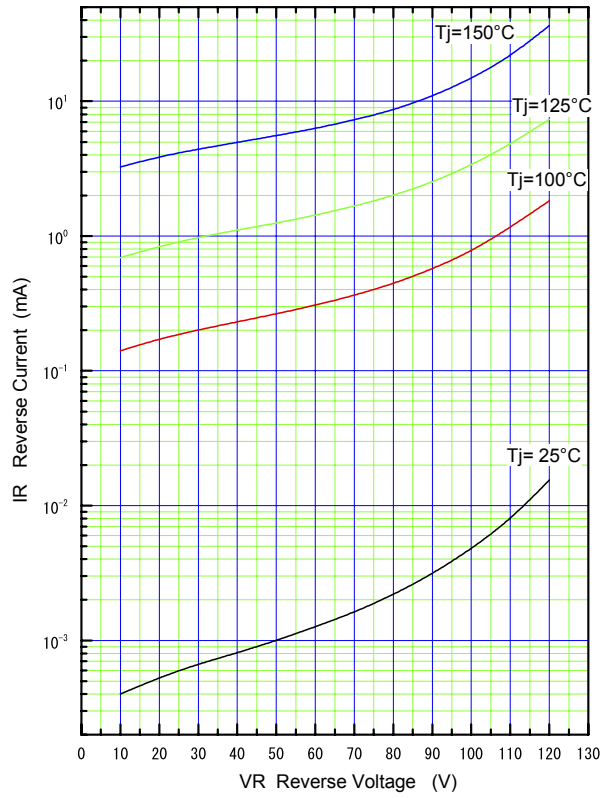

Forward Power Dissipation (max.)

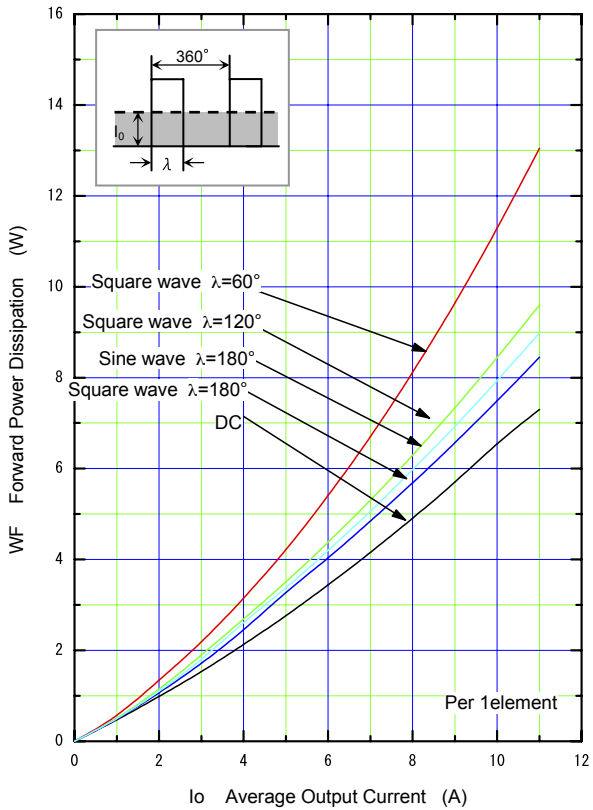

Reverse Power Dissipation (max.)

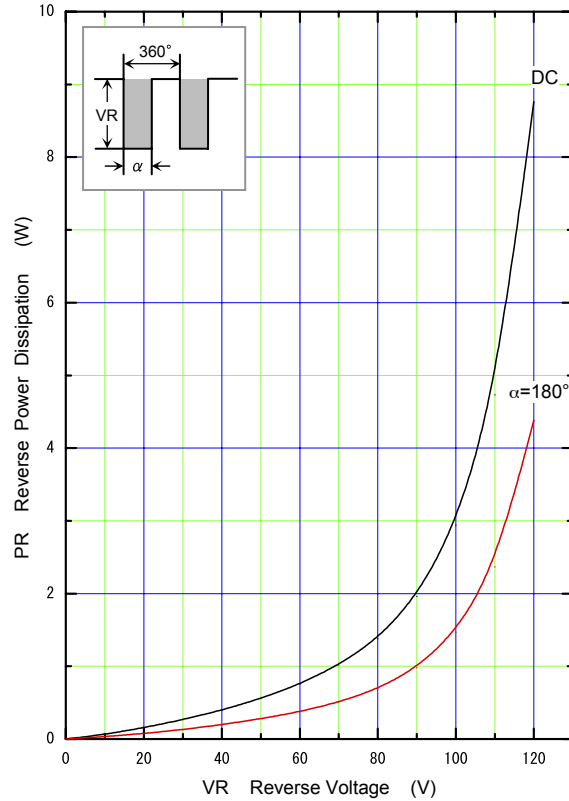

Current Derating (I_o - T_c) (max.)

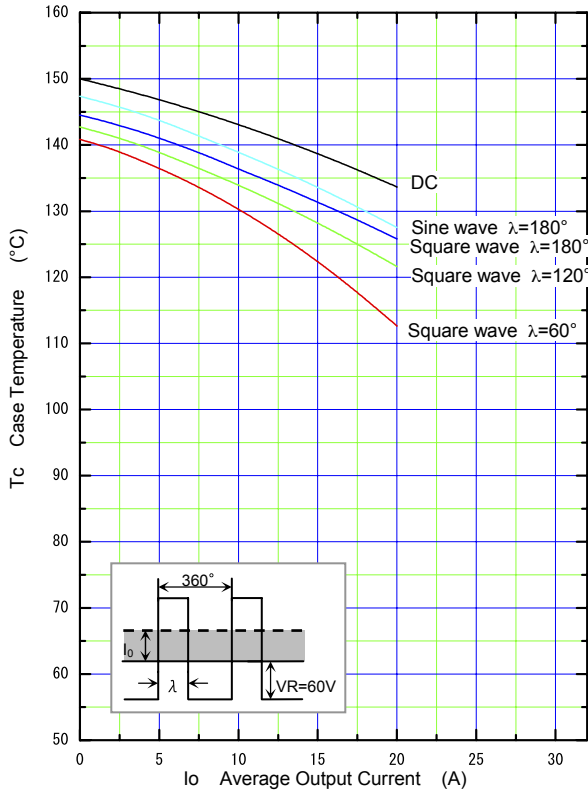

λ : Conduction angle of forward current for each rectifier element
 I_o : Output current of center-tap full wave connection

Junction Capacitance Characteristic (max.)

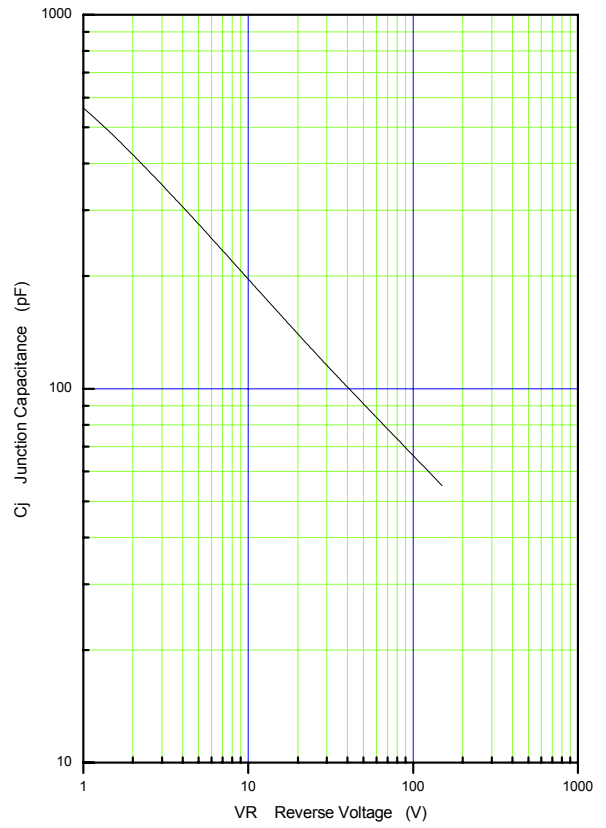

Surge Capability (max.)

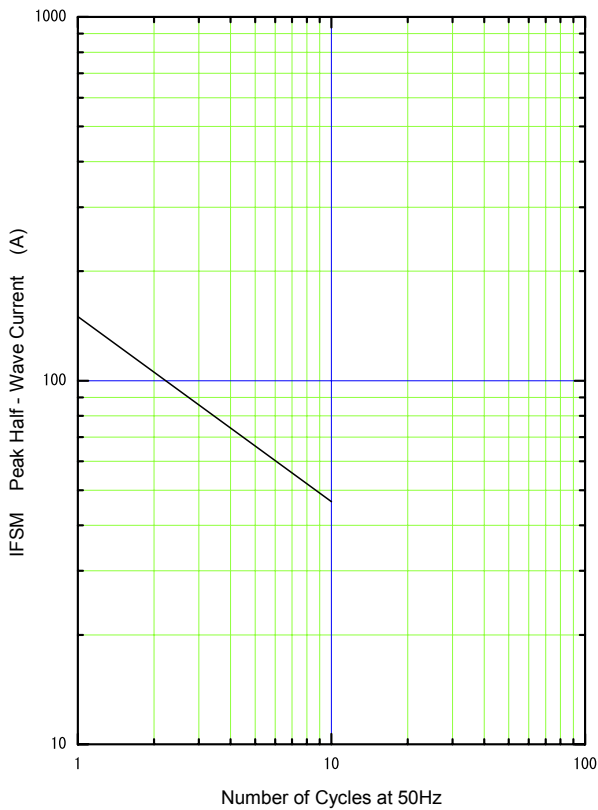

Transient Thermal Impedance (max.)

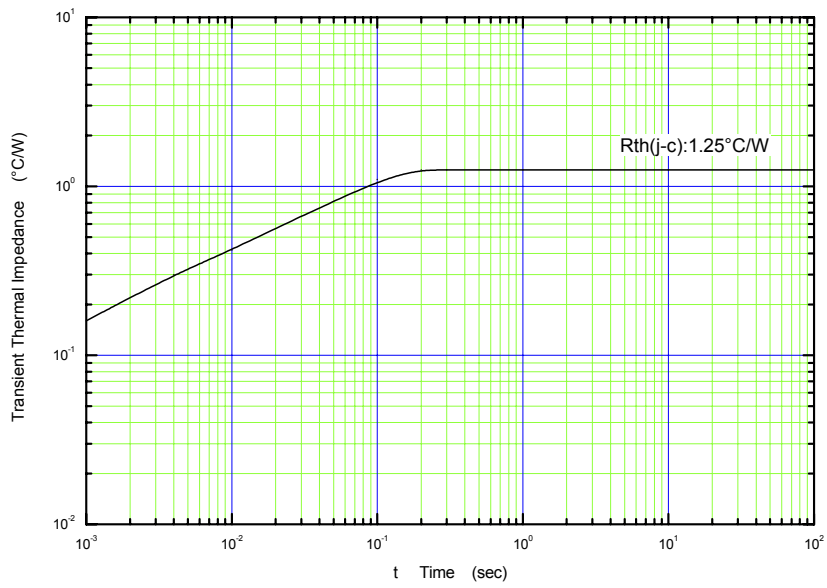

WARNING

1. This Catalog contains the product specifications, characteristics, data, materials, and structures as of March 2010. The contents are subject to change without notice for specification changes or other reasons. When using a product listed in this Catalog, be sure to obtain the latest specifications.
2. All applications described in this Catalog exemplify the use of Fuji's products for your reference only. No right or license, either express or implied, under any patent, copyright, trade secret or other intellectual property right owned by Fuji Electric Systems Co., Ltd. is (or shall be deemed) granted. Fuji Electric Systems Co., Ltd. makes no representation or warranty, whether express or implied, relating to the infringement or alleged infringement of other's intellectual property rights which may arise from the use of the applications described herein.
3. Although Fuji Electric Systems Co., Ltd. is enhancing product quality and reliability, a small percentage of semiconductor products may become faulty. When using Fuji Electric semiconductor products in your equipment, you are requested to take adequate safety measures to prevent the equipment from causing a physical injury, fire, or other problem if any of the products become faulty. It is recommended to make your design fail-safe, flame retardant, and free of malfunction.
4. The products introduced in this Catalog are intended for use in the following electronic and electrical equipment which has normal reliability requirements.
 - Computers • OA equipment • Communications equipment (terminal devices) • Measurement equipment
 - Machine tools • Audiovisual equipment • Electrical home appliances • Personal equipment • Industrial robots etc.
5. If you need to use a product in this Catalog for equipment requiring higher reliability than normal, such as for the equipment listed below, it is imperative to contact Fuji Electric Systems Co., Ltd. to obtain prior approval. When using these products for such equipment, take adequate measures such as a backup system to prevent the equipment from malfunctioning even if a Fuji's product incorporated in the equipment becomes faulty.
 - Transportation equipment (mounted on cars and ships) • Trunk communications equipment
 - Traffic-signal control equipment • Gas leakage detectors with an auto-shut-off feature
 - Emergency equipment for responding to disasters and anti-burglary devices • Safety devices
 - Medical equipment
6. Do not use products in this Catalog for the equipment requiring strict reliability such as the following and equivalents to strategic equipment (without limitation).
 - Space equipment • Aeronautic equipment • Nuclear control equipment
 - Submarine repeater equipment
7. Copyright ©1996-2008 by Fuji Electric Systems Co., Ltd. All rights reserved.
No part of this Catalog may be reproduced in any form or by any means without the express permission of Fuji Electric Systems Co., Ltd.
8. If you have any question about any portion in this Catalog, ask Fuji Electric Systems Co., Ltd. or its sales agents before using the product.
Neither Fuji Electric Systems Co., Ltd. nor its agents shall be liable for any injury caused by any use of the products not in accordance with instructions set forth herein.