

TS865C12R (20A)

(120V / 20A)

[0402]

High Voltage Schottky barrier diode

Major characteristics

Characteristics	TS865C12R	Units	Condition
V _{RRM}	120	V	
V _F	0.88	V	T _c =25°C MAX.
I _o	20	A	

Features

- Low V_F
- High Voltage
- Center tap connection

Applications

- High frequency operation
- DC-DC converters
- AC adapter

Maximum ratings and characteristics

- Absolute maximum ratings (at T_c=25°C Unless otherwise specified)

Item	Symbol	Conditions	Rating	Unit
Repetitive peak surge reverse voltage	V _{RSM}	tw=500ns, duty=1/40	120	V
Repetitive peak reverse voltage	V _{RRM}		120	V
Average output current	I _o	Square wave, duty=1/2 T _c =126°C	20 *	A
Non-repetitive surge current **	I _{FSM}	Sine wave 10ms 1shot	150	A
Operating junction temperature	T _j		+150	°C
Storage temperature	T _{stg}		-40 to +150	°C

* Out put current of center tap full wave connection

**Rating per element

- Electrical characteristics (at T_c=25°C Unless otherwise specified)

Item	Symbol	Conditions	Max.	Unit
Forward voltage drop	V _F	I _{FM} =10A	0.88	V
Reverse current	I _R	V _R =V _{RRM}	150	μA
Thermal resistance	R _{th(j-c)}	Junction to case	1.25	°C/W

- Mechanical characteristics

Approximate mass		2	g
------------------	--	---	---

Outline drawings, mm

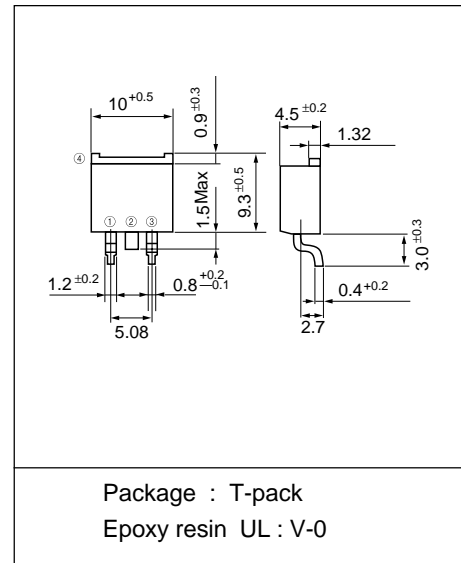

Connection diagram

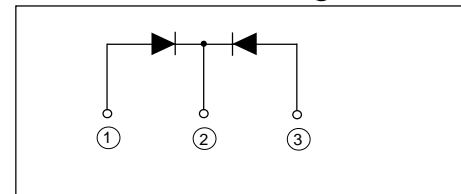

■ Characteristics

Forward Characteristic (typ.)

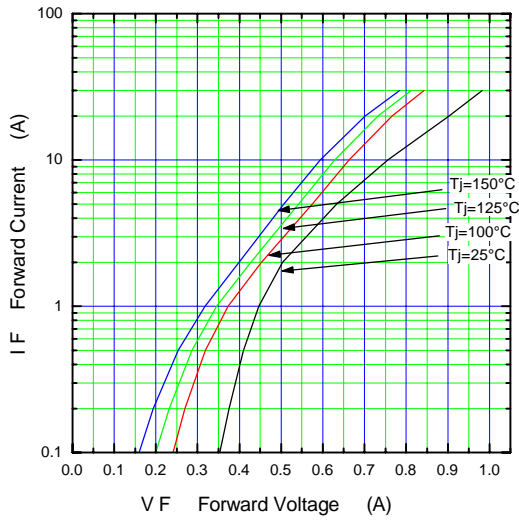

Reverse Characteristic (typ.)

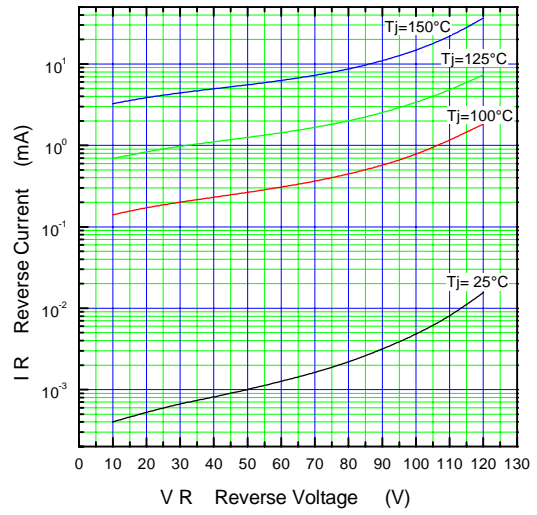

Forward Power Dissipation (max.)

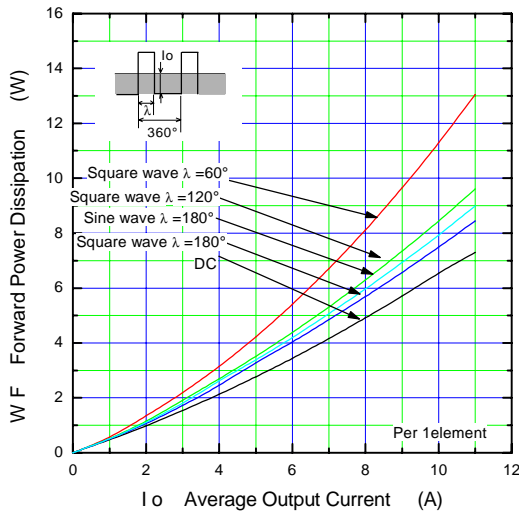

Reverse Power Dissipation (max.)

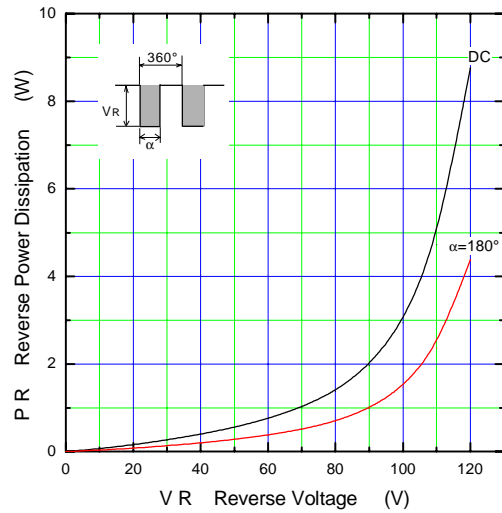

Current Derating (I_o-T_c) (max.)

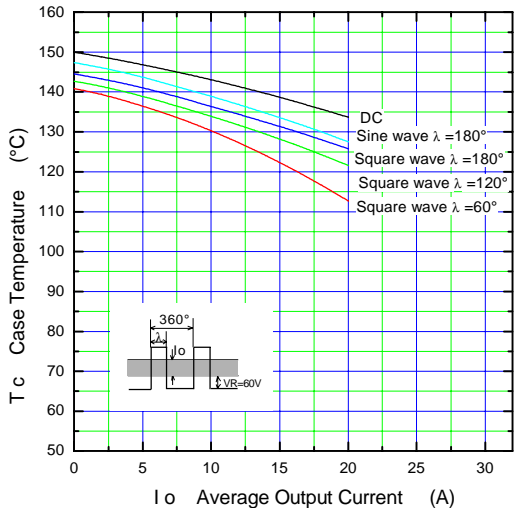

Junction Capacitance Characteristic (max.)

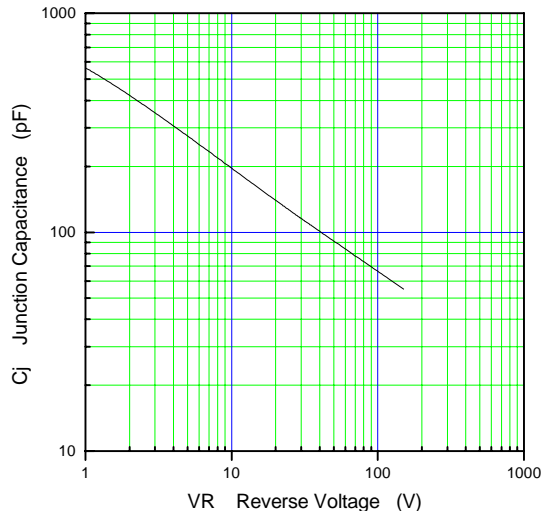

λ: Conduction angle of forward current for each rectifier element
I_o: Output current of center-tap full wave connection

Surge Capability (max.)

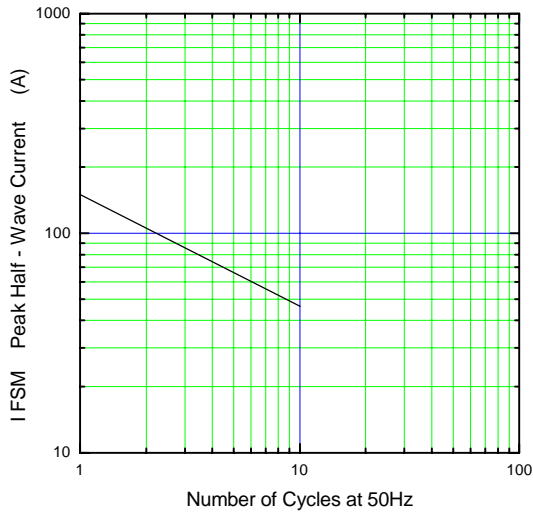

Surge Current Ratings (max.)

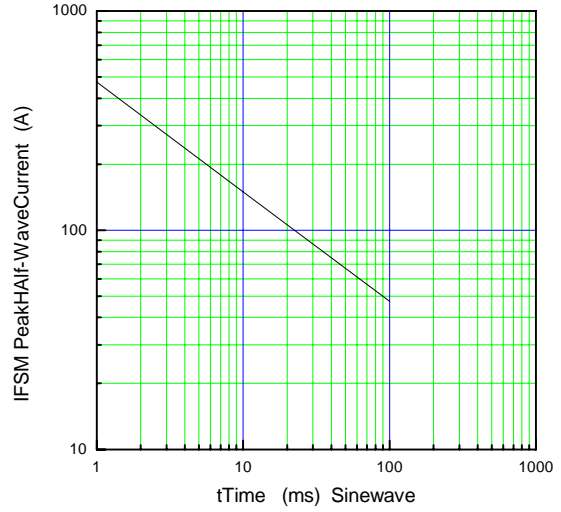

Transient Thermal Impedance (max.)

